

 Roland

MT-32

MULTI TIMBRE SOUND MODULE

Owner's Manual

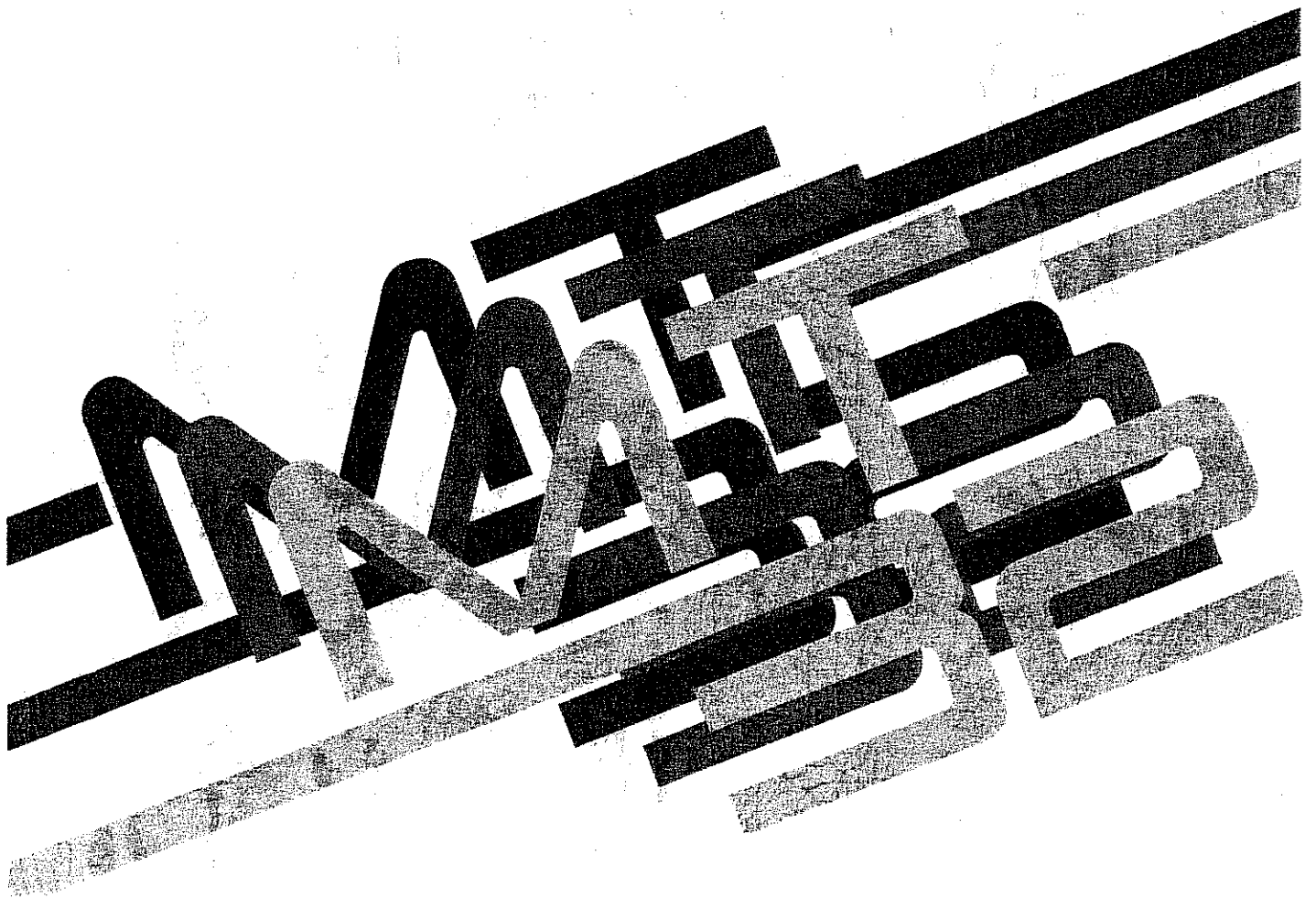

Bescheinigung des Herstellers /Importeurs

Hiermit wird bescheinigt, daß der/die/das

ROLAND MULTI - TIMBRE SOUND MODULE MT-32

(Gerät, Typ, Berechnung)

in Übereinstimmung mit den Bestimmungen der

Amtsbl. Vfg 1046 / 1984

(Amplifierverfügung)

funk-entstört ist.

Der Deutschen Bundespost wurde das Inverkehrbringen dieses Gerätes angezeigt und die Berechtigung zur Überprüfung der Serie auf Einhaltung der Bestimmungen eingeräumt.

Roland Corporation Osaka / Japan

Name des Herstellers/Importeurs

RADIO AND TELEVISION INTERFERENCE

Warning - This equipment has been verified to comply with the limits for a Class B computing device, pursuant to Subpart J, of Part 15, of FCC rules. Operation with non-certified or non-verified equipment is likely to result in interference to radio and TV reception.

The equipment described in this manual generates and uses radio-frequency energy. If it is not installed and used properly, that is, in strict accordance with our instructions, it may cause interference with radio and television reception.

This equipment has been tested and found to comply with the limits for a Class B computing device in accordance with the specifications in Subpart J, of Part 15, of FCC Rules. These rules are designed to provide reasonable protection against such a interference in a residential installation. However, there is no guarantee that the interference will not occur in a particular installation. If this equipment does cause interference to radio or television reception, which can be determined by turning the equipment on and off, the user is encouraged to try to correct the interference by the following measure:

- Disconnect other devices and their input/output cables one at a time. If the interference stops, it is caused by either the other device or its I/O cable. These devices usually require Roland designated shielded I/O cables. For Roland devices, you can obtain the proper shielded cable from your dealer. For non-Roland devices, contact the manufacturer or dealer for assistance.

If your equipment does cause interference to radio or television reception, you can try to correct the interference by using one or more of the following measures:

- Turn the TV or radio antenna until the interference stops.
- Move the equipment to one side or the other of the TV or radio.
- Move the equipment farther away from the TV or radio.
- Plug the equipment into an outlet that is on a different circuit than the TV or radio. (That is, make certain the equipment and the radio or television set are on circuits controlled by different circuit breakers or fuses.)
- Consider installing a rooftop television antenna with coaxial cable lead-in between the antenna and TV.

If necessary, you should consult your dealer or an experienced radio/television technician for additional suggestions. You may find helpful the following booklet prepared by the Federal Communications Commission:

"How to Identify and Resolve Radio-TV Interference Problems"
This booklet is available from the U.S. Government Printing Office, Washington, D.C. 20402, Stock No. D08-500-003-9-4.

Please read the separate volume 'MIDI', before reading this owner's manual.

Copyright © 1987 by ROLAND CORPORATION

All rights reserved. No part of this publication may be reproduced in any form without the written permission of ROLAND CORPORATION.

CONTENTS

Thank you for purchasing the Roland MT-32 Multi-Timbre Sound Module.

The MT-32 fully conforms to Musical Instrument Digital Interface (MIDI) standards, which define data exchange between electronic musical instruments and devices.

The MT-32 operates in conjunction with the Roland Piano, piano recorder, digital sequencer, and other MIDI-compatible sound sources.

Study this Owner's Manual and keep it handy so that the MT-32 can provide you with many years of musical enjoyment.

CONTENTS

PANEL DESCRIPTION	2
CARE AND MAINTENANCE	4
Power Supply	4
Connection	4
Power-on Procedure	4
Installation	5
Cleaning	5
Cautions	5
1. FEATURES AND USE	6
2. USING THE MT-32 WITH ROLAND SOFTWARE	8
3. USING THE MT-32 WITH ORIGINAL DATA	10
ROM PLAY	27
MAJOR SPECIFICATIONS	28

PANEL DESCRIPTION

1. Front Panel

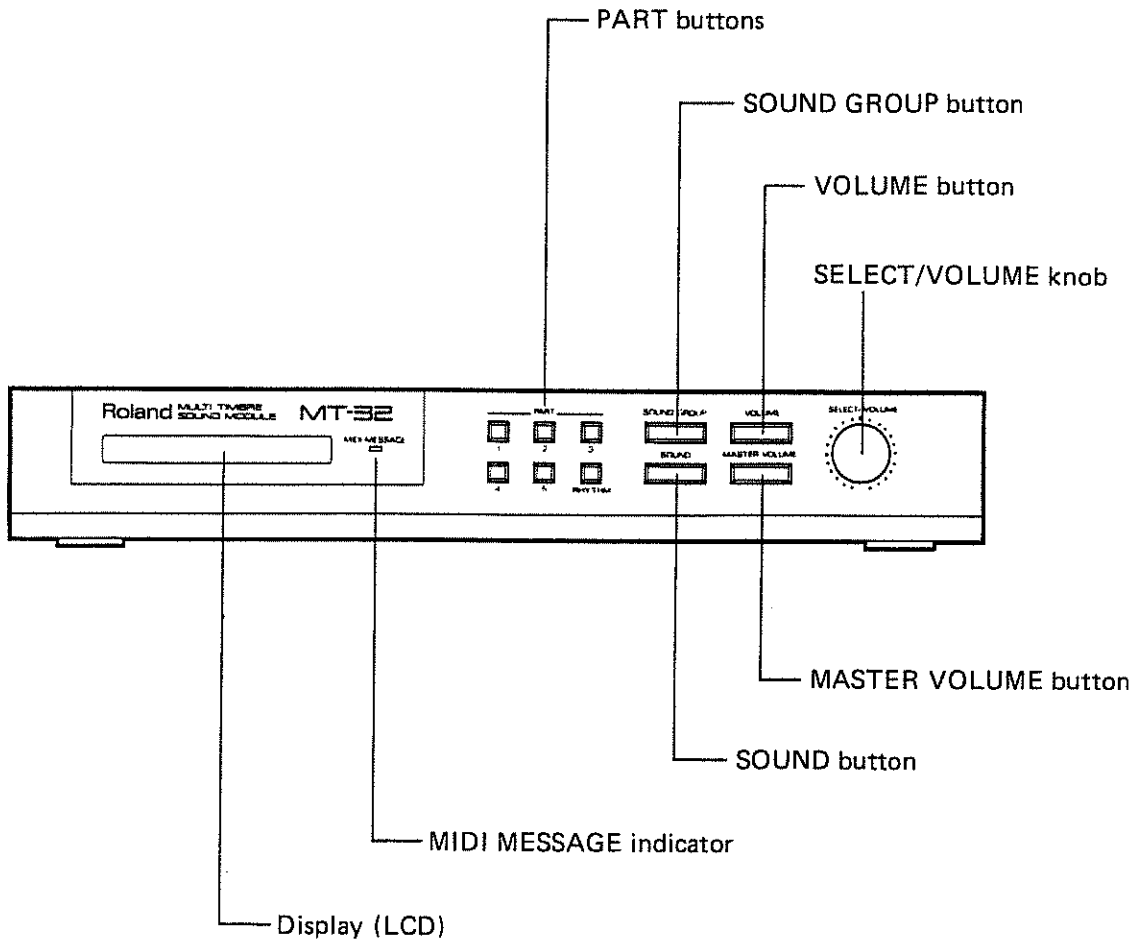

2 Rear Panel

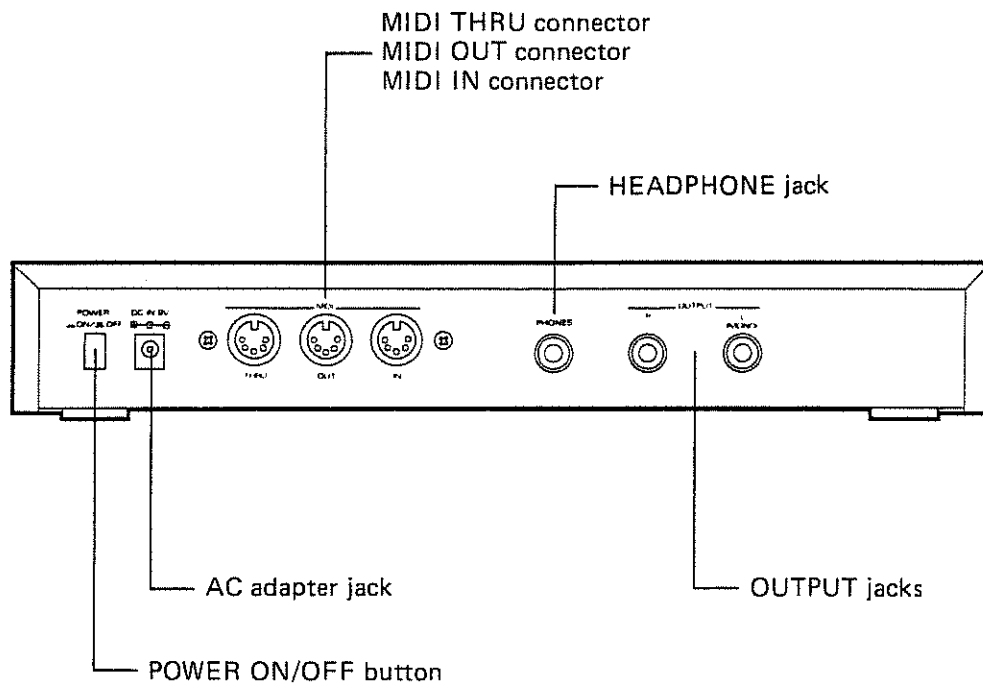

CARE AND MAINTENANCE

POWER SUPPLY

- Be sure to use the AC adapter that comes with the MT-32. Use of a non-standard adapter could lead to errors and breakdowns.
- For use in a region where voltage requirements are different, consult with your nearest Roland sales representative about the ACB-100, ACB-120, ACB-220, or ACB-240 AC adapter.
- Do not use the MT-32 on the same power outlet as a motor, dimmer, or any other equipment that generates noise or consumes a large amount of power.
- Connect the AC adapter to the MT-32's DC IN jack before inserting the power plug in the power outlet.
- Make sure that the MT-32 is turned off before connecting the AC adapter to the power outlet.
- When disconnecting the AC adapter from the power outlet, be sure to pull the power plug itself and not the power cord, to avoid damaged and short-circuiting.
- Avoid damaging the power cord.
- If the MT-32 is not being used for a prolonged period, disconnect the AC adapter from the power outlet.

CONNECTION

- Make sure that all switches are off before setting up or changing equipment connections.

POWER-ON PROCEDURE

- The MT-32 may not operate correctly if you turn it on immediately after a shutdown or connect it to a power outlet with the POWER switch on. If this happens, turn the POWER switch off, then turn it back on several seconds later.
- Set amplifier volume to 0 when turning the power on and off. Too high a volume level will result in an overload, which can damage the speakers.

INSTALLATION

- To prevent adverse effects, protect your MT-32 from:
 - Direct sunlight
 - Temperature and humidity extremes (heaters, etc.)
 - Dust
 - Vibration
- Do not place the MT-32 near a neon tube, fluorescent lamp, television set, cathode-ray tube, or other such equipment that could cause noise interference or errors.

CLEANING

- For daily care, wipe the casing with a dry, soft cloth.
- If the casing is stained, use a cloth slightly dampened with water.
- To remove stubborn stains, clean the casing with a cloth coated with a neutral detergent, then wipe it dry with a soft cloth.
- Never use paint thinners, benzine, or other organic solvents which could damage the casing.

CAUTIONS

- Adjust volume control to a level that will not disturb the neighborhood, especially at night when sounds can travel over a long distance.
- Do not allow fluid or foreign matter, such as water, beverages, coins, and wires, to enter the MT-32.
- Do not examine or modify the internal components or circuitry. Electrical shocks or damage may result.
- Do not subject the MT-32 to a severe impact, nor move it while the power is on.
- If the MT-32 fails to operate correctly, turn off immediately and contact your nearest Roland service representative.

HOW TO USE MT-32 FEATURES

1. FEATURES AND USE

The MT-32 multi-timbre sound module contains a sound source capable of supplying eight independent parts and thirty rhythm sounds.

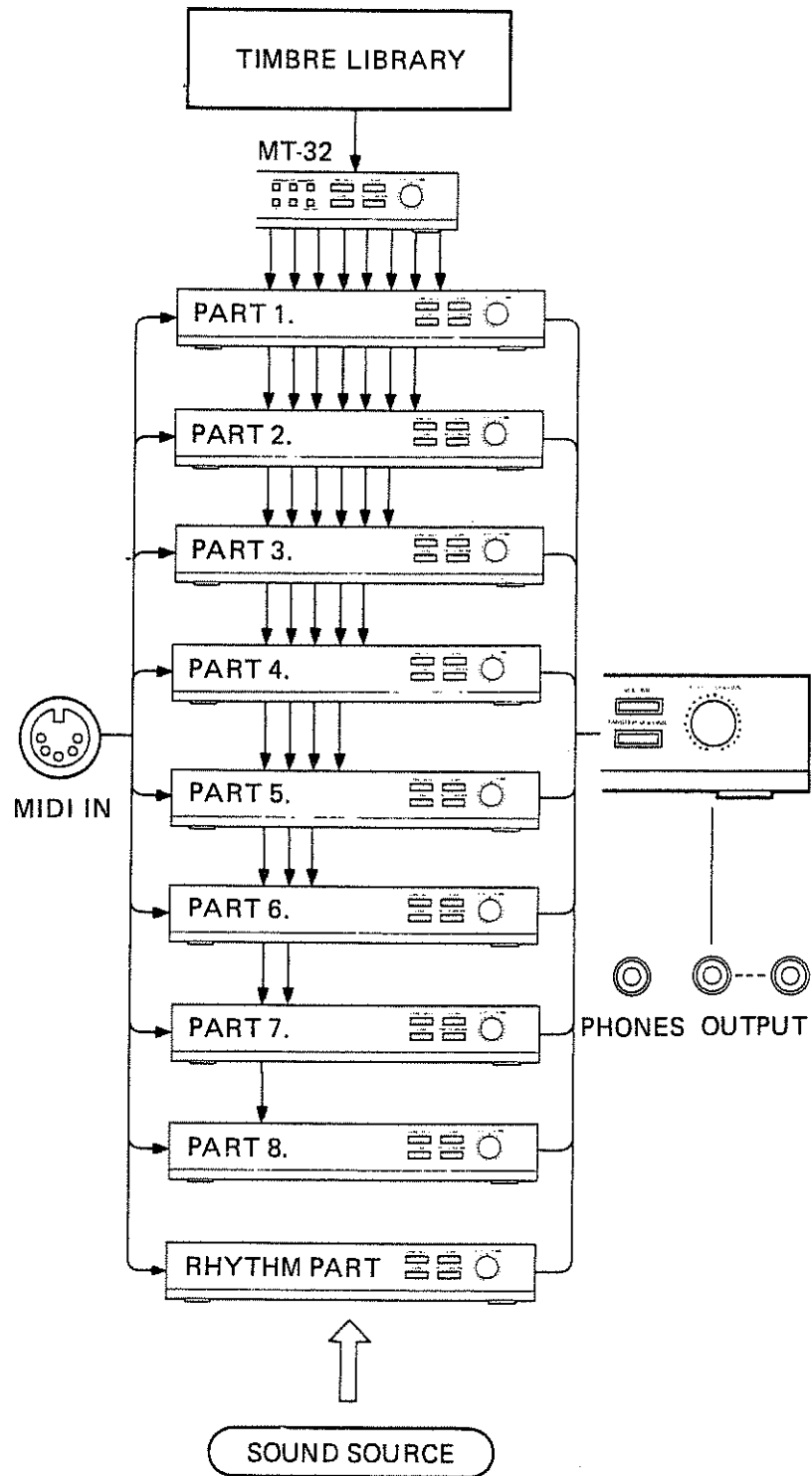

The MT-32 incorporates a 128-timbre sound library that lets you select sounds for any of the non-rhythm parts.

The sound source block allows you to play up to thirty-two notes for the eight parts simultaneously, each of which may consist of any number of notes within the upper limit. (The exact voicing capacity allowed, however, varies with the timbres you select. See page 22 for details.)

The MT-32 works in conjunction with a MIDI keyboard, sequencer (a device that stores musical data for playback at the desired timing), and other instruments that generate MIDI data.

The MT-32 applications are roughly broken down into the following two categories. See the corresponding section for a full explanation.

- (1) Using the MT-32 with the Roland Piano, the Roland PR-100 Digital Sequencer, and Roland PR-100 Pre-Recorded Software
→ See Section [2] "USING THE MT-32 WITH ROLAND PR-100 PRE-RECORDED SOFTWARE" (page 8).
- (2) Using the MT-32 with a sequencer loaded with your own data
→ See Section [3] "USING THE MT-32 WITH ORIGINAL DATA" (page 10).

2. USING THE MT-32 WITH ROLAND PR-100 PRE-RECORDED SOFTWARE

When using the MT-32 with the Roland Piano, Roland PR-100 Digital Sequencer, and Roland PR-100 Software, connect the instruments as shown below:

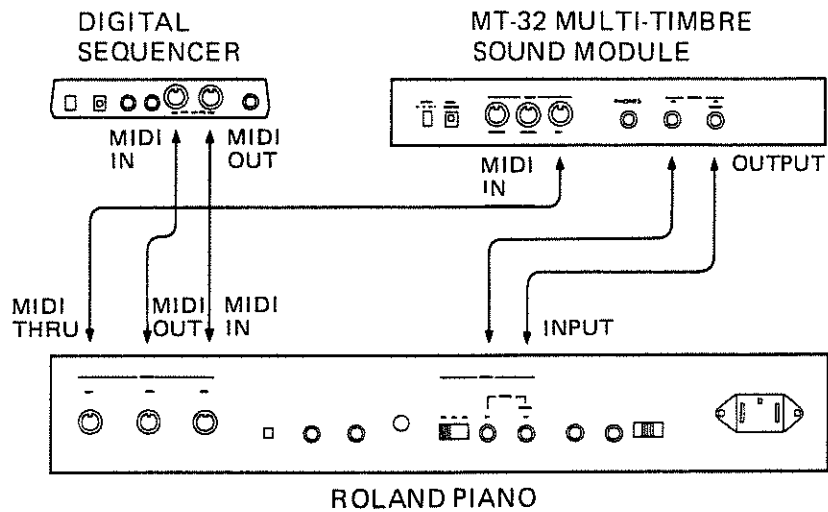

When connections are complete, turn on the piano, MT-32, then the PR-100. Follow the instructions given in the PR-100 and software manuals.

*Set SOFT THRU ON on the sequencer, and set LOCAL OFF (→ "O" position) on the Roland Piano.

*To send MT-32 output to the built-in speaker of the Roland Piano, set the Roland Piano input level switch to the high position.

*Even when headphones are connected to the Headphone Jack on the MT-32, signal is still output from the output jacks.

The following two steps are all that is required to set up the MT-32:

● MASTER VOLUME

Set the overall volume level of the MT-32.

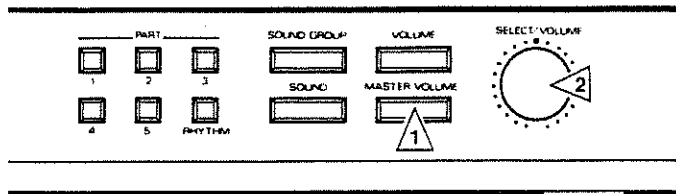

(1) Press the MASTER VOLUME button, (2) then adjust with the SELECT/VOLUME control.

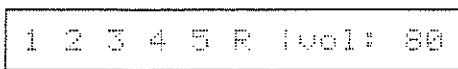

* If the sound is distorted, lower the volume.

* If the reading on the display remains unchanged when the SELECT/VOLUME knob is turned, turn the knob counterclockwise until the volume number in the display begins to change, then readjust.

(To prevent any sudden change in output level, the SELECT/VOLUME control must be turned to the position of output level as shown in the display before any adjustment can be made.)

● REVERB MODE

Select the reverb mode as necessary for the master output from the MT-32.

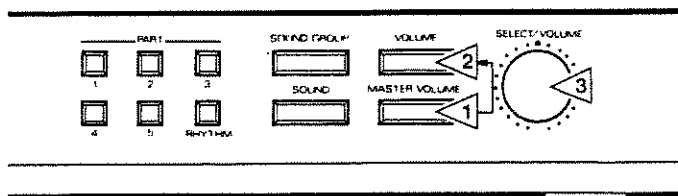

(1) While holding down the MASTER VOLUME button and (2) press the VOLUME button, then (3) turn the SELECT/VOLUME control to adjust the reverb depth mode.

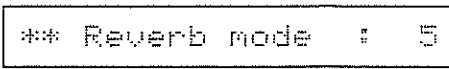

* The reverb mode will not effect any part which the Reverb has been disabled by software.

More functions are available to the user, but they may not provide noticeable effects if the MT-32 is controlled by software. The software overrides user-defined settings when there is a parameter conflict.

3 USING THE MT-32 WITH ORIGINAL DATA

Working knowledge of MIDI implementation is necessary if you intend to compile your own sequencer data to play on the MT-32. Study the separate volume "What is MIDI" before starting.

Connect the equipment as shown below:

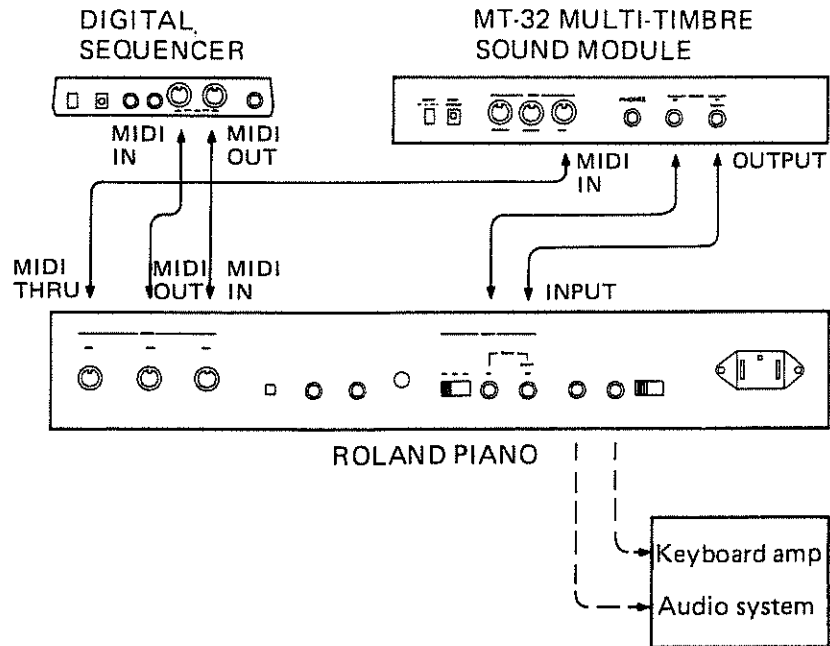

*If the keyboard does not have a MIDI THRU port, use the following connection:

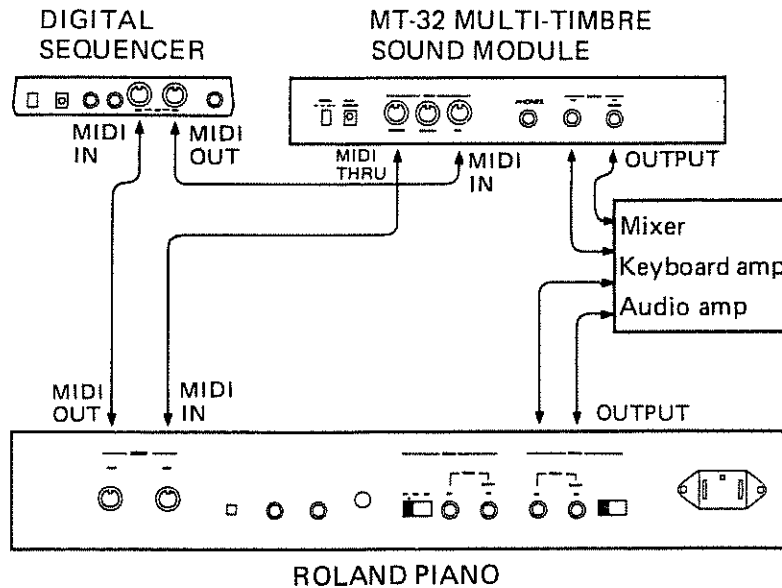

* Always turn on the piano, MT-32 before turning on the sequencer.

* Even when headphones are connected to the Headphone Jack on the MT-32, signal is still output from the output jacks.



Not all of the MT-32 features are available unless the sequencer used is capable of generating data that allows access to such functions. Essential requirements are that either (1) the keyboard for compiling data or (2) the sequencer alone allows you to produce data compatible with the MT-32.

In short, the exact functions that the MT-32 provides vary with the performance of the sequencer and the keyboard you are going to use.

The sections that follow explain how the MT-32 responds to data from a MIDI source. For the data specifications and data exchange procedures, refer to the manuals for the sequencer and keyboard.

*Set SOFT THRU ON on the sequencer, and set LOCAL OFF (→“:” position) on the Roland Piano.

	Page
1. Built-in Functions	12
2. User-accessible Functions	15
3. Functions Accessible with an External MIDI Message . .	20
a. Program Change and Control Change	20
b. MIDI System Exclusive Messages	21
(1) Overall Control for the MT-32 Functions	22
(2) Control over Parts 1 to 8	23
(3) Writing User Patches to Memory	24
(4) Timbre Control	25
(5) Writing Timbre Data to Memory	26
(6) Rhythm Part Control	26
(7) Data Transfer	26

1. BUILT-IN FUNCTIONS

This section explains the MT-32's built-in functions.

● MIDI CHANNELS

The following is the default channel configuration for the nine parts. The MT-32 checks the channels used to compile data when determining the parts it will play.

Part	1	2	3	4	5	6	7	8	Rhythm
Channel	2	3	4	5	6	7	8	9	10

The channel configuration can be switched to the following:

Part	1	2	3	4	5	6	7	8	Rhythm
Channel	1	2	3	4	5	6	7	8	10

PROCEDURE

Press PART button 5 while holding down the MASTER VOLUME button, then press PART button 1.

*The rhythm setting (Channel 10) remains unchanged.

Following is a list of Rhythm instrument voices contained in the MT-32 with the note number assigned to each voice.

	(76)
(75) Claves	(74)
(73) Quijada	(72) Smba Whis L
	(71) Smba Whis S
(70) Maracas	(69) Cabasa
(68) Low Agogo	(67) High Agogo
(66) Low Timbale	(65) High Timbale
	(64) Low Conga
(63) High Conga	(62) Mt High Conga
(61) Low Bongo	(60) High Bongo
	(59)
(58)	(57)
(56) Cowbell	(55)
(54) Tambourine	(53)
	(52)
(51) Ride Cym	(50) Acou Hi Tom
(49) Crash Cym	(48) Acou Hi Tom
	(47) Acou Mid Tom
(46) Open Hi Hat 1	(45) Acou Mid Tom
(44) Open Hi Hat 2	(43) Acou Low Tom
(42) Clsd Hi Hat	(41) Acou Low Tom
	(40) Elec SD
(39) Hand Clap	(38) Acou SD
(37) Rim Shot	(36) Acou BD
	(35) Acou BD

The numbers in () are the Key numbers.

• STEREO BALANCE IN THE PHYTHM PART

(Stereo balance)

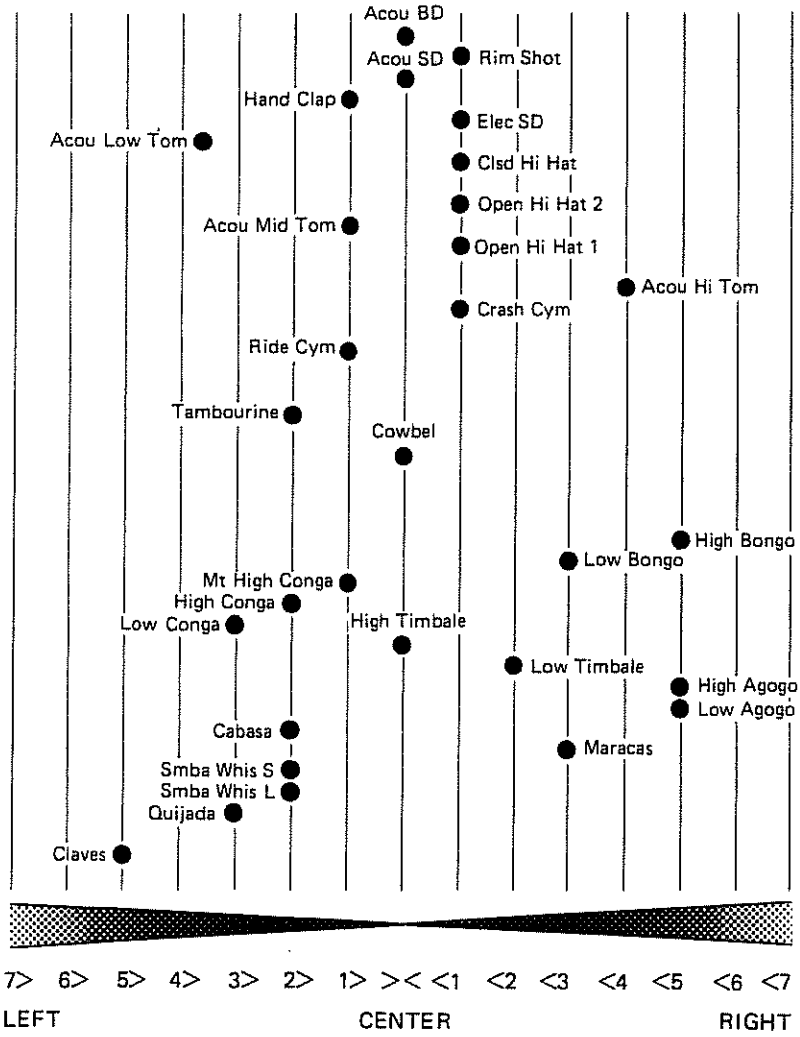

2. USER-ACCESSIBLE FUNCTIONS

This section explains the functions that are accessible to the player using the MT-32's control panel.

OVERALL FUNCTIONS

● MASTER VOLUME

This function determines the overall output level from the MT-32.

PROCEDURE

Press the MASTER VOLUME button, then adjust with the SELECT/VOLUME control.

Adjustable range: 0 (min volume) to 100 (max volume)

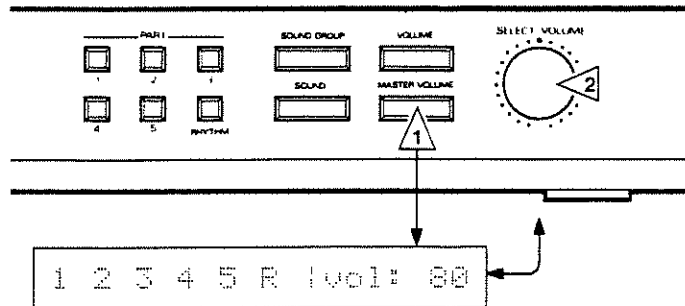

The part currently played continues flashing.

* If the sound is distorted, lower the volume.

* If the reading on the display remains unchanged when the SELECT/VOLUME control is turned, turn the control counter-clockwise until the volume number in the display begins to change, then readjust.

(To prevent any sudden change in output level, the SELECT/VOLUME control must be turned to the position of output level as shown in the display before any adjustment can be made.)

● UNIT NUMBER

This function changes the unit number, which identifies the MT-32 receiving a System Exclusive message. The unit number should not be changed in regular MT-32 applications.

PROCEDURE

Press the SOUND button while holding down the MASTER VOLUME button, then turn the SELECT/VOLUME control to change the unit number.

Adjustable range: 1 to 32

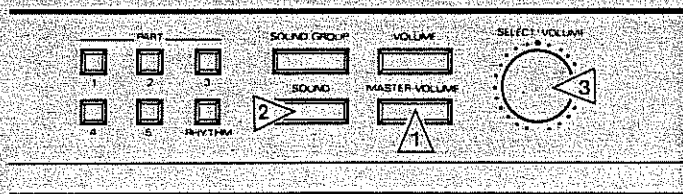

● MASTER TUNING

This function adjusts the pitch of the overall output from the MT-32. It is used to tune the MT-32 to the other instruments.

PROCEDURE

Press the SOUND GROUP button while holding down the MASTER VOLUME button, then turn the SELECT/VOLUME control to adjust the master tuning.

Adjustable range:

427.5 to 452.6 Hz (Standard pitch: A = 442 Hz)

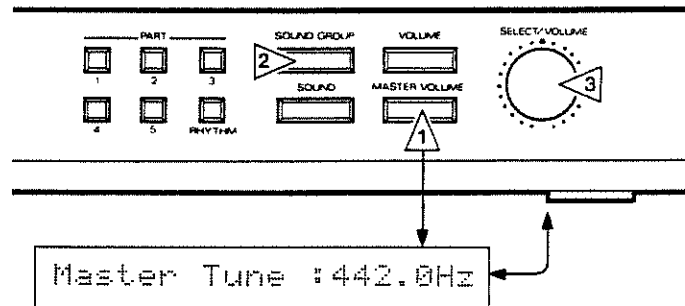

● REVERB MODE

Select the reverb mode as necessary for the overall output from the MT-32.

PROCEDURE

Press the SOUND GROUP button while holding down the MASTER VOLUME button, then turn the SELECT/VOLUME control to adjust the reverb mode.

Adjustable range: 0 – 10

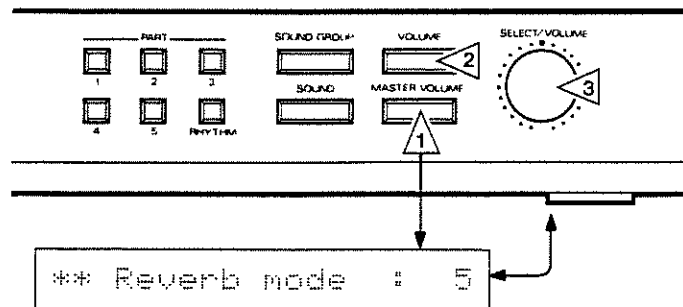

● OVERFLOW ASSIGN

This function allows the MT-32 to generate MIDI notes beyond its capacity and send the excess out of the MIDI OUT port to the input of an additional external MIDI instrument.

PROCEDURE

Press PART button 4 while holding down the MASTER VOLUME button, then press PART button 1.

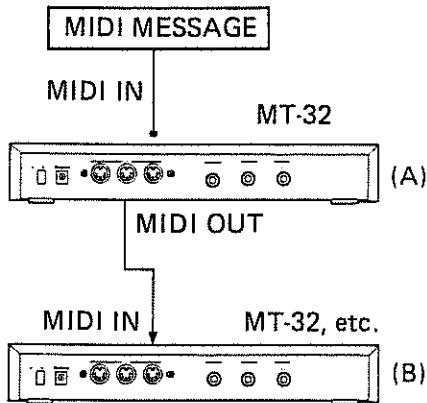

Module (A) sends excess data from its MIDI OUT port to module (B) for remote output.

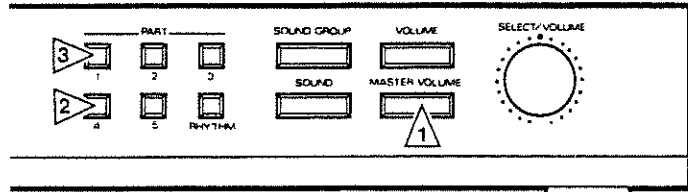

Overflow Assign? [1]

* This function remains in effect until you turn off the MT-32.

● ALL RESET

This function resets all the current settings and initialized the MT-32 to the power-on defaults. It is useful when a sound remains on after you have stopped playing MIDI data part way through.

PROCEDURE

Press PART button RHYTHM while holding down the MASTER VOLUME button, then press PART button 1.

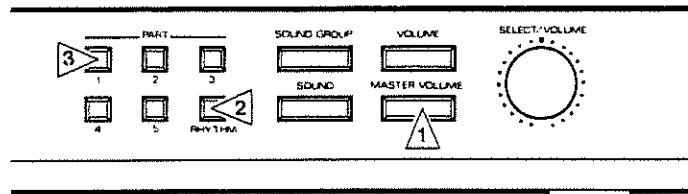

** All Reset OK? [1]

* If you press one of PART buttons between 2 and 5 instead of PART button 1, the MT-32 will reset all settings except for the patch memory and rhythm setup functions.

————— PART FUNCTIONS —————

● TIMBRE SETUP

The MT-32 comes with an internal 128-timbre data library that lets you select sounds for any of the non-rhythm parts.

→ Refer to the separate volume "Sound List" for a full description of the timbres.

The 128 timbres are classified into separate sound groups, each containing from four to eleven timbres.

PROCEDURE

- (1) Press the PART button that corresponds to the part for which you wish to select the timbre. (You can select parts 6, 7, 8, by pressing part switches 1, 2, 3 while pressing MASTER VOLUME switch.)

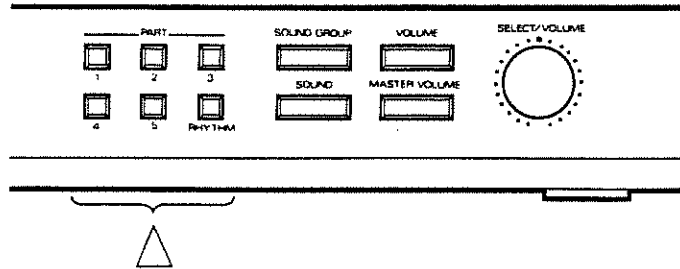

- (2) Press the SOUND GROUP button, then select the sound group you desire with the SELECT/VOLUME control.

```
1>Piano  |AcouPiano|
```

FLASHING

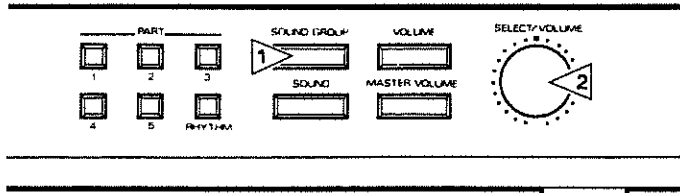

```
1|Piano  >AcouPiano|
```

FLASHING



```
1|Piano  >*****|
```

NAME OF TIMBRE

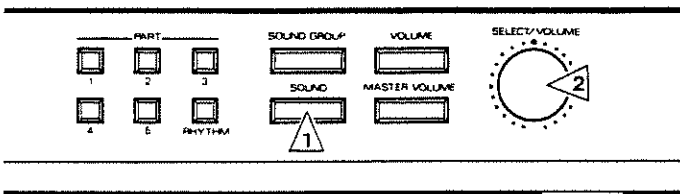

● VOLUME FOR EACH PART

This function allows independent volume control for each part, including the rhythm part.

PROCEDURE

- (1) Press the PART button that corresponds to the part for which you wish to adjust the volume.

```
*|*****|vol> 80
```

PART NAME OF FLASHING
TIMBRE

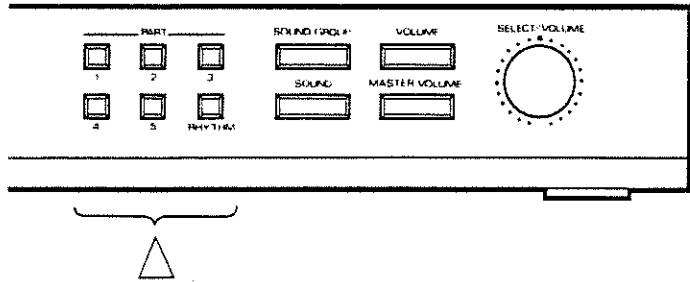

- (2) Press the VOLUME button, then set the volume with the SELECT/VOLUME control.
Adjustable range: 0 – 100

```
*|* |vol>***
```

VOLUME

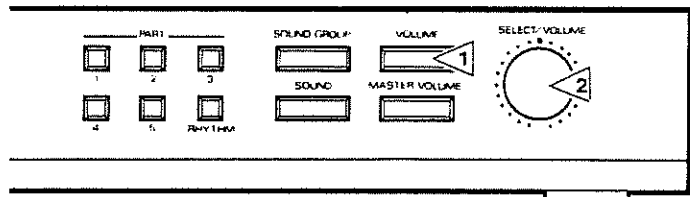

* Keep the volume for each part low enough to avoid overloading or noise interference.

* If the reading on the display remains unchanged when the SELECT/VOLUME control is turned, turn the knob counter-clockwise until the volume number in the display begins to change, then readjust.

(To prevent any sudden change in output level, the SELECT/VOLUME control must be turned to the position of output level as shown in the display before any adjustment can be made.)

3. FUNCTIONS ACCESSIBLE WITH AN EXTERNAL MIDI MESSAGE

a. Program Change and Control Change

The MT-32 accepts external MIDI messages (Program Change and Control Change) which redefine the MT-32 settings. These messages provide independent control over any of the non-rhythm parts.

● TIMBRE SETUP (PROGRAM CHANGE)

This function allows the MT-32 to select the timbre as specified by an external Program Change number (a superscript appearing to the left of the timbres in the "Sound List").

*The timbre setup procedure using a Program Change number differs from the one using the MT-32 control panel. See page 23 for details.

● MODULATION DEPTH (CONTROL CHANGE [1])

This function changes the vibrato effect.

● VOLUME LEVEL FOR EACH PART (CONTROL CHANGE [7])

This function sets the volume level for each part.

● PAN-POT (CONTROL CHANGE [10])

This function changes the stereo balance of the MT-32 output.

● EXPRESSION (CONTROL CHANGE [11])

This function controls sound dynamics.

*The sound dynamics can be controlled by the Expression and the volume level settings (as determined by the MT-32 control panel setting or Control Changes [7] and [11]).

● HOLD (CONTROL CHANGE [64])

This function causes the MT-32 to suspend control so that continuous notes maintain the sustain level and attenuating notes simulate the effect of a piano damper pedal.

b. MIDI System Exclusive Messages

The MT-32 accepts MIDI System Exclusive messages from an external controller (Keyboard, Computer, Sequencer etc.)

Because the data format for MIDI System Exclusive messages varies from one manufacturer to another, this data format must comply with the specifications designated by Roland when sent to the MT-32.

The MT-32 therefore does not accept System Exclusive messages unless the sequencer — whether it is manufactured by Roland or not — allows the user to compile messages from keypad, as with the Roland MC-500.

For details on the MIDI System Exclusive message and data input procedures, refer to MIDI implementation reference.

* For functions that allow access from the MT-32's control panel as well as Program Change and Control Change messages, the MT-32 retains the settings specified by the data last received.

1) OVERALL CONTROL FOR THE MT-32 FUNCTIONS

FUNCTION	DESCRIPTION	ADJUSTABLE RANGE
Master tuning	Changes the overall pitch of the MT-32.	432.1 to 457.6 Hz
Reverb mode	Selects the reverb type.	Room, Hall, Plate and Tap-delay
Reverb time	Sets the reverb duration.	1 to 8
Reverb level	Sets the reverb intensity.	0 to 7
Partial reserve (Parts 1 to 8 and rhythm)	(See below.)	0 to 32
MIDI channel (Parts 1 to 8 and rhythm)	Selects a MIDI channel for each part.	OFF or 1 to 16
Master volume	Sets the overall volume level for the MT-32.	0 to 100

○PARTIAL

The smallest unit that defines a timbre is called a "partial". While a single partial is enough to produce a simple tone, multiple partials are required to generate complex sounds.

Because the MT-32 is capable of generating up to thirty-two notes at a time, it requires exactly thirty-two partials to use its maximum capacity. The maximum capacity for generating notes simultaneously, therefore, reduces as the number of notes consisting of multiple partials increases.

○PARTIAL RESERVE

Partial Reserve is a function that allows the MT-32 to selectively define the number of partials that each part can use.

If a note requires partials beyond the upper limit of a part, the MT-32 will check the other parts for unused partials and allocate them, if available, to that part. If a part runs short of partials due to the Partial Reserve function, the MT-32 will terminate the part and send the partials back to the original part.

The Partial Reserve function thus ensures that every part has at least the number of partials assigned to it.

2) CONTROL OVER PARTS 1 TO 8

The Figure below shows musical data stored in memory together with the corresponding timbre data. A group of such data is called a "patch". A patch comes in 128 variations on the MT-32.

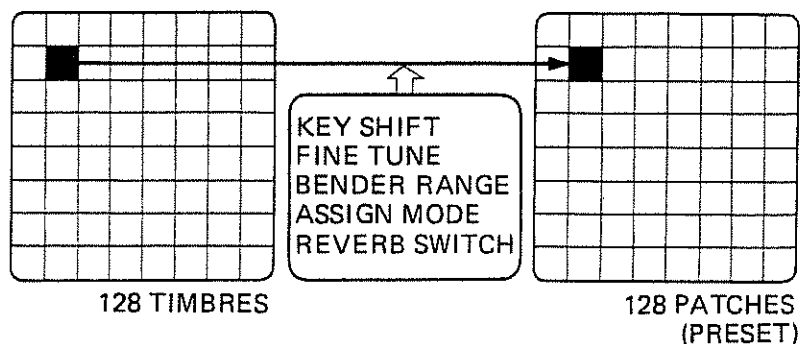

Unlike the "Timbre Setup" function (see page 18) that merely switches between different timbres, an externally supplied Program Change message causes the MT-32 to switch to the new patch and use the settings stored in that specified patch memory.

FUNCTION	DESCRIPTION	ADJUSTABLE RANGE
Sound group	Selects the sound group of timbres.	A, B, I, or R (1-30)
Sound number	Selects the timbre number.	1 to 64
Key shift	Indicates the actual shift relative to the note data.	-24 to +24 in semitones
Fine tune	Allows fine tuning.	-50 to 50 cents
Bender range	Sets the maximum effect of the Bender.	0 to 24
Assign mode	(See below.)	POLY 1, 2, 3, or 4
Reverb switch	Turns the reverb effect on and off.	ON or OFF

System Exclusive messages allow the user to freely edit the settings in such patch memories.

○ ASSIGN MODE

The assign mode determines how the MT-32 generates sounds in response to the note-on data it will receive:

- POLY 1: Polyphonic mode, single assign, priority given to data last received.
- POLY 2: Polyphonic mode, single assign, priority given to data first received.
- POLY 3: Polyphonic mode, multiple assign, priority given to data last received.
- POLY 4: Polyphonic mode, multiple assign, priority given to data first received.

SINGLE ASSIGN

This function causes the MT-32 to stop playing a note, then restart on the same note when it receives note-on data that has the same note number as the current one.

MULTIPLE ASSIGN

This function causes the MT-32 to switch to another voice and continue playing a note when it receives note-on data that has the same note number as the current one.

PRIORITY TO LAST DATA [First in, First out]

If the new note-on messages exceed the number of notes played simultaneously, the MT-32 will stop playing notes one after another in the order in which it started playing them.

PRIORITY TO FIRST DATA [First in, Last out]

If the new note-on messages exceed the number of notes played simultaneously, the MT-32 will stop playing notes one after another in the order opposite to that in which it started playing them.

3) WRITING USER PATCHES TO MEMORY

The MT-32 allows a System Exclusive patch to replace any of the 128 built-in patches.

4) TIMBRE CONTROL

This function allows the user to compile and edit timbre data.

COMMON PARAMETER	ADJUSTABLE RANGE
Name	Alphanumerics and symbols
Structure 1, 2 (3, 4)	1 to 13
Partial Mute	OFF, ON
ENV Mode	Normal, NO Sustain

PARTIAL PARAMETER		ADJUSTABLE RANGE
WG Pitch	Coarse	C1, C#1 ... C9
	Fine	-50 ... 0 ... +50
	Keyfollow	-1, -1/2, -1/4, 0, 1/8, 1/4, 3/8, 1/2, 5/8, 3/4, 7/8, 1, 5/4, 3/2, 2 s1, s2
	Bender Switch	Off/On
WG	Waveform	Square/Sawtooth
	PCM Wave No.	1 ... 128
	Pulse Width	0 ... 100
	PW Velocity Sense	-7 ... 0 ... +7
P-ENV	Depth	0 ... 10
	Velocity Sens	0 ... 100
	Time Keyfollow	0 ... 4
	Time 1/2/3/4	0 ... 100
	Level 0/1/2	-50 ... 0 ... +50
	Sustain level	-50 ... 0 ... +50
	End level	-50 ... 0 ... +50
P-LFO	Rate	0 ... 100
	Depth	0 ... 100
	Modulation Sense	0 ... 100
TVF	Cutoff Frequency	0 ... 100
	Resonance	0 ... 30
	Keyfollow	-1, -1/2, -1/4, 0, 1/8, 1/4, 3/8, 1/2, 5/8, 3/4, 7/8, 1, 5/4, 3/2, 2
	Bias Point/Direction	<A1...<C7, >A1...>C7
	Bias Level	-7 ... 0 ... +7
TVF ENV	Depth	0 ... 100
	Velocity Sense	0 ... 100
	Depth Keyfollow	0 ... 4
	Time keyfollow	0 ... 4
	Time 1/2/3/4/5	0 ... 100
	Level 1/2/3	0 ... 100
	Sustain Level	0 ... 100
TVA	Level	0 ... 100
	Velocity Sense	-50 ... 0 ... +50
	Bias Point 1/2	<A1...<C7, >A1...>C7
	Bias level 1/2	-12 ... 0
TVA ENV	Time Keyfollow	0 ... 4
	Time 1 Velocity Follow	0 ... 4
	Time 1/2/3/4/5	0 ... 100
	Level 1/2/3	0 ... 100
	Sustain Level	0 ... 100

5) WRITING TIMBRE DATA TO MEMORY

The MT-32 is capable of storing up to 64 different timbres at memory locations that are not used by the built-in timbres.

6) RHYTHM PART CONTROL

Any key number between 24 and 87 is accessible to the user for the following functions:

FUNCTION	DESCRIPTION	ADJUSTABLE RANGE
Timbre	Selects the timbre.	R: 01 to 30 I: 01 to 64
Output level	Adjust the output volume.	0 to 100
Pan-pot	Adjust the stereo balance.	15-steps between L and R
Reverb switch	Turns the reverb effect on and off	ON or OFF

7) DATA TRANSFER

The MT-32 allows bulk dump or load of all memory-resident data.

*The MT-32 does not allow bulk dump (data transfer) unless it receives a request-to-send message from a remote instrument. Therefore, data transfer is not possible between MT-32 units.

ROM PLAY

The MT-32 stores five songs for demonstrating the excellent quality of "LA" sound source and the effect of the Multi Timbral function. Playing those pre-programmed songs is called "ROM Play" in this manual.

PROCEDURE

- (1) While holding the Master Volume button (1), switch on the unit, then select a song (1 – 5) using the Part button (2) numbered 1 to 5.

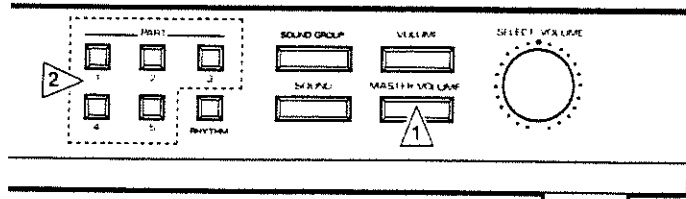

- (2) Press the Volume button (3) to play the selected song. (See the picture below.)

- To stop playing, press the Sound Group button (4).
- To play 1 to 5 songs repeatedly, press the Sound button (5), then the Volume button (3).

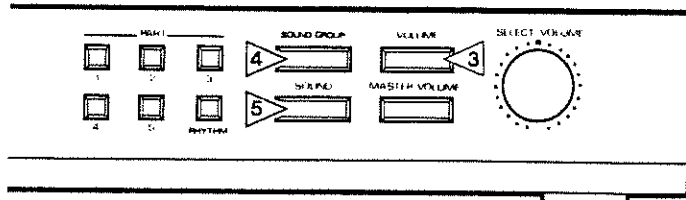

- (3) To leave the ROM Play mode, switch the unit off, then switch it on again.

*The performance data of the ROM Play is not output from the MIDI OUT connector.

*During ROM Play, no MIDI message is received from the MIDI IN connector.

Song Number	Song Name	
1	Boiler Buster	Music by Adrian Scott (c) 1988 by Adrian Scott
2	Sinfonia 1	Composed by J.S. Bach
3	Adjarre	Music by Eric Persing (c) 1988 by Eric Persing
4	Short Demo	Music by Adrain Scott (c) 1988 by Adrian Scott
5	Good Morning	Music by Phill Curry (c) 1987 by Phill Curry Music

MAJOR SPECIFICATIONS

MT-32 Multi-timbre Sound Module

<p>Sound source: LA [Linear Arithmetic synthesis]</p> <p>Number of notes: Up to 32 simultaneously</p> <p>Number of timbres: Up to 8 and one Rhythm Part simultaneously</p> <p>Preset timbres: 128 for Sound Parts and 30 for Rhythm Part</p> <p>Control panel buttons: PART buttons 1 through 5 and one RHYTHM button (Parts 6 to 8 also accessible) SOUND GROUP button SOUND button VOLUME button MASTER VOLUME button SELECT/VOLUME control</p> <p>Display: 20-character backlit liquid crystal display</p> <p>Connectors: OUTPUT jacks — L (mono) and R HEADPHONE jack MIDI connectors — IN, OUT, and THRU DC IN jack</p>	<p>Power supply: 9V DC (supplied by ACB-Series AC adapter)</p> <p>Current consumption: 650 mA (at 9V DC)</p> <p>External dimensions: 305 mm (width) x 220 mm (depth) x 45 mm (height) 12" x 8-½" x 1-¾" (except for the protruding sections)</p> <p>Weight: 1.5 kg/3 lb 5 oz</p> <p>ACCESSORIES (Supplied): AC adapter (ACB-Series) MIDI cable (1 pc.) Connecting cord (2 pcs.) Owner's Manual "Sound List" "What Is MIDI"</p>
---	---

*The specifications of this product are subject to change without prior notice for improvement.

The default settings of MT-32 (when the power is on)

Part	Sound Group	Sound	Partial	Partial Reserve	Pan	MIDI Ch
1	Bass	Slap Bass 1	(3)	3	><	2
2	Strings	Str Sect 1	(4)	10	><	3
3	Brass	Brs Sect 1	(4)	6	><	4
4	Wind-2	Sax 1	(4)	4	><	5
5	Synth-2	Ice Rain	(3)	3	<4	6
6	Piano	Elec Piano 1	(3)	0	4>	7
7	Special	Bottle Blow	(4)	0	<7	8
8	Effects	Orche Hit	(4)	0	7>	9
Rhythm	—	—		6	—	10

For Canada

CLASS B

NOTICE

This digital apparatus does not exceed the Class B limits for radio noise emissions set out in the Radio Interference Regulations of the Canadian Department of Communications.

CLASSE B

AVIS

Cet appareil numérique ne dépasse pas les limites de la classe B au niveau des émissions de bruits radioélectriques fixés dans le Règlement des signaux parasites par le ministère canadien des Communications.

MT-32

MIDI Implementation

Roland Exclusive Messages

1. Data Format for Exclusive Messages

Roland's MIDI implementation uses the following data format for all exclusive messages (type IV):

Byte	Description
F0H	Exclusive status
41H	Manufacturer ID (Roland)
DEV	Device ID
MDL	Model ID
CMD	Command ID
[BODY]	Main data
F7H	End of exclusive

MIDI status : F0H, F7H

An exclusive message must be flanked by a pair of status codes, starting with a Manufacturer-ID immediately after F0H (MIDI version 1.0).

Manufacturer-ID : 41H

The Manufacturer-ID identifies the manufacturer of a MIDI instrument that triggers an exclusive message. Value 41H represents Roland's Manufacturer-ID.

Device-ID : DEV

The Device-ID contains a unique value that identifies the individual device in the multiple implementation of MIDI instruments. It is usually set to 00H - 0FH, a value smaller by one than that of a basic channel, but value 00H - 1FH may be used for a device with multiple basic channels.

Model-ID : MDL

The Model-ID contains a value that uniquely identifies one model from another. Different models, however, may share an identical Model-ID if they handle similar data.

The Model-ID format may contain 00H in one or more places to provide an extended data field. The following are examples of valid Model-IDs, each representing a unique model:

01H
02H
03H
00H, 01H
00H, 02H
00H, 00H, 01H

Command-ID : CMD

The Command-ID indicates the function of an exclusive message. The Command-ID format may contain 00H in one or more places to provide an extended data field. The following are examples of valid Command-IDs, each representing a unique function:

01H
02H
03H
00H, 01H
00H, 02H
00H, 00H, 01H

Main data : BODY

This field contains a message to be exchanged across an interface. The exact data size and contents will vary with the Model-ID and Command-ID.

2. Address-mapped Data Transfer

Address mapping is a technique for transferring messages conforming to the data format given in Section 1. It assigns a series of memory-resident records--waveform and tone data, switch status, and parameters, for example--to specific locations in a machine-dependent address space, thereby allowing access to data residing at the address a message specifies.

Address-mapped data transfer is therefore independent of models and data categories. This technique allows use of two different transfer procedures: one-way transfer and handshake transfer.

One-way transfer procedure (See Section 3 for details.)

This procedure is suited for the transfer of a small amount of data. It sends out an exclusive message completely independent of a receiving device status.

Connection Diagram



Connectional point 2 is essential for "Request data" procedures. (See Section 3.)

Handshake-transfer procedure (See Section 4 for details.)

This procedure initiates a predetermined transfer sequence (handshaking) across the interface before data transfer takes place. Handshaking ensures that reliability and transfer speed are high enough to handle a large amount of data.

Connection Diagram

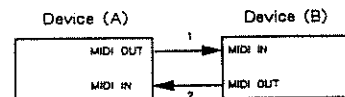

Connectional points 1 and 2 is essential.

Notes on the above two procedures

* There are separate Command-IDs for different transfer procedures.

* Devices A and B cannot exchange data unless they use the same transfer procedure, share identical Device-ID and Model ID, and are ready for communication.

3. One-way Transfer Procedure

This procedure sends out data all the way until it stops when the messages are so short that answerbacks need not be checked.

For long messages, however, the receiving device must acquire each message in time with the transfer sequence, which inserts intervals of at least 20 milliseconds in between.

Types of Messages

Message	Command ID
Request data 1	RQ1 (11H)
Data set 1	DT1 (12H)

Request data # 1 : RQ1 (11H)

This message is sent out when there is a need to acquire data from a device at the other end of the interface. It contains data for the address and size that specify designation and length, respectively, of data required.

On receiving an RQ1 message, the remote device checks its memory for the data address and size that satisfy the request.

If it finds them and is ready for communication, the device will transmit a "Data set 1 (DT1)" message, which contains the requested data. Otherwise, the device will send out nothing.

Byte	Description
F0H	Exclusive status
41H	Manufacturer ID (Roland)
DEV	Device ID
MDL	Model ID
11H	Command ID
aaH	Address MSB
⋮	⋮
⋮	LSB
ssH	Size MSB
⋮	⋮
⋮	LSB
sum	Check sum
F7H	End of exclusive

- *The size of the requested data does not indicate the number of bytes that will make up a DT1 message, but represents the address fields where the requested data resides.
- *Some models are subject to limitations in data format used for a single transaction. Requested data, for example, may have a limit in length or must be divided into predetermined address fields before it is exchanged across the interface.
- *The same number of bytes comprises address and size data, which, however, vary with the Model-ID.
- *The error checking process uses a checksum that provides a bit pattern where the least significant 7 bits are zero when values for an address, size, and that checksum are summed.

Data set 1 : DT1 (12H)

This message corresponds to the actual data transfer process. Because every byte in the data is assigned a unique address, a DT1 message can convey the starting address of one or more data as well as a series of data formatted in an address-dependent order.

The MIDI standards inhibit non-real time messages from interrupting an exclusive one. This fact is inconvenient for the devices that support a "soft-through" mechanism. To maintain compatibility with such devices, Roland has limited the DT1 to 256 bytes so that an excessively long message is sent out in separate segments.

Byte	Description
FOH	Exclusive
41H	Manufacturer ID (Roland)
DEV	Device ID
MDL	Model ID
12H	Command ID
aaH	Address MSB
⋮	⋮
	LSB
ddH	Data
⋮	⋮
sum	Check sum
F7H	End of exclusive

- *A DT1 message is capable of providing only the valid data among those specified by an RQ1 message.
- *Some models are subject to limitations in data format used for a single transaction. Requested data, for example, may have a limit in length or must be divided into predetermined address fields before it is exchanged across the interface.
- *The number of bytes comprising address data varies from one Model-ID to another.
- *The error checking process uses a checksum that provides a bit pattern where the least significant 7 bits are zero when values for an address, size, and that checksum are summed.

Example of Message Transactions

- Device A sending data to Device B
Transfer of a DT1 message is all that takes place.

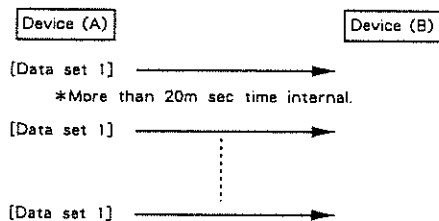

- Device B requesting data from Device A
Device B sends an RQ1 message to Device A. Checking the message, Device A sends a DT1 message back to Device B.

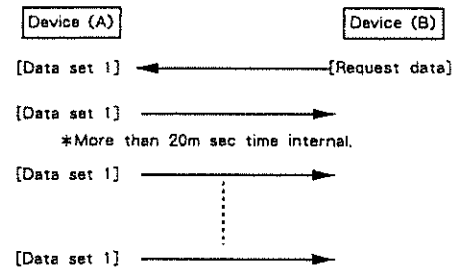

4. Handshake-Transfer Procedure

Handshaking is an interactive process where two devices exchange error checking signals before a message transaction takes place, thereby increasing data reliability. Unlike one-way transfer that inserts a pause between message transactions, handshake transfer allows much speedier transactions because data transfer starts once the receiving device returns a ready signal.

When it comes to handling large amounts of data--sampler waveforms and synthesizer tones over the entire range, for example--across a MIDI interface, handshaking transfer is more efficient than one-way transfer.

Types of Messages

Message	Command ID
Want to send data	WSD (40H)
Request data	RQD (41H)
Data set	DAT (42H)
Acknowledge	ACK (43H)
End of data	EOD (45H)
Communication error	ERR (4EH)
Rejection	RJC (4FH)

Want to send data : WSD (40H)

This message is sent out when data must be sent to a device at the other end of the interface. It contains data for the address and size that specify designation and length, respectively, of the data to be sent.

On receiving a WSD message, the remote device checks its memory for the specified data address and size which will satisfy the request. If it finds them and is ready for communication, the device will return an "Acknowledge (ACK)" message. Otherwise, it will return a "Rejection (RJC)" message.

Byte	Description
FOH	Exclusive status
41H	Manufacturer ID (Roland)
DEV	Device ID
MDL	Model ID
40H	Command ID
aaH	Address MSB
⋮	⋮
	LSB
ssH	Size MSB
⋮	⋮
	LSB
sum	Check sum
F7H	End of exclusive

- *The size of the data to be sent does not indicate the number of bytes that make up a "Data set (DAT)" message, but represents the address fields where the data should reside.
- *Some models are subject to limitations in data format used for a single transaction. Requested data, for example, may have a limit in length or must be divided into predetermined address fields before it is exchanged across the interface.
- *The same number of bytes comprises address and size data, which, however, vary with the Model-ID.
- *The error checking process uses a checksum that provides a bit pattern where the least significant 7 bits are zero when values for an address, size, and that checksum are summed.

Request data : RQD (41H)

This message is sent out when there is a need to acquire data from a device at the other end of the interface. It contains data for the address and size that specify designation and length, respectively, of data required.

On receiving an RQD message, the remote device checks its memory for the data address and size which satisfy the request. If it finds them and is ready for communication, the device will transmit a "Data set (DAT)" message, which contains the requested data. Otherwise, it will return a "Rejection (RJC)" message.

Byte	Description
F0H	Exclusive status
41H	Manufacturer ID (Roland)
DEV	Device ID
MDL	Model ID
41H	Command ID
aaH	Address MSB
⋮	⋮
	LSB
ssH	Size MSB
⋮	⋮
	LSB
sum	Check sum
F7H	End of exclusive

- *The size of the requested data does not indicate the number of bytes that make up a "Data set (DAT)" message, but represents the address fields where the requested data resides.
- *Some models are subject to limitations in data format used for a single transaction. Requested data, for example, may have a limit in length or must be divided into predetermined address fields before it is exchanged across the interface.
- *The same number of bytes comprises address and size data, which, however, vary with the Model-ID.
- *The error checking process uses a checksum that provides a bit pattern where the least significant 7 bits are zero when values for an address, size, and that checksum are summed.

Data set : DAT (42H)

This message corresponds to the actual data transfer process. Because every byte in the data is assigned a unique address, the message can convey the starting address of one or more data as well as a series of data formatted in an address-dependent order.

Although the MIDI standards inhibit non-real time messages from interrupting an exclusive one, some devices support a "soft-through" mechanism for such interrupts. To maintain compatibility with such devices, Roland has limited the DAT to 256bytes so that an excessively long message is sent out in separate segments.

Byte	Description
F0H	Exclusive status
41H	Manufacturer ID (Roland)
DEV	Device ID
MDL	Model ID
42H	Command ID
aaH	Address MSB
⋮	⋮
	LSB
ddH	Data
⋮	⋮
sum	Check sum
F7H	End of exclusive

- *A DAT message is capable of providing only the valid data among those specified by an RQD or WSD message.
- *Some models are subject to limitations in data format used for a single transaction. Requested data, for example, may have a limit in length or must be divided into predetermined address fields before it is exchanged across the interface.
- *The number of bytes comprising address data varies from one model ID to another.
- *The error checking process uses a checksum that provides a bit pattern where the least significant 7 bits are zero when values for an address, size, and that checksum are summed.

Acknowledge : ACK (43H)

This message is sent out when no error was detected on reception of a WSD, DAT, "End of data (EOD)", or some other message and a requested setup or action is complete. Unless it receives an ACK message, the device at the other end will not proceed to the next operation.

Byte	Description
F0H	Exclusive status
41H	Manufacturer ID (Roland)
DEV	Device ID
MDL	Model ID
43H	Command ID
F7H	End of exclusive

End of data : EOD (45H)

This message is sent out to inform a remote device of the end of a message. Communication, however, will not come to an end unless the remote device returns an ACK message even though an EOD message was transmitted.

Byte	Description
F0H	Exclusive status
41H	Manufacturer ID (Roland)
DEV	Device ID
MDL	Model ID
45H	Command ID
F7H	End of exclusive

Communications error : ERR (4EH)

This message warns the remote device of a communications fault encountered during message transmission due, for example, to a checksum error. An ERR message may be replaced with a "Rejection (RJC)" one, which terminates the current message transaction in midstream.

When it receives an ERR message, the sending device may either attempt to send out the last message a second time or terminate communication by sending out an RJC message.

Byte	Description
F0H	Exclusive status
41H	Manufacturer ID (Roland)
DEV	Device ID
MDL	Model ID
4EH	Command ID
F7H	End of exclusive

Rejection : RJC (4FH)

This message is sent out when there is a need to terminate communication by overriding the current message. An RJC message will be triggered when :

- a WSD or RQD message has specified an illegal data address or size, or the device is not ready for communication.
- an illegal number of addresses or data has been detected.
- data transfer has been terminated by an operator.
- a communications error has occurred.

An ERR message may be sent out by a device on either side of the interface. Communication must be terminated immediately when either side triggers an ERR message.

Byte	Description
F0H	Exclusive status
41H	Manufactures ID (Roland)
DEV	Device ID
MDL	Model ID
4FH	Command ID
F7H	End of exclusive

Example of Message Transactions

● Data transfer from device (A) to device (B).

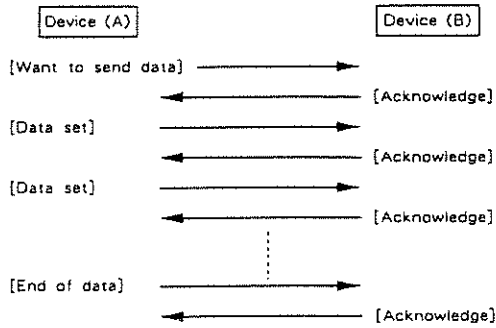

● Device (A) requests and receives data from device (B).

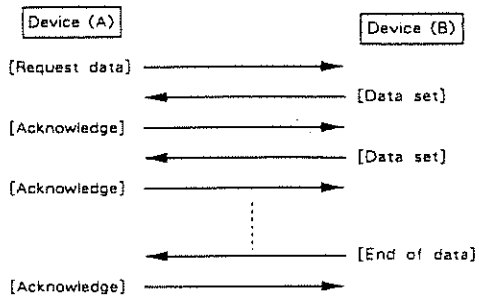

● Error occurs while device (A) is receiving data from device (B).

1) Data transfer from device (A) to device (B).

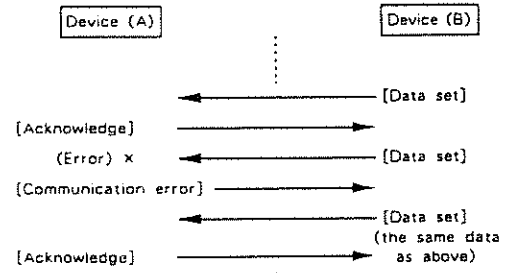

2) Device (B) rejects the data re-transmitted, and completes data transfer.

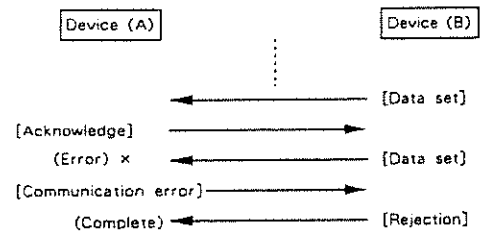

3) Device (A) immediately completes data transfer.

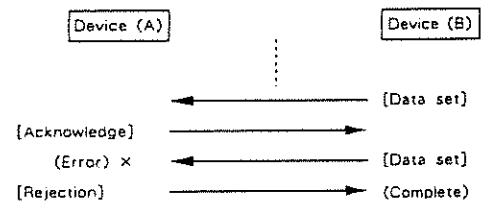

1. TRANSMITTED DATA

■ Bypassed message

In Overflow Assign mode, retransmits the following MIDI IN messages from MIDI OUT.

- All channel voice messages except Note On.
- Note on message (s) to which MT - 32 cannot assign voice (s) because the number of received Note on messages exceeds MT - 32's simultaneously assignable voices.
- System Exclusive message whose manufacturer ID# is 41H.

■ Exclusive

Status

F0H : System exclusive
F7H : EOX (End Of Exclusive)

For details, see Sections 4 and 5, and Roland Exclusive Messages.

2. RECOGNIZED RECEIVE DATA (Parts 1 - 8)

■ Note event

● Note off

<u>Status</u>	<u>Second</u>	<u>Third</u>
8nH	kkH	vvH
9nH	kkH	00H

kk = note number 00H - 7FH (0 - 127)
vv = velocity ignored
n = MIDI Channel 0H - FH (1 - 16)

A tone whose envelope mode is "NO SUS" ignores Note off message.

● Note on

<u>Status</u>	<u>Second</u>	<u>Third</u>
9nH	kkH	vvH

kk = note number 00H - 7FH (0 - 127)
vv = velocity 01H - 7FH (1 - 127)
n = MIDI Channel 0H - FH (1 - 16)

Note numbers outside of the range 12 - 108 are transposed to the nearest octave inside the range.

■ Control change

● Modulation Depth

<u>Status</u>	<u>Second</u>	<u>Third</u>
BnH	01H	vvH

vv = Modulation depth 00H - 7FH (0 - 127)
n = MIDI Channel 0H - FH (1 - 16)

● Data Entry

<u>Status</u>	<u>Second</u>	<u>Third</u>
BnH	06H	vvH

vv = Value of a parameter specified by RPC. (See description in RPC MSB.)
n = MIDI Channel 0H - FH (1 - 16)

● Main Volume

<u>Status</u>	<u>Second</u>	<u>Third</u>
BnH	07H	vvH

vv = Volume Value 00H - 7FH (0 - 127)
n = MIDI Channel 0H - FH (1 - 16)

Controls the volume of a Part accessible through the received MIDI channel. The maximum volume is determined by Master volume and Expression message.

● Panpot

<u>Status</u>	<u>Second</u>	<u>Third</u>
BnH	0AH	vvH

vv = Panpot Value 00H - 7FH (0 - 127)
n = MIDI Channel 0H - FH (1 - 16)

Orientation of sound is as follows.

127 = LEFT, 63 = CENTER, 0 = RIGHT

● Expression

<u>Status</u>	<u>Second</u>	<u>Third</u>
BnH	0BH	vvH

vv = Expression 00H - 7FH (0 - 127)
n = MIDI Channel 0H - FH (1 - 16)

Controls the volume of a Part accessible through the received MIDI channel. The maximum volume is determined by Master volume and Main Volume message.

● Hold - 1

<u>Status</u>	<u>Second</u>	<u>Third</u>
BnH	40H	vvH

vv = 00H - 3FH : off
vv = 40H - 7FH : on
n = MIDI Channel 0H - FH (1 - 16)

● RPC LSB

<u>Status</u>	<u>Second</u>	<u>Third</u>
BnH	64H	vvH

vv = The lower byte of a parameter number controlled by RPC. (Refer to RPC MSB.)
n = MIDI Channel 0H - FH (1 - 16)

● RPC MSB

<u>Status</u>	<u>Second</u>	<u>Third</u>
BnH	65H	vvH

vv = The upper byte of a parameter number controlled by RPC.
n = MIDI Channel 0H - FH (1 - 16)

Using MIDI RPC, MT - 32 parameters can be controlled by Control change message. RPC MSB and LSB specify the parameter to be controlled while Data entry sets the parameter value. Effective RPC to MT - 32 is Bender range.

RPC	Data Entry	Description
MSB	LSB	
00H	00H vvH	Bender Range vv = 0 - 24 Unit in semitone, 2 octaves maximum

● Resets All Controllers

<u>Status</u>	<u>Second</u>	<u>Third</u>
BnH	79H	00H

n = MIDI Channel 0H - FH (1 - 16)

Sets each of the following controls as follows.

Controller	setting
Modulation Depth	OFF (0)
Expression	MAX (127)
Hold 1	OFF (0)
Pitch Bender Change	CENTER

■ Program change

● Patch Change

Status	Second
CnH	ppH

pp = Patch Number 0H - 7FH (0 - 127)
 n = MIDI Channel 0H - FH (1 - 16)

Program change information is used to change Patches.

■ Pitch Bender change

● Pitch Bender

Status	Second	Third
EnH	llH	mmH

ll = Pitch Bender change value (Lower byte)
 00H - 7FH (0 - 127)
 mm = Pitch Bender change value (Upper byte)
 00H - 7FH (0 - 127)
 n = MIDI Channel 0H - FH (1 - 16)

■ Mode message

● All notes off

Status	Second	Third
BnH	7BH	00H

n = MIDI Channel 0H - FH (1 - 16)

Turns off all notes that have been turned on by MIDI Note on.

● OMNI OFF

Status	Second	Third
BnH	7CH	00H

n = MIDI Channel 0H - FH (1 - 16)

Recognized as only All notes off.
 MT - 32 remains in mode 3 (omni off, poly).

● OMNI ON

Status	Second	Third
BnH	7DH	00H

n = MIDI Channel 0H - FH (1 - 16)

Recognized as only All notes off.
 MT - 32 remains in mode 3 (omni off, poly).

● MONO

Status	Second	Third
BnH	7EH	00H

n = MIDI Channel 0H - FH (1 - 16)

Recognized as only All notes off.
 MT - 32 remains in mode 3 (omni off, poly).

● POLY

Status	Second	Third
BnH	7FH	00H

n = MIDI Channel 0H - FH (1 - 16)

Recognized as only All notes off.
 MT - 32 remains in mode 3 (omni off, poly).

■ Exclusive

Status

FOH : System Exclusive
 F7H : EOX (End Of Exclusive)

Using exclusive message, a set of parameters for a timbre or individual parameter in a patch or timbre can be transferred to MT - 32.
 Refer to Roland Exclusive Messages and Sections 4 and 5.

■ Active sensing

Status

FEH : Active Sensing

Having received this message, MT - 32 expects to receive information of any status or data every 300ms (max). If MT - 32 fails to sense message, it assumes that MIDI bus is disconnected for some reason. Then MT - 32 turns off all notes which have been turned on by MIDI and returns to normal operation (will not check intervals of messages).

3. RECOGNIZED RECEIVE DATA (Rhythm Part)

Messages on MIDI channels not assigned to rhythm part are ignored.

■ Note event

● Note off

Status	Second	Third
8nH	kkH	vvH
9nH	kkH	00H

kk = note number 18H - 57H (24 - 87)
 vv = velocity ignored
 n = MIDI Channel 0H - FH (1 - 16)

A tone whose envelope mode is "NO SUS" ignores Note off message.

● Note on

Status	Second	Third
9nH	kkH	vvH

kk = note number 18H - 57H (24 - 87)
 vv = velocity 01H - 7FH (1 - 127)
 n = MIDI Channel 0H - FH (1 - 16)

Note numbers outside of the range 24 - 87 are ignored.

■ Control change

● Modulation Depth

Status	Second	Third
BnH	01H	vvH

vv = Modulation depth 00H - 7FH (0 - 127)
 n = MIDI Channel 0H - FH (1 - 16)

● Data Entry

Status	Second	Third
BnH	06H	vvH

vv = Value of a parameter specified by RPC. (See description in RPC MSB.)
 n = MIDI Channel 0H - FH (1 - 16)

● Main Volume

Status	Second	Third
BnH	07H	vvH
vv = Volume Value	00H - 7FH (0 - 127)	
n = MIDI Channel	0H - FH (1 - 16)	

Can control the volume of the rhythm part.
The maximum volume is determined by Master volume and Expression message.

● Expression

Status	Second	Third
BnH	0BH	vvH
vv = Expression	00H - 7FH (0 - 127)	
n = MIDI Channel	0H - FH (1 - 16)	

Controls the volume of a Part accessible through the received MIDI channel. The maximum volume is determined by Master volume and Main Volume message.

● Hold - 1

Status	Second	Third
BnH	40H	vvH
vv = 00H - 3FH : off		
vv = 40H - 7FH : on		
n = MIDI Channel	0H - FH (1 - 16)	

● RPC LSB

Status	Second	Third
BnH	64H	vvH
vv = The lower byte of a parameter number controlled by RPC. (Refer to RPC MSB.)		
n = MIDI Channel	0H - FH (1 - 16)	

● RPC MSB

Status	Second	Third
BnH	65H	vvH
vv = The upper byte of a parameter number controlled by RPC.		
n = MIDI Channel	0H - FH (1 - 16)	

MSB and LSB RPC together specifies parameter to be controlled while Data entry determines the value.
Effective RPC on MT-32 is Bender range.

RPC	Data Entry	Description
MSB	LSB	
00H	00H vvH	Bender Range vv = 0 - 24 Unit in semitone, 2 octaves maximum

● Resets All Controllers

Status	Second	Third
BnH	79H	00H
n = MIDI Channel	0H - FH (1 - 16)	

Sets controllers to the value as shown below.

Controller	setting	
Modulation Depth	OFF	(0)
Expression	MAX	(127)
Hold 1	OFF	(0)
Pitch Bender Change	CENTER	

■ Pitch Bender change

● Pitch Bender

Status	Second	Third
EnH	11H	mmH
ll = Pitch Bender change value (Lower byte)	00H - 7FH (0 - 127)	
mm = Pitch Bender change value (Upper byte)	00H - 7FH (0 - 127)	
n = MIDI Channel	0H - FH (1 - 16)	

■ Exclusive

Status
F0H : System Exclusive
F7H : EOX (End Of Exclusive)

Using exclusive message, a set of parameters for a individual parameters in a rhythm part can be transferred to MT-32.
Refer to Roland Exclusive Messages and Sections 4 and 5.

4.EXCLUSIVE COMMUNICATION

Parameters for patches or timbres can be transferred to/from MT-32 through Exclusive message.

Model-ID# of MT-32 is 16H.

In a system where more than one MIDI channel is assigned to MT-32, Unit # may be set to the MT-32 instead of Device-ID# of a basic channel. The advantage of Unit # is that a specific part is made accessible independent of MIDI channel of that part.

Whether to use MIDI channel or Unit # depends on parameter address.

MT-32 recognizes MIDI channels 1 thru 16 and Unit # 1 thru 32 as Device-ID #. Note that the actual Device-ID # is the number 1 less MIDI channel number or Unit #.

■ One way communication

Request Data 1 RQ1 11H

Byte	Description
F0H	Exclusive status
41H	Manufacturer's ID (Roland)
DEV	Device ID
16H	Model ID
11H	Command ID (RQ1)
aaH	Address MSB * 4-1
aaH	Address
aaH	Address LSB
ssH	Size MSB
ssH	Size
ssH	Size LSB
sum	Check sum
F7H	EOX (End Of Exclusive)

Data set 1 DT1 12H

Byte	Description
F0H	Exclusive status
41H	Manufacturer's ID (Roland)
DEV	Device ID
16H	Model ID
12H	Command ID (DT1)
aaH	Address MSB * 4-1
aaH	Address
aaH	Address LSB
ddH	Data * 4-2
:	:
sum	Check sum
F7H	EOX (End Of Exclusive)

MT-32 will never require any data of the other party. The following sequence can apply to the outside world where a unit wants to get MT-32 resident parameters.

```

Receiver                               Transmitter(MT-32)
-----                               -----

                                [RQD]----->

(                                     )
(Ends current communication upon      Will send this message when )
(receipt of this message.            Data request comes while it )
(                                     is reproducing sound.         )

```

```

<-----[DAT]
When the Data request comes
during no-sound period and
contains address listed in the
Parameter base address table
followed by 1 or more address
size, MT-32 will send the data
stored in that address area
and subsequent.

```

If the address matches the parameter base address, stores the data into that location; then sends Acknowledge.

```

[ACK]----->
Sends the next data in reply
to Acknowledge.

<-----[DAT]
[ACK]----->
:
( [ERR]-----> )
(should failure in data reception When receiving this message, )
(occur(e.g. disagreement of checksum), sends the previous data )
(sends this message. again. )
( <-----[DAT] )
:
:
<-----[EOD]

```

sends Acknowledge in response to Data end and terminates handshaking communication. Sends this data when completing required data transfer.

```

[ACK]----->
When this message comes as an
answer to the Data end,
terminates communication.

```

*4-1 Address and Address size must cover the memory location where data exist.

*4-2 When coming data are for partial reserve of the system parameter, MT-32 will make these reserves effective only after receiving all the data.

5. PARAMETER ADDRESS MAP

Addresses are represented in 7-bit hexadecimal.

```

Address | MSB | | | LSB
-----+-----+-----
Binary  | 0aaa aaaa | 0bbb bbbb | 0ccc cccc
7-bit Hexadecimal | AA | BB | CC

```

The actual address of a parameter is a sum of the start address of each block and one or more offset address.

- *5-1 Start address plus two offset addresses
(in tables *5-1 and *5-1-1 (*5-1-2))
- *5-2 Start address plus one offset address
(in tables *5-2)
- *5-3 Start address plus two offset addresses
(in tables *5-3 and *5-3-1)
- *5-4 - *5-7 Start address plus one offset address
(in tables *5-4 - *5-7)

Parameter base address

Temporary area (Accessed through each basic channel)

Start address	Description	
02 00 00	Timbre Temporary Area (part 1 - 8)	*5-1

Whole part (Accessible on UNIT #)

Start address	Description	
03 00 00	Patch Temporary Area (part 1)	*5-2
03 00 10	Patch Temporary Area (part 2)	
:	:	
03 00 60	Patch Temporary Area (part 7)	
03 00 70	Patch Temporary Area (part 8)	
03 01 00	Patch Temporary Area (rhythm part)	
03 01 10	Rhythm Setup Temporary Area	*5-3
04 00 00	Timbre Temporary Area (part 1)	*5-1
04 01 76	Timbre Temporary Area (part 2)	
:	:	
04 08 44	Timbre Temporary Area (part 7)	
04 0D 3A	Timbre Temporary Area (part 8)	
05 00 00	Patch Memory #1	*5-4
05 00 08	Patch Memory #2	
:	:	
05 07 70	Patch Memory #127	
05 07 78	Patch Memory #128	
08 00 00	Timbre Memory #1	*5-1
08 02 00	Timbre Memory #2	
:	:	
08 7C 00	Timbre Memory #63	
08 7E 00	Timbre Memory #64	
10 00 00	System area	*5-5
20 00 00	Display	*5-6
40 00 00	Write Request	*5-7
7F x x x	All parameters Reset	*5-8

Notes :

*5-1 Timbre Temporary area / Timbre Memory

Offset address	Description	
00 00 00	Common parameter	*5-1-1
00 00 0E	Partial parameter (for Partial# 1)	*5-1-2
00 00 48	Partial parameter (for Partial# 2)	
00 01 02	Partial parameter (for Partial# 3)	
00 01 3C	Partial parameter (for Partial# 4)	

MT-32 never requests data of the other party.
 The following sequence applies to the other party that wants to get some parameters from MT-32.

Receiver -----	Transmitter(MT-32) -----
	[RQ1]----->
When a programmer or sequencer needs MT-32 resident parameter.	When the received Data request contains 1) address that matches a parameter base address and 2) address size is 1 or more, MT-32 sends the data in that area.

<-----[DT1]

If the address matches the parameter base address, stores the data into that location.

```
(
  (
    (
      (
        <-----[DT1]
      )
    )
  )
  Will repeat sending Data set )
  until all requested data are )
  received by the receiver. )
```

■ Handshaking communication

Want to send data WSD 40H

Byte	Description
F0H	Exclusive status
41H	Manufacturer's ID (Roland)
DEV	Device ID
16H	Model ID
40H	Command ID (WSD)
aaH	Address MSB * 4-1
aaH	Address
aaH	Address LSB
ssH	Size MSB
ssH	Size
ssH	Size LSB
sum	Check sum
F7H	EOX (End Of Exclusive)

Request data RQD 41H

Byte	Description
F0H	Exclusive status
41H	Manufacturer's ID (Roland)
DEV	Device ID
16H	Model ID
41H	Command ID (RQD)
aaH	Address MSB *4-1
aaH	Address
aaH	Address LSB
ssH	Size MSB
ssH	Size
ssH	Size LSB
sum	Check sum
F7H	EOX (End Of Exclusive)

Byte	Description
F0H	Exclusive status
41H	Manufacturer's ID (Roland)
DEV	Device ID
16H	Model ID
42H	Command ID (DAT)
aaH	Address MSB *4-1
aaH	Address
aaH	Address LSB
ddH	Data *4-2
:	:
sum	Check sum
F7H	EOX (End Of Exclusive)

Acknowledge ACK 43H

Byte	Description
F0H	Exclusive status
41H	Manufacturer's ID (Roland)
DEV	Device ID
16H	Model ID
43H	Command ID (ACK)
F7H	EOX (End Of Exclusive)

End of data EOD 45H

Byte	Description
F0H	Exclusive status
41H	Manufacturer's ID (Roland)
DEV	Device ID
16H	Model ID
45H	Command ID (EOD)
F7H	EOX (End Of Exclusive)

Communication error ERR 4EH

Byte	Description
F0H	Exclusive status
41H	Manufacturer's ID (Roland)
DEV	Device ID
16H	Model ID
4EH	Command ID (ERR)
F7H	EOX (End Of Exclusive)

Rejection RJC 4FH

Byte	Description
F0H	Exclusive status
41H	Manufacturer's ID (Roland)
DEV	Device ID
16H	Model ID
4FH	Command ID (RJC)
F7H	EOX (End Of Exclusive)

*5-1-1 Common Parameter

Offset address	Description
00	0aaa aaaa TIMBRE NAME 1 32 - 127 (ASCII)
09	0aaa aaaa TIMBRE NAME 10
0A	0000 aaaa Structure of Partial# 1 & 2 0 - 12 (1 - 13)
0B	0000 aaaa Structure of Partial# 3 & 4 0 - 12 (1 - 13)
0C	0000 aaaa PARTIAL MUTE 0 - 15 (0000 - 1111)
0D	0000 000a ENV MODE 0 - 1 (Normal, No sustain)
Total size 00 00 0E	

*5-1-2 Partial Parameter

Offset address	Description
00 00	0aaa aaaa WG PITCH COARSE 0 - 96 (C1, C#1, - C9)
00 01	0aaa aaaa WG PITCH FINE 0 - 100 (-50 - +50)
00 02	0000 aaaa WG PITCH KEYFOLLOW 0 - 16 (-1, -1/2, -1/4, 0, 1/8, 1/4, 3/8, 1/2, 5/8, 3/4, 7/8, 1, 5/4, 3/2, 2, s1, s2)
00 03	0000 000a WG PITCH BENDER SW 0 - 1 (OFF, ON)
00 04	0000 000a WG WAVEFORM 0 - 1 (SQW, SAW)
00 05	0aaa aaaa WG PCM WAVE # 0 - 127 (1 - 128)
00 06	0aaa aaaa WG PULSE WIDTH 0 - 100
00 07	0000 aaaa WG PW VELO SENS 0 - 14 (-7 - +7)
00 08	0000 aaaa P-ENV DEPTH 0 - 10
00 09	0aaa aaaa P-ENV VELO SENS 0 - 100
00 0A	0000 0aaa P-ENV TIME KEYF 0 - 4
00 0B	0aaa aaaa P-ENV TIME 1 0 - 100
00 0C	0aaa aaaa P-ENV TIME 2 0 - 100
00 0D	0aaa aaaa P-ENV TIME 3 0 - 100
00 0E	0aaa aaaa P-ENV TIME 4 0 - 100
00 0F	0aaa aaaa P-ENV LEVEL 0 0 - 100 (-50 - +50)
00 10	0aaa aaaa P-ENV LEVEL 1 0 - 100 (-50 - +50)
00 11	0aaa aaaa P-ENV LEVEL 2 0 - 100 (-50 - +50)
00 12	0xxx xxxx P-ENV SUSTAIN LEVEL 0 - 100 (-50 - +50)
00 13	0aaa aaaa END LEVEL 0 - 100 (-50 - +50)
00 14	0aaa aaaa P-LFO RATE 0 - 100
00 15	0aaa aaaa P-LFO DEPTH 0 - 100
00 16	0aaa aaaa P-LFO MOD SENS 0 - 100
00 17	0aaa aaaa TVF CUTOFF FREQ 0 - 100
00 18	000a aaaa TVF RESONANCE 0 - 30
00 19	0000 aaaa TVF KEYFOLLOW 0 - 14 (-1, -1/2, -1/4, 0, 1/8, 1/4, 3/8, 1/2, 5/8, 3/4, 7/8, 1, 5/4, 3/2, 2)
00 1A	0aaa aaaa TVF BIAS POINT/DIR 0 - 127 (<1A - <7C >1A - >7C)
00 1B	0000 aaaa TVF BIAS LEVEL 0 - 14 (-7 - +7)

00 1C	0aaa aaaa	TVF ENV DEPTH	0 - 100
00 1D	0aaa aaaa	TVF ENV VELO SENS	0 - 100
00 1E	0000 0aaa	TVF ENV DEPTH KEYF	0 - 4
00 1F	0000 0aaa	TVF ENV TIME KEYF	0 - 4
00 20	0aaa aaaa	TVF ENV TIME 1	0 - 100
00 21	0aaa aaaa	TVF ENV TIME 2	0 - 100
00 22	0aaa aaaa	TVF ENV TIME 3	0 - 100
00 23	0aaa aaaa	TVF ENV TIME 4	0 - 100
00 24	0aaa aaaa	TVF ENV TIME 5	0 - 100
00 25	0aaa aaaa	TVF ENV LEVEL 1	0 - 100
00 26	0aaa aaaa	TVF ENV LEVEL 2	0 - 100
00 27	0aaa aaaa	TVF ENV LEVEL 3	0 - 100
00 28	0aaa aaaa	TVF ENV SUSTAIN LEVEL	0 - 100
00 29	0aaa aaaa	TVA LEVEL	0 - 100
00 2A	0aaa aaaa	TVA VELO SENS	0 - 100 (-50 - +50)
00 2B	0aaa aaaa	TVA BIAS POINT 1	0 - 127 (<1A - <7C >1A - >7C)
00 2C	0000 aaaa	TVA BIAS LEVEL 1	0 - 12 (-12 - 0)
00 2D	0aaa aaaa	TVA BIAS POINT 2	0 - 127 (<1A - <7C >1A - >7C)
00 2E	0000 aaaa	TVA BIAS LEVEL 2	0 - 12 (-12 - 0)
00 2F	0000 0aaa	TVA ENV TIME KEYF	0 - 4
00 30	0000 0aaa	TVA ENV TIME V_FOLLOW	0 - 4
00 31	0aaa aaaa	TVA ENV TIME 1	0 - 100
00 32	0aaa aaaa	TVA ENV TIME 2	0 - 100
00 33	0aaa aaaa	TVA ENV TIME 3	0 - 100
00 34	0aaa aaaa	TVA ENV TIME 4	0 - 100
00 35	0aaa aaaa	TVA ENV TIME 5	0 - 100
00 36	0aaa aaaa	TVA ENV LEVEL 1	0 - 100
00 37	0aaa aaaa	TVA ENV LEVEL 2	0 - 100
00 38	0aaa aaaa	TVA ENV LEVEL 3	0 - 100
00 39	0aaa aaaa	TVA ENV SUSTAIN LEVEL	0 - 100
Total size		00 00 3A	

Example of RQ1 and DT1 application --- 1

Assuming that MT-32 sets Unit # to 17, obtain Part 2 tone data from the temporary area by sending the following messages.

FO 41 10 16 11 04 01 76 00 01 76 0E F7

*5-2 Patch temporary area

Offset address	Description		
00 00	0000 0aaa TIMBRE GROUP 0 - 3 (a, b, i, r)		
00 01	00aa aaaa TIMBRE NUMBER 0 - 63 (1 - 64)		
00 02	00aa aaaa KEY SHIFT 0 - 48 (-24 - +24)		
00 03	0aaa aaaa FINE TUNE 0 - 100 (-50 - +50)		
00 04	000a aaaa BENDER RANGE 0 - 24		
00 05	0000 00aa ASSIGN MODE 0 - 3 (POLY 1, POLY 2, POLY 3, POLY 4)		
00 06	0000 0aaa REVERB SWITCH 0 - 1 (OFF, ON)		
00 07	0xxx xxxx dummy (ignored if received)		
00 08	0aaa aaaa OUTPUT LEVEL 0 - 100		
00 09	0000 aaaa PANPOT 0 - 14 (R - L)		
00 0A	0xxx xxxx dummy (ignored if received)		
00 0B	0xxx xxxx dummy (ignored if received)		
00 0C	0xxx xxxx dummy (ignored if received)		
00 0D	0xxx xxxx dummy (ignored if received)		
Total size		00 00 10	

*5-3 Rhythm part setup area

Offset address	Description	
00 00 00	Rhythm Setup (for Key# 24)	*5-3-1
00 00 04	Rhythm Setup (for Key# 25)	
00 00 08	Rhythm Setup (for Key# 26)	
00 00 0C	Rhythm Setup (for Key# 27)	
00 00 10	Rhythm Setup (for Key# 28)	
:	:	
:	:	
00 01 78	Rhythm Setup (for Key# 85)	
00 01 7C	Rhythm Setup (for Key# 87)	

*5-3-1 Rhythm setup (for each Key#)

Offset address	Description	
00 00	0aaa aaaa TIMBRE	0 - 93 (i01-164, r01-r30)
00 01	0aaa aaaa OUTPUT LEVEL	0 - 100
00 02	0000 aaaa PAHPOT	0 - 14 (R - L)
00 03	0000 000a REVERB SWITCH	0 - 1 (OFF, ON)
Total size		00 00 04

*5-4 Patch memory

Offset address	Description	
00 00	0000 00aa TIMBRE GROUP	0 - 3 (a, b, i, r)
00 01	00aa aaaa TIMBRE NUMBER	0 - 63
00 02	00aa aaaa KEY SHIFT	0 - 48 (-24 - +24)
00 03	0aaa aaaa FINE TUNE	0 - 100 (-50 - +50)
00 04	000a aaaa BENDER RANGE	0 - 24
00 05	0000 00aa ASSIGN MODE	0 - 3 (POLY 1, POLY 2, POLY 3, POLY 4)
00 06	0000 0aaa REVERB SWITCH	0 - 1 (OFF, ON)
00 07	0xxx xxxx dummy	
Total size		00 00 08

*5-5 System area

The total number of Partial reserves for 9 parts must be 32 or less. All Partial reserves must be sent as a package of 9 parts.

Offset address	Description	
00 00	0aaa aaaa MASTER TUNE	0 - 127 (432.1Hz - 457.6Hz)
00 01	0000 00aa REVERB MODE	0 - (Room, Hall, Plate, Tap delay)
00 02	0000 0aaa REVERB TIME	0 - 7 (1 - 8)
00 03	0000 0aaa REVERB LEVEL	0 - 7
00 04	00aa aaaa PARTIAL RESERVE (Part 1)	0 - 32
00 05	00aa aaaa PARTIAL RESERVE (Part 2)	0 - 32
00 06	00aa aaaa PARTIAL RESERVE (Part 3)	0 - 32
00 07	00aa aaaa PARTIAL RESERVE (Part 4)	0 - 32
00 08	00aa aaaa PARTIAL RESERVE (Part 5)	0 - 32
00 09	00aa aaaa PARTIAL RESERVE (Part 6)	0 - 32
00 0A	00aa aaaa PARTIAL RESERVE (Part 7)	0 - 32
00 0B	00aa aaaa PARTIAL RESERVE (Part 8)	0 - 32
00 0C	00aa aaaa PARTIAL RESERVE (Part 9)	0 - 32
00 0D	000a aaaa MIDI CHANNEL (Part 1)	0 - 16 (1 - 16, OFF)
00 0E	000a aaaa MIDI CHANNEL (Part 2)	0 - 16 (1 - 16, OFF)
00 0F	000a aaaa MIDI CHANNEL (Part 3)	0 - 16 (1 - 16, OFF)
00 10	000a aaaa MIDI CHANNEL (Part 4)	0 - 16 (1 - 16, OFF)
00 11	000a aaaa MIDI CHANNEL (Part 5)	0 - 16 (1 - 16, OFF)
00 12	000a aaaa MIDI CHANNEL (Part 6)	0 - 16 (1 - 16, OFF)
00 13	000a aaaa MIDI CHANNEL (Part 7)	0 - 16 (1 - 16, OFF)
00 14	000a aaaa MIDI CHANNEL (Part 8)	0 - 16 (1 - 16, OFF)
00 15	000a aaaa MIDI CHANNEL (Part 9)	0 - 16 (1 - 16, OFF)
00 16	0aaa aaaa MASTER VOLUME	0 - 100
Total size		00 00 17

Example of RQ1 and DT1 application --- 2

Assuming that MT-32 sets Unit # to 17, set Partial reserve of each part as follows by sending the byte string listed below.

Part 1 8 Parts 3 thru 8 0
Part 2 10 Rhythm part 8

F0 41 10 16 12 10 00 04 08 0A 00 00 00 00 00 08 66 F7

*5-6 Display

MT-32 deciphers incoming data and sends them to the LCD as a string of ASCII code characters. (In play mode)
Fiddling MT-32 panel switches or sending Display reset address data to MT-32 returns the display to the normal reading.
No display data in this area can be brought outside world by the use of RQ1 and RQD.

Offset address	Description	
00 00	0aaa aaaa DISPLAYED LETTER	32 - 127 (ASCII)
:	:	
00 13	0aaa aaaa DISPLAYED LETTER	
01 00	0xxx xxxx DISPLAY RESET	
Total size		00 00 14

*5-8 All Parameters Reset

*5-7 Write Reques

This message simulates write switch on MT-32, that is, MT-32 writes data of each part in the temporary area into internal memory. (Memory must be specified by two bytes addresses.) MT-32 will inform back of the writing result. No data in this area can be brought outside world by the use of RQ1 and RQD.

All parameters will be initialized by sending data to this address. No data in this area can be brought outside world through MIDI exclusive message such as RQ1 and RQD.

Offset address	Description
00 00	00aa aaaa Timbre Write (part 1) 0 - 63 (01 - 64)
00 01	0000 0000 0 (Internal)
00 02	00aa aaaa Timbre Write (part 2)
00 03	0000 0000
:	:
00 0E	00aa aaaa Timbre Write (part 8)
00 0F	0000 0000
01 00	0aaa aaaa Patch Write (part 1) 0 - 127 (A11 - B88)
01 01	0000 0000 0 (Internal)
01 02	0aaa aaaa Patch Write (part 2)
01 03	0000 0000
:	:
01 0E	0aaa aaaa Patch Write (part 8)
01 0F	0000 0000
10 00	0000 00aa Result 0 - 3 0 = Function Completed 1 = Incorrect Mode 2 = Incorrect Mode 3 = Incorrect Mode

Example of RQ1 and DT1 application --- 3

Assuming that MT-32 sets Unit # to 17, direct MT-32 to write data of Part 3 in the temporary area into #76 (B24) by sending the byte string listed below.

FD 41 10 16 12 40 01 04 4B 00 70 F7

Address	Block	Sub Block	Reference
02 00 00	Timbre Temp. (Basic Ch)	Common	5-1-1
		Partial 1	5-1-2
		Partial 2	
		Partial 3	
		Partial 4	
03 00 00	Patch Temp. (Unit#)	Part 1	5-2
		Part 2	
		Part 8	
		Part 8	
03 01 10	Rhyth Setup Temp(Unit#)	Note# 24	5-3-1
		Note# 25	
		Note# 86	
		Note# 87	
04 00 00	Timbre Temp. (Unit#)	Part 1	5-1
		Part 2	
		Part 7	
		Part 8	
05 00 00	Patch Memory	# 1	5-4
		# 2	
		#127	
		#128	
08 00 00	Timbre Memory	# 1	5-1
		# 2	
		# 63	
		# 64	
10 00 00	System Area		5-5
20 00 00	Display		5-6
40 00 00	Write Request		5-7
7F xx xx	All Parameters Reset		5-8

■Parameter base address

Start address	Description
00-00-00	Partial 3 (0 - 53)
00-00-40	Partial 4 (64 - 117)
00-01-0A	Upper Common (138 - 175)
00-01-40	Partial 1 (192 - 245)
00-02-00	Partial 2 (256 - 309)
00-02-4A	Lower Common (330 - 367)

■Partial parameters

Offset address	Description
00 01H	0aaa aaaa WG PITCH COARSE 0 - 72 (C1, C2, - C7)
00 01H	0aaa aaaa WG PITCH FINE 0 - 100 (-50 - +50)
00 02H	0000 aaaa WG PITCH KEYFOLLOW 0 - 16 (-1, -1/2, -1/4, 0, 1/8, 1/4, 3/8, 1/2, 5/8, 3/4, 7/8, 1, 5/4, 3/2, 2, si, s2)
00 03H	0xxx xxxx dummy
00 04H	0xxx xxxx dummy
00 05H	0000 000a WG PITCH BENDER SW 0 - 1 (OFF, ON)
00 06H	0000 000a WG WAVEFORM 0 - 1 (SQU, SAW)
00 07H	0aaa aaaa WG PCM WAVE # 0 - 99 (1 - 100)
00 08H	0aaa aaaa WG PULSE WIDTH 0 - 100
00 09H	0000 aaaa WG PW VELO SENS 0 - 14 (-7 - +7)
00 0AH	0xxx xxxx dummy
00 0BH	0xxx xxxx dummy
00 0CH	0xxx xxxx dummy
00 0DH	0aaa aaaa TVF CUTOFF FREQ 0 - 100
00 0EH	000a aaaa TVF RESONANCE 0 - 30
00 0FH	0000 aaaa TVF KEYFOLLOW 0 - 14 (-1, -1/2, -1/4, 0, 1/8, 1/4, 3/8, 1/2, 5/8, 3/4, 7/8, 1, 5/4, 3/2, 2)
00 10H	0aaa aaaa TVF BIAS POINT/DIR 0 - 127 (<1A - <7C >1A - >7C)
00 11H	0000 aaaa TVF BIAS LEVEL 0 - 14 (-7 - +7)
00 12H	0aaa aaaa TVF ENV DEPTH 0 - 100
00 13H	0aaa aaaa TVF ENV VELO SENS 0 - 100
00 14H	0000 0aaa TVF ENV DEPTH KEYF 0 - 4
00 15H	0000 0aaa TVF ENV TIME KEYF 0 - 4
00 16H	0aaa aaaa TVF ENV TIME 1 0 - 100
00 17H	0aaa aaaa TVF ENV TIME 2 0 - 100
00 18H	0aaa aaaa TVF ENV TIME 3 0 - 100
00 19H	0aaa aaaa TVF ENV TIME 4 0 - 100
00 1AH	0aaa aaaa TVF ENV TIME 5 0 - 100
00 1BH	0aaa aaaa TVF ENV LEVEL 1 0 - 100
00 1CH	0aaa aaaa TVF ENV LEVEL 2 0 - 100
00 1DH	0aaa aaaa TVF ENV LEVEL 3 0 - 100
00 1EH	0aaa aaaa TVF ENV SUSTAIN LEVEL 0 - 100
00 1FH	0xxx xxxx dummy
:	:
00 22H	0xxx xxxx dummy
00 23H	0aaa aaaa TVA LEVEL 0 - 100
00 24H	0aaa aaaa TVA VELO SENS 0 - 100
00 25H	0aaa aaaa TVA BIAS POINT 1 0 - 127 (<1A - <7C >1A - >7C)
00 26H	0000 aaaa TVA BIAS LEVEL 1 0 - 12 (-12 - 0)

00 27H	0aaa aaaa	TVA ENV TIME 1	0 - 100
00 28H	0aaa aaaa	TVA ENV TIME 2	0 - 100
00 29H	0aaa aaaa	TVA ENV TIME 3	0 - 100
00 2AH	0aaa aaaa	TVA ENV TIME 4	0 - 100
00 2BH	0aaa aaaa	TVA ENV TIME 5	0 - 100
00 2CH	0aaa aaaa	TVA ENV LEVEL 1	0 - 100
00 2DH	0aaa aaaa	TVA ENV LEVEL 2	0 - 100
00 2EH	0aaa aaaa	TVA ENV LEVEL 3	0 - 100
00 2FH	0aaa aaaa	TVA ENV SUSTAIN LEVEL	0 - 100
00 30H	0xxx xxxx	dummy	
00 31H	0000 0aaa	TVA ENV TIME V_FOLLOW	0 - 4
00 32H	0000 0aaa	TVA ENV TIME KEYF	0 - 4
00 33H	0xxx xxxx	dummy	
00 34H	0xxx xxxx	dummy	
00 35H	0xxx xxxx	dummy	
Total size		00 00 36H	

■Lower common parameter

Offset address	Description		
00 00H	0000 aaaa Structure of Partial# 1 & 2 0 - 12 (1 - 13)		
00 01H	0aaa aaaa P-ENV VELO SENS(Partial#1) 0 - 100		
00 02H	0000 0aaa P-ENV TIME KEYF(Partial#1) 0 - 4		
00 03H	0aaa aaaa P-ENV TIME 1(Partial#1) 0 - 100		
00 04H	0aaa aaaa P-ENV TIME 2(Partial#1) 0 - 100		
00 05H	0aaa aaaa P-ENV TIME 3(Partial#1) 0 - 100		
00 06H	0aaa aaaa P-ENV TIME 4(Partial#1) 0 - 100		
00 07H	0aaa aaaa P-ENV LEVEL 0(Partial#1) 0 - 100 (-50 - +50)		
00 08H	0aaa aaaa P-ENV LEVEL 1(Partial#1) 0 - 100 (-50 - +50)		
00 09H	0aaa aaaa P-ENV LEVEL 2(Partial#1) 0 - 100 (-50 - +50)		
00 0AH	0aaa aaaa P-ENV SUS LEVEL(Partial#1) 0 - 100 (-50 - +50)		
00 0BH	0aaa aaaa END LEVEL(Partial#1) 0 - 100 (-50 - +50)		
00 0CH	0xxx xxxx dummy		
00 0DH	0aaa aaaa P-LFO MOD SENS(Partial#1) 0 - 100		
00 0EH	0aaa aaaa P-LFO MOD SENS(Partial#2) 0 - 100		
00 0FH	0xxx xxxx dummy		
00 10H	0aaa aaaa P-LFO RATE(Partial#1) 0 - 100		
00 11H	0aaa aaaa P-LFO DEPTH(Partial#1) 0 - 100		
00 12H	0xxx xxxx dummy		
00 13H	0xxx xxxx dummy		
00 14H	0aaa aaaa P-LFO RATE(Partial#2) 0 - 100		
00 15H	0aaa aaaa P-LFO DEPTH(Partial#2) 0 - 100		
00 16H	0xxx xxxx dummy		
:	:		
00 23H	0xxx xxxx dummy		
00 24H	0000 00aa PARTIAL MUTE(Partial# 1&2) 0 - 3 (00 - 11)		
00 25H	0xxx xxxx dummy		
Total size		00 00 26H	

■ Upper common parameter

Offset address		Description	
00 00H	0000 aaaa	Structure of Partial# 3 & 4	0 - 12 (1 - 13)
00 01H	0aaa aaaa	P-ENV VELO SENS(Partial#3)	0 - 100
00 02H	0000 0aaa	P-ENV TIME KEYF(Partial#3)	0 - 4
00 03H	0aaa aaaa	P-ENV TIME 1(Partial#3)	0 - 100
00 04H	0aaa aaaa	P-ENV TIME 2(Partial#3)	0 - 100
00 05H	0aaa aaaa	P-ENV TIME 3(Partial#3)	0 - 100
00 06H	0aaa aaaa	P-ENV TIME 4(Partial#3)	0 - 100
00 07H	0aaa aaaa	P-ENV LEVEL 0(Partial#3)	0 - 100 (-50 - +50)
00 08H	0aaa aaaa	P-ENV LEVEL 1(Partial#3)	0 - 100 (-50 - +50)
00 09H	0aaa aaaa	P-ENV LEVEL 2(Partial#3)	0 - 100 (-50 - +50)
00 0AH	0aaa aaaa	P-ENV SUS LEVEL(Partial#3)	0 - 100 (-50 - +50)
00 0BH	0aaa aaaa	END LEVEL(Partial#3)	0 - 100 (-50 - +50)
00 0CH	0xxx xxxx	dummy	
00 0DH	0aaa aaaa	P-LFO MOD SENS(Partial#3)	0 - 100
00 0EH	0aaa aaaa	P-LFO MOD SENS(Partial#4)	0 - 100
00 0FH	0xxx xxxx	dummy	
00 10H	0aaa aaaa	P-LFO RATE(Partial#3)	0 - 100
00 11H	0aaa aaaa	P-LFO DEPTH(Partial#3)	0 - 100
00 12H	0xxx xxxx	dummy	
00 13H	0xxx xxxx	dummy	
00 14H	0aaa aaaa	P-LFO RATE(Partial#4)	0 - 100
00 15H	0aaa aaaa	P-LFO DEPTH(Partial#4)	0 - 100
00 16H	0xxx xxxx	dummy	
:	:		
00 23H	0xxx xxxx	dummy	
00 24H	0000 00aa	PARTIAL MUTE(Partial# 3&4)	0 - 3 (00 - 11)
00 25H	0xxx xxxx	dummy	
Total size		00 00 26H	

Function ***		Transmitted	Recognized	Remarks
Basic Channel	Default	x	2 - 10	
	Changed	x	1 - 8, 10	
Mode	Default	x	3	
	Messages	x	x	
	Altered	*****		
Note Number	True Voice	x	0 - 127	
		*****	12 - 108	
Velocity	Note ON	x	○ v = 1 - 127	
	Note OFF	x	x	
After Touch	Key's	x	x	
	Ch's	x	x	
Pitch Bender		x	○	
Control Change	1	x	○	Modulation
	2 - 5	x	x	
	6	x	*	Data Entry
	7	x	○	Volume
	6 - 9	x	x	
	10	x	○	Pan
	11	x	○	Expression
	12 - 63	x	x	
	64	x	○	Hold 1
	65 - 99	x	x	
	100,101	x	* (0)	RPC LSB, MSB
102 - 120	x	x		
121	x	○	Resets All Controllers	
Prog Change	True #	x	○ 0 - 127	
		*****	0 - 127	
System Exclusive		○	○	
System Common	Song Pos	x	x	
	Song Sel	x	x	
	Tune	x	x	
System Real Time	Clock	x	x	
	Commands	x	x	
Aux Message	Local ON/OFF	x	x	
	All Notes OFF	x	○ (123 - 127)	
	Active Sense	x	○	
	Reset	x	x	

Notes * RPC = Registered Parameter Control Number
 RPC # 0 : Pitch Bend Sensitivity
 The value of parameter is to be determined by entering data.

MT-32

Sound List



Prog-No. [HP-Prog] Use Partial
Timbre name

PRESET TIMBRE MAP

BASS															
065 [B11]	2	066 [B12]	1	067 [B13]	2	068 [B14]	1	069 [B15]	3	070 [B16]	2	071 [B17]	4	072 [B18]	2
Acou Bass 1		Acou Bass 2		Elec Bass 1		Elec Bass 2		Slap Bass 1		Slap Bass 2		Fretless 1		Fretless 2	
WIND 1															
073 [B21]	4	074 [B22]	2	075 [B23]	3	076 [B24]	2	077 [B25]	2	078 [B26]	3	079 [B27]	4	080 [B28]	3
Flute 1		Flute 2		Piccolo 1		Piccolo 2		Recorder		Pan Pipes		Sax 1		Sax 2	
081 [B31]	2	082 [B32]	1	083 [B33]	3	084 [B34]	2	085 [B35]	2	086 [B36]	2	087 [B37]	2	088 [B38]	2
Sax 3		Sax 4		Clarinet 1		Clarinet 2		Oboe		Engl Horn		Bassoon		Harmonica	
BRASS															
089 [B41]	3	090 [B42]	2	091 [B43]	3	092 [B44]	2	093 [B45]	3	094 [B46]	2	095 [B47]	2	096 [B48]	4
Trumpet 1		Trumpet 2		Trombone 1		Trombone 2		Fr Horn 1		Fr Horn 2		Tuba		Brs Sect 1	
MALLETS															
097 [B51]	3	098 [B52]	3	099 [B53]	2	100 [B54]	1	101 [B55]	3	102 [B56]	2	103 [B57]	4	104 [B58]	1
Brs Sect 2		Vibe 1		Vibe 2		Syn Mallet		Windbell		Glock		Tube Bell		Xylophone	
SPECIAL															
105 [B61]	3	106 [B62]	2	107 [B63]	4	108 [B64]	4	109 [B65]	2	110 [B66]	1	111 [B67]	4	112 [B68]	3
Marimba		Koto		Sho		Shakuhachi		Whistle 1		Whistle 2		Bottleblow		Breathpipe	
PERCUSN															
113 [B71]	2	114 [B72]	1	115 [B73]	2	116 [B74]	2	117 [B75]	2	118 [B76]	3	119 [B77]	1	120 [B78]	2
Timpani		Melodic Tom		Deep Snare		Elec Perc 1		Elec Perc 2		Taiko		Taiko Rim		Cymbal	
EFFECTS															
121 [B81]	2	122 [B82]	2	123 [B83]	4	124 [B84]	1	125 [B85]	1	126 [B86]	4	127 [B87]	3	128 [B88]	4
Castanets		Triangle		Orche Hit		Telephone		Bird Tweet		One Note Jam		Water Bells		Jungle Tune	

Information

- Please use this AC adaptor only with the specified device.
- Please use the AC Adaptor of an appropriate voltage (120, 220 or 240) depending on the voltage system in your country.
- When the device is not be used for a long period, be sure to disconnect the AC adaptor (Power Supply Unit) from the wall outlet.
- When you need repair service, call your local Roland Service Station as shown below or the authorized Roland distributor in your country.

U . S . A .

Roland Corp US
7200 Dominion Circle
Los Angeles, CA. 90040 -3647
U. S . A.
☎ (213) 685 -5141

CANADA

Roland Canada Music Ltd.
(Head Office)
13880 Mayfield Place
Richmond B.C., V6V 2E4
CANADA
☎ (604) 270-6626

Roland Canada Music Ltd.
3469 rue Ashby,
St Laurent,
Quebec H4R 2C1
CANADA
☎ (514) 335 -2009

Roland Canada Music Ltd.
Unit B-12, 1515 Matheson Blvd
Mississauga, Ontario L4W 2P5
CANADA
☎ (416) 625 -4880

AUSTRALIA

Roland Corporation
(Australia) Pty. Ltd.
(Head Office)
38 Campbell Avenue
Dee Why West NSW 2099
AUSTRALIA
☎ (02) 982- 8286

Roland Corporation
(Australia) Pty. Ltd.
(Melbourne Office)
50 Garden Street
South Yarra, Victoria 3141
AUSTRALIA
☎ (03) 241 -1254

NEW ZEALAND

Roland Corporation (NZ) Ltd.
97 Mt. Eden Road, Mt. Eden,
Auckland 3
NEW ZEALAND
☎ (09) 398 -715

UNITED KINGDOM

Roland (UK) Ltd.
Amalgamated Drive
West Cross Centre, Brentford,
Middlesex TW8 9EZ,
UNITED KINGDOM
☎ (01) 568-4578

WEST GERMANY

Roland Elektronische
Musikinstrumente
Handelsgesellschaft mbH
Oststrasse 96,
2000 Norderstedt
WEST GERMANY
☎ 040/526 009-28

BELGIUM/HOLLAND/ LUXEMBOURG

Roland Benelux N.V.
Houtstraat 1
B-2431 Oevel-Westerlo
BELGIUM
☎ 014-58 45 39

DENMARK

Roland Scandinavia A/S
Nordre Sogade 49, 1370
Copenhagen K.
DENMARK
☎ (01) 11 31 11

SWEDEN

Roland Scandinavia A/S
Swedish Sales Office
DanvikCenter 28A, 2tr.
S-131 30 Nacka,
SWEDEN
☎ 08-702 00 20

NORWAY

Benum Music A/S
Haakon den godes Vei 14
N-0319 Oslo 3,
NORWAY
(Box 145 Vindern, N-0319
Oslo 3 NORWAY)
☎ 02 141266

FINLAND

OY Musiikki Fazer Musik AB
Takomotie 3
00380 Helsinki 38,
FINLAND
☎ 05 56551

ITALY

Roland Italy S.P. A.
Via Gallarate 58
20151 Milano
ITALY
☎ 02-3086849

SWITZERLAND

Musitronic AG
Gerberstrasse 5, CH-4410
Liestal
SWITZERLAND
☎ 061/921 16 15

FRANCE

Musikengro
102, Avenue Jean-Jaures
69367 Lyon Cedex 07
FRANCE
☎ (7) 858-54 60

Musikengro
(Paris Office)
Centre Region Parisienne
41 rue Charles-Fourier, 94400
Vitry s/Seine
FRANCE
☎ (1) 4680 86 62

SPAIN

Vietronic S.A.
Bolivia 239
08020 Barcelona
SPAIN
☎ 34-307 47 12

AUSTRIA

E. Dematte & Co.
Nue-Rum Siemens-Strasse 4
A-6021 Innsbruck box 591
AUSTRIA
☎ 43 (05222) 63 4510

GREECE

A. ANDREADES & Co. Ltd.
Fidiou Str., 106 78
Athens
GREECE
☎ 3620130

Roland®

10650

UPC

10650



10650

MT-32

2701046700

88-10-83-81

Roland