

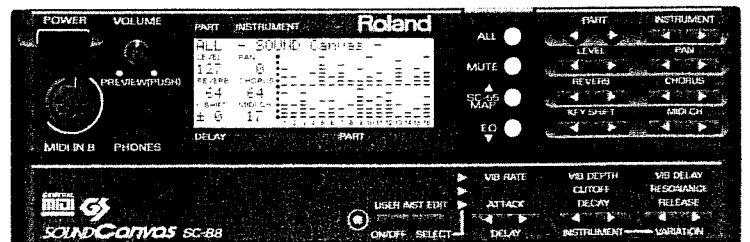

Roland®

OWNER'S MANUAL

SOUND Canvas

MIDI SOUND GENERATOR SC-88



	CAUTION RISK OF ELECTRIC SHOCK DO NOT OPEN	
ATTENTION RISQUE DE CHOC ELECTRIQUE NE PAS OUVRIIR		
<p>CAUTION: TO REDUCE THE RISK OF ELECTRIC SHOCK, DO NOT REMOVE COVER (OR BACK). NO USER-SERVICEABLE PARTS INSIDE. REFER SERVICING TO QUALIFIED SERVICE PERSONNEL.</p>		



The lightning flash with arrowhead symbol, within an equilateral triangle, is intended to alert the user to the presence of uninsulated "dangerous voltage" within the product's enclosure that may be of sufficient magnitude to constitute a risk of electric shock to persons.



The exclamation point within an equilateral triangle is intended to alert the user to the presence of important operating and maintenance (servicing) instructions in the literature accompanying the product.

INSTRUCTIONS PERTAINING TO A RISK OF FIRE, ELECTRIC SHOCK, OR INJURY TO PERSONS.

IMPORTANT SAFETY INSTRUCTIONS SAVE THESE INSTRUCTIONS

WARNING - When using electric products, basic precautions should always be followed, including the following:

1. Read all the instructions before using the product.
2. Do not use this product near water — for example, near a bathtub, washbowl, kitchen sink, in a wet basement, or near a swimming pool, or the like.
3. This product should be used only with a cart or stand that is recommended by the manufacturer.
4. This product, either alone or in combination with an amplifier and headphones or speakers, may be capable of producing sound levels that could cause permanent hearing loss. Do not operate for a long period of time at a high volume level or at a level that is uncomfortable. If you experience any hearing loss or ringing in the ears, you should consult an audiologist.
5. The product should be located so that its location or position does not interfere with its proper ventilation.
6. The product should be located away from heat sources such as radiators, heat registers, or other products that produce heat.
7. The product should be connected to a power supply only of the type described in the operating instructions or as marked on the product.
8. The power-supply cord of the product should be unplugged from the outlet when left unused for a long period of time.
9. Care should be taken so that objects do not fall and liquids are not spilled into the enclosure through openings.
10. The product should be serviced by qualified service personnel when:
 - A. The power-supply cord or the plug has been damaged; or
 - B. Objects have fallen, or liquid has been spilled onto the product; or
 - C. The product has been exposed to rain; or
 - D. The product does not appear to operate normally or exhibits a marked change in performance; or
 - E. The product has been dropped, or the enclosure damaged.
11. Do not attempt to service the product beyond that described in the user-maintenance instructions. All other servicing should be referred to qualified service personnel.

For the USA

This product may be equipped with a polarized line plug (one blade wider than the other). This is a safety feature. If you are unable to insert the plug into the outlet, contact an electrician to replace your obsolete outlet. Do not defeat the safety purpose of the plug.

For Canada

For Polarized Line Plug

CAUTION: TO PREVENT ELECTRIC SHOCK, MATCH WIDE BLADE OF PLUG TO WIDE SLOT, FULLY INSERT.

ATTENTION: POUR ÉVITER LES CHOCS ÉLECTRIQUES, INTRODUIRE LA LAME LA PLUS LARGE DE LA FICHE DANS LA BORNE CORRESPONDANTE DE LA PRISE ET POUSSER JUSQU' AU FOND.

For the U.K.

IMPORTANT: THE WIRES IN THIS MAINS LEAD ARE COLOURED IN ACCORDANCE WITH THE FOLLOWING CODE.

BLUE	: NEUTRAL
BROWN	: LIVE

As the colours of the wires in the mains lead of this apparatus may not correspond with the coloured markings identifying the terminals in your plug, proceed as follows:

The wire which is coloured BLUE must be connected to the terminal which is marked with the letter N or coloured BLACK.
The wire which is coloured BROWN must be connected to the terminal which is marked with the letter L or coloured RED.

Roland®









*SOUND***Canvas** SC-88



MIDI SOUND GENERATOR

Introduction

Main features of the SC-88 Sound Canvas

- The SC-88 is a sound module compatible with the GM system. It can be used to playback any song data (GM scores) bearing the GM mark. The SC-88 is also compatible with the Roland GS format. It can be used to playback any song data bearing the GS mark.
- The SC-88 is a 32 part 64 voice multi-timbral sound module. A single SC-88 can produce the sounds of a large ensemble. It is an ideal sound module for use with sequencers or personal computers. ( p.5-1)
- The SC-88 contains 654 high quality sounds and 24 types of drum sound set (including 2 sound effects sets). These sound include the same sounds as the SC-55/55mkII, allowing SC-55/55mkII song data to be played back correctly.
- There are 256 user sounds and 2 user drum sets, allowing you to create your own sounds and drum sets. ( p.4-2, 5)
- By editing sound parameters such as vibrato, filter and envelope, you can modify sounds to your taste. ( p.2-17)
- A wide variety of effects are provided, including 8 types of reverb, 8 types of chorus, 10 types of delay, and 2-band equalization. In addition, for each effect you can specify parameters such as character, depth, rate, time, frequency etc., to make fine adjustments to the sound. ( p.3-2)
- The computer connector allows the SC-88 to be directly connected to an Apple, IBM or NEC personal computer. ( p.5-2)
- The large display screen graphically provides easy visual confirmation of settings such as volume for each part, and pictures and character data can also be displayed in the dot matrix (ten screens). ( p.4-12)
- A wide variety of sound parameters can be edited directly and easily by pressing dedicated buttons. ( p.1-5)
- Audio input jacks with input level adjustment allow you to connect another sound source, and output it from the audio output jacks mixed with the SC-88's own sound. ( p.1-9)



GM system

The GM (General MIDI) system is a set of recommendations which seek to provide a way to go beyond the limitations of proprietary designs, and standardize the MIDI capabilities of sound generating devices. Sound generating devices and sound data that meets the GM standard bears the GM logo (). Song data bearing the GM logo can be played back using any GM sound generating unit to produce essentially the same musical performance.



GS format

The GS format is Roland's unified set of specifications to standardize the MIDI capabilities of sound generating devices. Song data bearing the GS logo () can be played back using any GS sound generating unit.

The SC-88 supports both GM and GS, and can be used to playback song data carrying either of these logos.

Apple is a registered trademark of Apple Computer, Inc.
Macintosh is a trademark of Apple Computer, Inc.
IBM, PC/AT are registered trademarks of International Business Machines Corporation.

IMPORTANT NOTES

In addition to the items listed under Safety Precautions inside the front cover, please read and observe the following:

Power Supply

- Before connecting this unit to other devices, turn off the power to all units; this will help prevent damage or malfunction.
- Do not use this unit on the same power circuit with any device that will generate line noise; an electric motor or variable lighting system for example.

Placement

- Using the unit near power amplifiers (or other equipment containing large power transformers) may induce hum.
- This device may interfere with radio and television reception. Do not use this device in the vicinity of such receivers.
- Do not expose the unit to temperature extremes or install it near devices that radiate heat. Direct sunlight in an enclosed vehicle can deform or discolor the unit.

Maintenance

- For everyday cleaning wipe the unit with a soft, dry cloth or one that has been slightly dampened with water. To remove stubborn dirt, use a mild, non-abrasive detergent. Afterwards, be sure to wipe the unit thoroughly with a soft, dry cloth.
- Never use benzene, thinners, alcohol or solvents of any kind, to avoid the possibility of discoloration and/or deformation.

Additional Precautions

- Protect the unit from strong impact.
- Never strike or apply strong pressure to the display.
- A small amount of heat will radiate from the unit during normal operation.
- Before using the unit in a foreign country, consult with qualified service personnel.
- A small amount of noise may be heard from the display during normal operation.

Memory Backup

- This unit contains a battery which powers the unit's memory circuits while the main (AC) power is off. The expected life of this battery is 5 years or more. However, to avoid the untimely loss of memory data, it is strongly recommended that you change the battery every 5 years. Please be aware that the actual life of the battery will depend upon the physical environment -- especially the temperature -- in which the unit is used. When it is time to change the battery, consult with qualified service personnel.
- When the battery becomes weak the following message will appear in the display: "Battery Low". Please change the battery as soon as possible to avoid the loss of memory data.
- Please be aware that the contents of memory may at times be lost; when the unit is sent for repairs or when by some chance a malfunction has occurred. Important data should be stored on a computer or sequencer (see p.4-10). During repairs, due care is taken to avoid the loss of data. However, in certain cases (such as when circuitry related to memory itself is out of order), we regret that it may not be possible to restore the data.

About this owner's manual

Parameter names are often abbreviated in the SC-88's display. For example, Chorus Rate is abbreviated as 'Cho Rate. The full name of the parameter will be used in the manual to avoid any confusion.

If a parameter's value is continuously variable, it will be shown as being a number from 0 — 127. If, on the other hand, a parameter value is selectable in discrete steps, those steps will be shown as 200, 400Hz (for example).

Panel buttons are indicated within square brackets [▶], such as [CHORUS].

Regarding Screen Displays

Where possible, we will use the actual screen displays for explanations. Keep in mind, however, that the displays of your SC-88 may vary slightly depending on your instrument's settings.

CONTENTS

Introduction	0-2
IMPORTANT NOTES	0-3
CONTENTS	0-4
Front and rear panel	0-6

Chapter 1. Try out the SC-88 (Quick start)

■ Connect a MIDI keyboard and play the sounds....	1-2
● Making connections	1-2
● Turning the power on or off	1-3
● Is there sound?	1-3
■ Try out the various sounds.....	1-4
■ Try out the buttons of the SC-88.....	1-5
■ Apply effects to the sound.....	1-7
■ Tuning to other instruments (Tuning).....	1-8
■ Headphones.....	1-9
■ Audio output jacks / Audio input volume	1-9

Chapter 2. Parts and parameters

■ Parts and sounds	2-2
● Assigning a sound to a Part	2-2
● Selecting Variation sounds.....	2-4
● Reading the Instrument numbers and Variation numbers.....	2-5
● Part Channels	2-7
● Which MIDI IN will be used by each Part?	2-8
● How simultaneous note numbers and Voices are related.....	2-9
■ Part parameters for performance	2-10
[1] Parameters that can be set directly using the buttons....	2-10
[2] Parameters that must be selected from the menu.....	2-11
● What each parameter does.....	2-12
■ Part parameters for sound editing.....	2-17
● Procedure.....	2-17
● What each parameter does.....	2-18
● Vibrato.....	2-18
● Filter	2-19
● Envelope	2-20

■ Setting parameters common to all Parts.....	2-21
● Procedure.....	2-21
● How each parameter works	2-22
■ System parameter settings	2-24
● Procedure.....	2-24
● How each System parameter works	2-25
■ Creating a Drum Set (Drum Edit).....	2-28
● Drum editing procedure.....	2-28

Chapter 3. Effect

■ Effect settings.....	3-2
● Equalizer setting procedure	3-2
● Equalizer parameter functions	3-3
● When you want to adjust effect depth for all Parts.....	3-4
● When you want to adjust effect depth for each Part	3-4
● Setting Reverb/Chorus/Delay parameters	3-5
● Reverb/Chorus/Delay parameter functions	3-6
● Reverb parameters	3-7
● Chorus parameters	3-8
● Delay parameters.....	3-9
● About the SC-88's effect structure	3-10

Chapter 4. Convenient functions

- Create and save a sound (User Instrument Edit)4-2
- Saving a Drum Set you created (User Drum Edit)4-5
- Create a display message.....4-8
- Recording all settings on a sequencer4-10
- Draw pictures or characters
in the display (Frame Draw)4-12
- Selecting the CM-64 sound map4-14
 - Differences between the CM-64
and the SC-88.....4-15
- Using the SC-88 as two sound modules4-16
 - Selecting Double Module Mode4-16
- Initialize4-18
 - Initialize all Parts to the factory settings4-18
 - Initialize for GM/GS4-18

Chapter 5. Using the SC-88 from a personal computer

- Using the SC-88 from a personal computer ...5-2
 - Connections with your computer5-2
 - MIDI data transfer with the computer5-5
 - Connecting another MIDI sound source
to the SC-885-7
- Using MIDI messages to select sounds5-8
 - Using MIDI messages to select Drum Sets...5-10

Chapter 6. MIDI and the SC-88

- About MIDI6-2
 - How MIDI messages are transmitted and received6-2
 - MIDI channels and multi-timbral sound modules.....6-3
- MIDI messages that can be received by the SC-886-4
 - Device ID number settings6-9
- MIDI message routing settings and switches6-10
 - [1] Parameters which apply to all Parts (A)6-10
 - [2] Parameters which can be set individually
for each Part (B).....6-14
 - [3] Parameters which can be set individually
for each Part6-16
- The General MIDI System and GS Format.....6-17
 - What is the GM System?6-17
 - What is the GS Format?.....6-17

Chapter 7. Appendix

- Troubleshooting7-2
- If a message appears.....7-4
- Computer cable wiring diagrams.....7-5
- Parameter list and operations7-6
- Instrument list.....7-10
- Drum set list7-16
- MIDI implementation7-21
- MIDI implementation chart7-37
- INDEX7-38
- Specifications7-40
- How to use the included floppy disk
for the SC-887-41
- Information7-42

Chapter 1

Chapter 2

Chapter 3

Chapter 4

Chapter 5

Chapter 6

Chapter 7

Front and rear panel

■ Front panel

● **MIDI IN B connector (front)** (☞ p.6-10)
 When IN B Select is set to Rear (the factory setting), the front MIDI IN B connector cannot be used.

- Power switch (☞ p.1-3)
- Volume knob (☞ p.1-3)
- Preview switch (☞ p.1-3)
- Headphone jack (☞ p.1-9)
- Display screen (☞ p.2-27)
- Bar display (☞ p.2-8, 2-26)

- All button (☞ p.2-17)
- Mute button (☞ p.2-10, 2-21)
- SC-55 Map button (☞ p.2-10, 2-21)
- Equalizer button (☞ p.2-10, 2-21)
- Part buttons (☞ p.2-2)
- Level buttons (☞ p.2-10, 2-21)
- Reverb buttons (☞ p.3-4)
- Key Shift buttons (☞ p.2-10, 2-21)
- Instrument buttons (☞ p.2-2)
- Pan buttons (☞ p.2-10, 2-21)
- Chorus buttons (☞ p.3-4)
- MIDI Channel buttons (☞ p.2-7)
- * While holding down the [◀] button, you can press the [▶] button to make the value change faster.

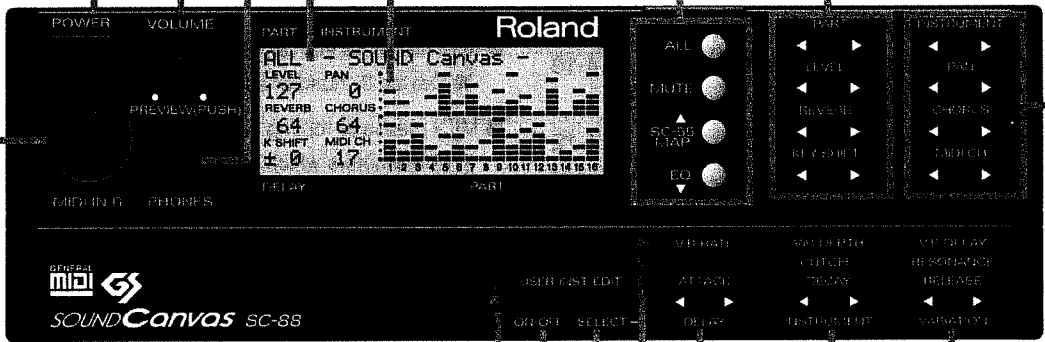

- User Edit indicator (☞ p.4-3, 4-5)
- User Edit On/Off button (☞ p.4-3, 4-5)
- Select button (☞ p.2-17, 4-3, 4-5)
- Select indicator (☞ p.2-17, 4-3, 4-5)

- Delay buttons (☞ p.3-4)
- Vibrato Rate buttons (☞ p.2-18)
- Envelope Attack buttons (☞ p.2-20)
- Instrument buttons (☞ p.1-4)
- Vibrato Depth buttons (☞ p.2-8)
- Filter Cutoff Frequency buttons (☞ p.2-19)
- Envelope Decay buttons (☞ p.2-20)

■ Rear panel

● **MIDI OUT/THRU connector**
 This connector functions either as MIDI OUT or MIDI THRU, depending on the setting of OUT/THRU Select (☞ p.6-11). When the unit is shipped, this is set to MIDI OUT.

- MIDI IN A connector (☞ p.6-2)
- MIDI IN B connector (rear) (☞ p.6-10)

- Variation buttons (☞ p.2-4, 2-6)
- Vibrato Delay buttons (☞ p.2-18)
- Filter Resonance buttons (☞ p.2-19)
- Envelope Release buttons (☞ p.2-20)

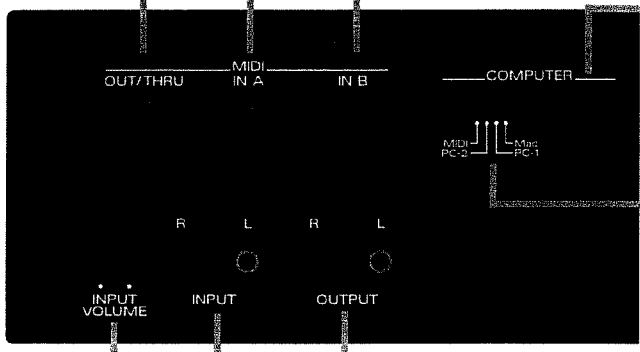

● **Computer connector**
 A special computer cable (sold separately) can be connected here. The type of cable required will depend on your computer. When the Computer switch located at the left is set to MIDI, the computer connector cannot be used (☞ p.5-2).

● **Computer switch**
 Set this switch depending on the type of computer connected to the Computer connector, or the software you are using. Turn the power off before changing the setting of this switch. If you wish to use the MIDI connectors, set this switch to MIDI. (☞ p.5-2)

- Audio output jacks (☞ p.1-2)
- Audio input jacks (☞ p.1-9)
- Audio input volume knob (☞ p.1-9)

Chapter 1

**Try out the SC-88
(Quick start)**

■ Connect a MIDI keyboard and play the sounds

● Making connections

* This section explains how to connect the SC-88 to a MIDI keyboard and play the sounds. If you wish to connect a sequencer or personal computer to the SC-88, refer to p.5-2.

Set the Computer select switch located on the back of the SC-88 to MIDI.

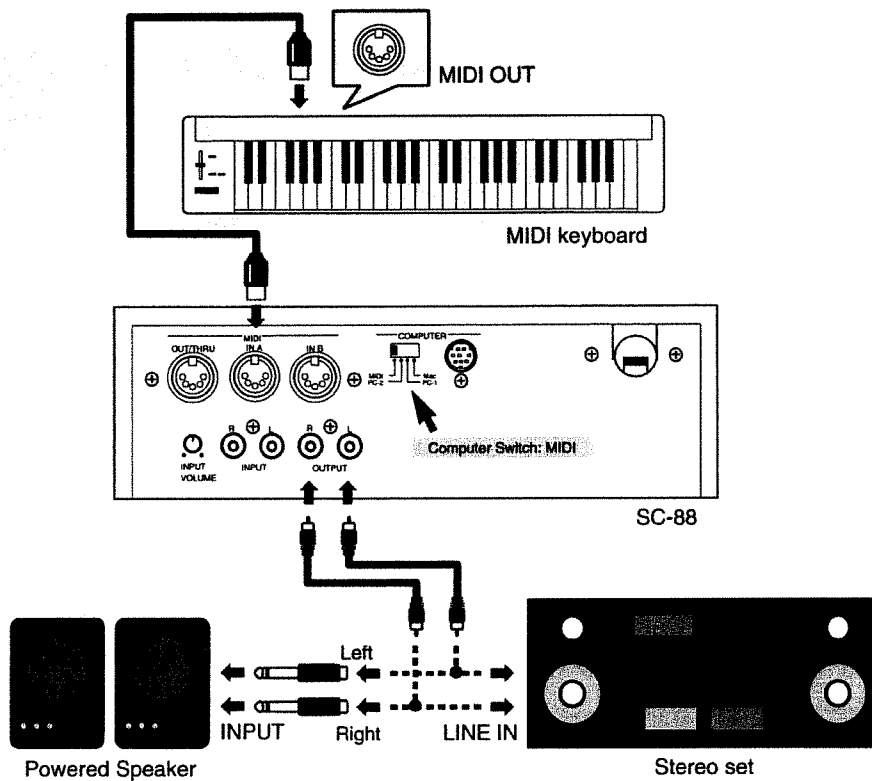

* The included audio cable can be used as a "pin ↔ phone" cable with the adaptor attached, or as a "pin ↔ pin" cable with the adaptor removed.

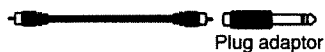

● Turning the power on or off

○ Turning the power on

1. Before you turn the power on, check the following points.

Make sure that the power cables of each device are correctly plugged into an AC outlet.
Make sure that the SC-88 is correctly connected to any peripheral devices you are using ([see](#) p.1-2).
Make sure that the volume of your amp/speaker system is turned down.

2. Turn on the power of the SC-88 and your MIDI equipment.

The following display will appear.

3. Turn on the power of your audio system.

Set your amplifier to an appropriate volume.

- * For a short time immediately after the SC-88 is turned on, an internal protection circuit will operate and the unit will produce no sound.
- * Excessive volumes can damage your speaker system. Please be aware that speakers used in conventional stereo systems are more vulnerable to being damaged by high volume levels than are speakers designed for musical instruments.
- * Is the SC-88 is placed at an angle where the display is difficult to read, adjust the LCD Contrast ([see](#) p.2-24).
- * To restore the factory settings, refer to p.4-18.

○ Turning the power off

1. Before you turn the power off, check the following points.

Make sure that the volume of your amp/speaker system is turned down.

2. Turn off each device in the following order.

Audio devices → SC-88 and MIDI devices

● Is there sound?

After making connections as explained in "Making connections", turn the power on, and gradually raise the volume while playing the keyboard. Does the bar indicator of the SC-88 move? If it does, the SC-88 is receiving MIDI messages correctly.

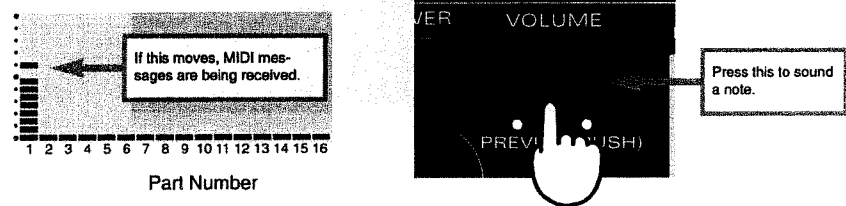

The SC-88 will sound a note when the Volume knob is pressed (the Preview function). If playing your keyboard produces no sound, you can use this function to see whether the amp volume and speaker connections are correct.

If the SC-88 bar indicator does not move, MIDI messages are not being received from your MIDI keyboard. Check your MIDI keyboard settings and MIDI cable connections.

If you hear sound but the bar indicator does not move, press the [ALL] button to make the [ALL] indicator light. Now the volume levels of all the Parts of the SC-88 will be indicated in the display ([see](#) P.2-8).

- * With the factory settings, the SC-88 will produce sound in response to any channel 1 — 16, regardless of the transmit channel your keyboard is set to. This is because each Part is assigned to the correspondingly numbered MIDI channel. The number below the bar indicator is the Part number.
- * If you hear sound but the bar indicator does not move, press the [ALL] button to make the [ALL] indicator light. Now the volume levels of all the Parts of the SC-88 will be indicated in the display ([see](#) p.2-8).

■ Try out the various sounds

The SC-88 contains a wide variety of sounds, including not only musical instruments such as piano, organ and guitar, but also sound effects such as birds and telephone rings. In the SC-88, each of these sounds is called an "Instrument" (see p.7-10). A group of Instruments is called a "Map."

The SC-88 has two maps; an SC-88 map which contains original sounds, and an SC-55 map which contains the same sounds as the SC-55/SC-55mkII (see p.2-5, 7-10). Here's how to select instruments or maps to try out the sounds.

1. Make sure that the [ALL] indicator is dark.

If it is lit, press the [ALL] button to turn it off.

2. Use INSTRUMENT [◀] [▶] to select sounds. Play and listen the sounds of the SC-88 Map.

Pressing INSTRUMENT [◀] will move to a lower-numbered sound, and pressing INSTRUMENT [▶] will move to a higher-numbered sound.

While holding down the [▶] ([◀]) button, press the [◀] ([▶]) button, the value will change faster.

3. To select the SC-55 map, press the [SC-55MAP] button to make the indicator light.

Use the INSTRUMENT [◀] [▶] buttons to select instruments, and listen the sound of the SC-55 MAP.

When SC-55 map sounds are selected, a "" mark will be displayed at the left of the sound name. When the indicator is dark, the SC-88 map is selected.

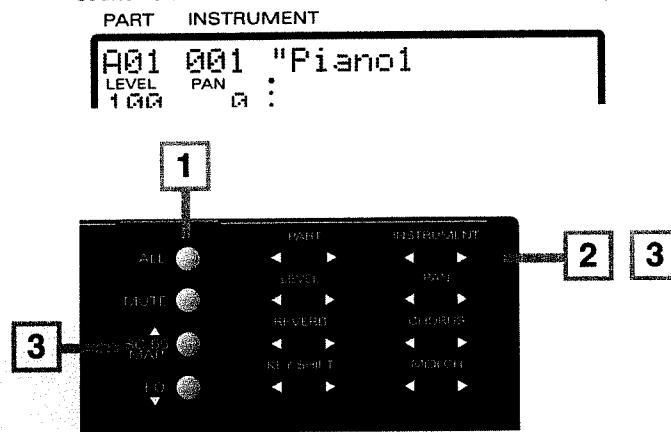

* If you press a sound select button on your MIDI keyboard, the SC-88 sound will change.

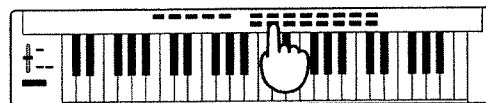

MIDI keyboard

■ Try out the buttons of the SC-88

● Preview the sound (Preview p.2-25)

When you press the Volume knob, the currently selected instrument will sound. You can specify the pitch and volume at which this preview note will be sounded ( p.2-24). This preview function is convenient when you wish to check sounds or adjust the tuning when a keyboard is not connected.

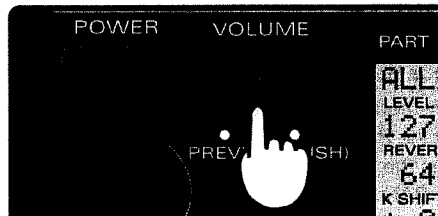

The following procedures must be performed with the [ALL] button indicator dark. If it is lit, press the [ALL] button to turn it off.

● Select a Variation sound

Using the INSTRUMENT buttons you can select 128 sounds, but the SC-88 has even more sounds than this. These other sounds are called Variation sounds, and can be selected using the VARIATION buttons.

1. **Make sure that all three of the [SELECT] indicators are dark.**
If they are lit, press the [SELECT] button to turn them off.
2. **Use the VARIATION [◀] [▶] buttons to select Variation sounds.**

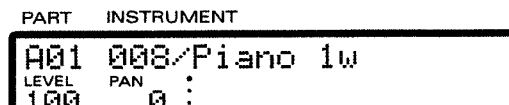

Pressing VARIATION [◀] will move to a lower-numbered sound, and pressing VARIATION [▶] will move to a higher-numbered sound (Variation sounds.)

Together, the INSTRUMENT [◀] [▶], VARIATION [◀] [▶] and [SC-55MAP] buttons allow you to access all the sounds of the SC-88.

- * Some of the Variation numbers are not in continuous sequence.
- * For details on selecting sounds, refer to p.2-2.

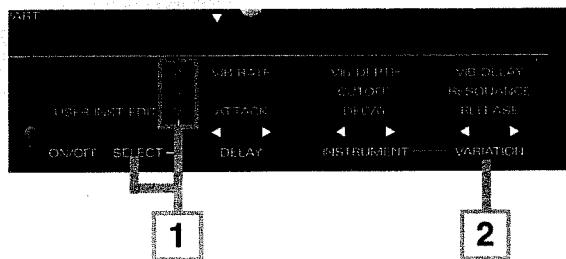

● Volume adjustments

Volume adjusts the loudness of the sound. Press LEVEL [▶] to increase the volume, and press LEVEL [◀] to decrease the volume.

● Pan adjustments (stereo position)

Pan sets the stereo position of the sound when a stereo playback system is used. Use the PAN [◀] [▶] buttons to set the pan. For example, the drum set and bass might be placed in the center, the guitar at right, and the keyboard at left. To place a sound in the center, set the Pan value to 0. As the L-value increases the sound will be placed further left, and as the R-value increases the sound will be placed further right. If you continue pressing PAN [◀], "Rnd" (random) will be selected, and each note will be placed at a random stereo position.

- * For some instruments, small amounts of leakage may be heard from the opposite speaker even when pan has been set fully left or right.
- * If you are listening in mono, pan settings will have no effect.

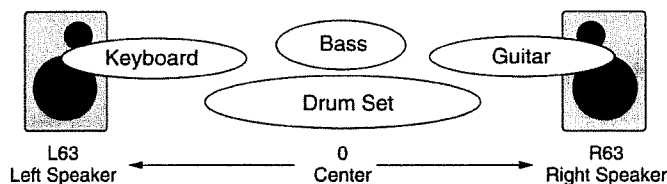

● Transpose the pitch

You can transpose the pitch of the sound in semitone steps. Pressing KEY SHIFT [◀] will lower the key (pitch), and pressing KEY SHIFT [▶] will raise the key (pitch).

- * The area of the screen where the Key Shift setting is displayed is shared with the Delay display. When the DELAY buttons are pressed the delay setting will be displayed, and when you press the KEY SHIFT buttons the key shift setting will be displayed. If the display indicates a +/- (plus or minus) value, the key shift setting is being displayed.

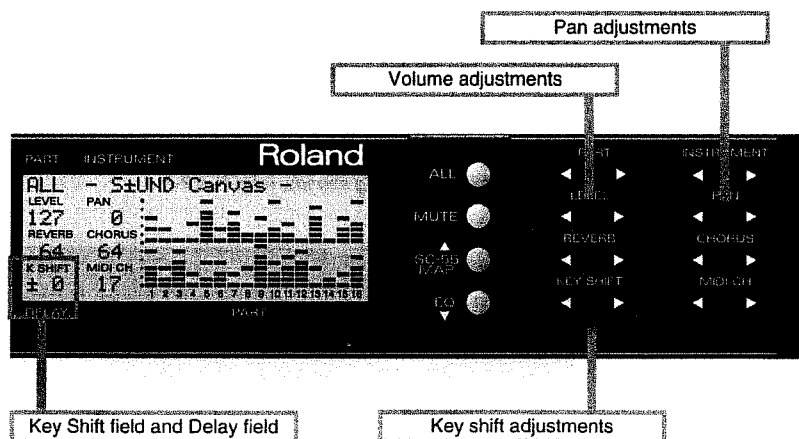

■ Apply effects to the sound

Effects allow you to electronically process the sound in various ways. The SC-88 provides 8 types of reverb, 8 types of chorus, and 10 types of delay effect. For each of these effects, you can specify parameters such as Character, Depth, Rate and Time, to get just the result you want ([p.3-2](#)).

● Adjust the amount of reverb

Reverb is an effect that adds spacious reverberance to the sound, simulating a performance in an acoustically live concert hall. Pressing REVERB [◀] decreases the reverb depth, and pressing REVERB [▶] increases the reverb depth.

● Adjust the amount of chorus

Chorus is an effect that adds depth and richness to the sound. Pressing CHORUS [◀] decreases the chorus depth, and pressing CHORUS [▶] increases the chorus depth.

● Adjust the amount of delay

Delay is an effect that delays the sound to create echoes. Also, you can add a short delay to the original sound to give depth and space to the sound. Pressing DELAY [◀] decreases the volume of the delayed sound, and pressing DELAY [▶] increases the volume of the delayed sound.

* The area of the screen where the Delay setting is displayed is shared with the Key Shift display. When the DELAY buttons are pressed the delay setting will be displayed, and when the KEY SHIFT buttons are pressed the key shift setting will be displayed. If the display indicates a +/- (plus or minus) value, the key shift setting is being displayed.

● Using the equalizer

The equalizer allows you to change the tonal character of the sound. Make equalizer settings, and then press the [EQ] button to turn the equalizer on or off.

* For details on using the equalizer, refer to [p.3-2](#).
* With the factory settings, equalizer gain is set at 0. This means that the equalizer will have no effect even if the EQ indicator is on.

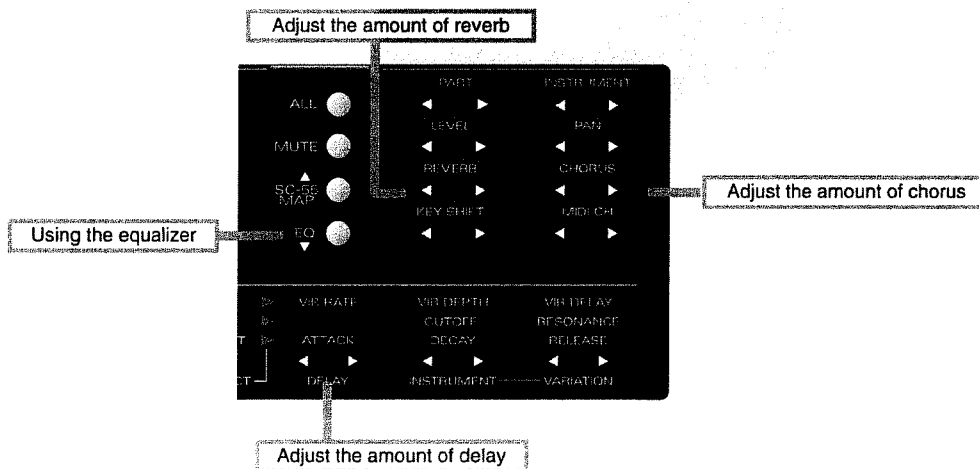

■ Tuning to other instruments (Tuning)

○ Master Tune (Master Tune) 415.3 — 466.2 Hz

When you are playing in an ensemble with other instruments or need to set the SC-88 to match the pitch of another instrument, adjust the Master Tune setting. The displayed value (e.g., 440.0 Hz) indicates the frequency of the A4 note's pitch (note number 69).

Tuning procedure

1. Press [ALL] to make the button indicator light.
2. Simultaneously press both the PART [◀] [▶] buttons.
3. Press [▲] or [▼] to select "M. Tune"

```
PART  INSTRUMENT
ALL  >M. Tune: 440.0
LEVEL PAN  :
1000  0 :
```

4. As you listen to the sound, use INSTRUMENT [◀] [▶] to adjust the pitch of the SC-88 to match the pitch of the other instrument.
Pressing [◀] will lower the pitch, and pressing [▶] will raise the pitch. The display will show the frequency of the pitch, so if you are tuning to a specific frequency you can visually check the desired value.
5. When you have made the desired setting, simultaneously press both the PART [◀] [▶] buttons.

* It is also possible to set the tuning independently of each Part (see p. 2-13).

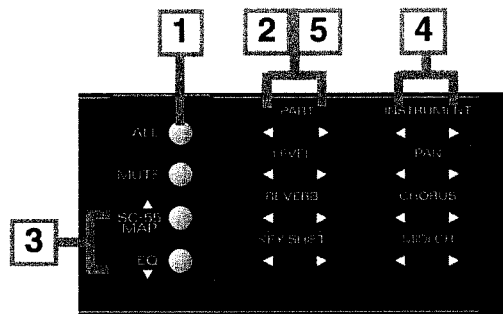

■ Headphones

Use headphones of 8 — 150 ohms impedance. Sound will be output from the audio output jacks even when headphones are connected.

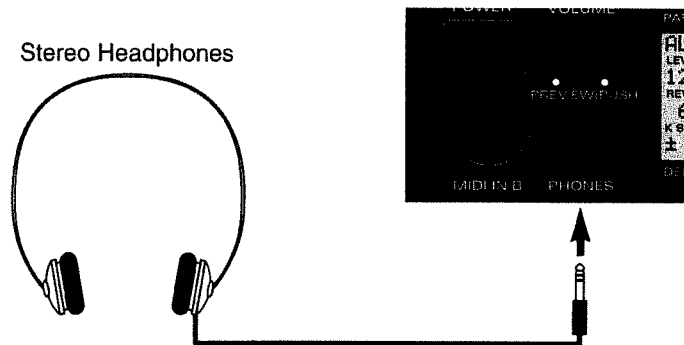

■ Audio output jacks / Audio input volume

You can connect the output jacks of other MIDI sound sources to these jacks. The audio signal that is input here will be mixed with the SC-88 sound and output from the audio output jacks.

If the signal input to the SC-88 is too large or too small, use the audio input volume knob to adjust it. If the input signal is too large, rotate the knob to the left to reduce the volume.

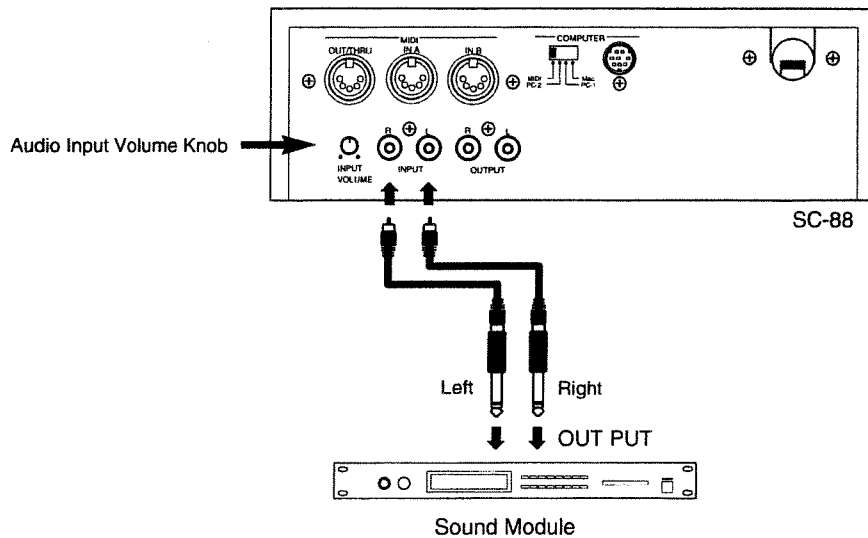

Chapter 2

Parts and parameters

■ Parts and sounds

The SC-88 is able to produce 32 different types of sound at once. An instrument such as the SC-88 that can simultaneously produce many sounds from a single unit is called a multi-timbral sound generator. A Timbre is an instrumental sound. Being able to simultaneously play 32 sounds means that you can use 32 different instruments at once. In other words, you can create an orchestra-like ensemble of 32 musical parts. In the SC-88, the sound selected for each Part is called an Instrument. (Instrument chart, p.7-10) You can assign the sounds you want to each of 32 Parts to create your own ensemble.

There are two types of Parts: Normal Parts and Drum Parts. We refer to this difference as the Part mode (see p.2-13). Normal Parts are used for playing melody or bass lines. Drum Parts are used for playing percussion instruments.

* For details about MIDI and Part Mode, refer to p.6-3, 2-13.

● Assigning a sound to a Part

1. Make sure that the [ALL] indicator is dark.

If it is lit, press the [ALL] button to turn it off.

2. Use the PART [◀] [▶] buttons to select the Part for which you want to specify a sound.

As you press the PART [◀] [▶] buttons, the screen display indicating the Part numbers will change "A01..A16 B01..B16". If you select the Drum Part, an "*" will be displayed in front of the Drum Set name.

* To switch between the A and B Parts, simultaneously press both [ALL] and PART [◀].

```

PART  INSTRUMENT
A10  026*TR-808/909
LEVEL PAN :
100  0  :
```

3. Use the INSTRUMENT [◀] [▶] buttons to select the sound (Instrument) for each Part.

If the SELECT indicator is dark, you can also use the INSTRUMENT [◀] [▶] buttons located in the lower right of the panel to select instruments.

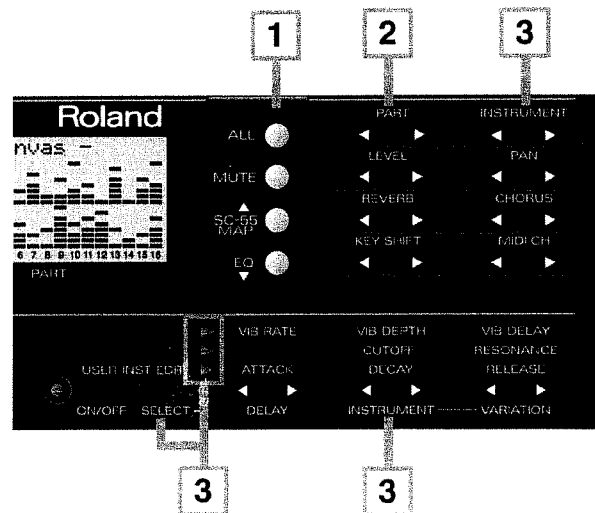

○ To select the same sounds as the SC-55/SC-55mk II

4. Press [SC-55 MAP], and the sound for that Part will be the same as the SC-55/55mk II.

At this time "" will be displayed in front of that Instrument name.

PART	INSTRUMENT
P01	001 "Piano 1
LEVEL	PAN :
100	0 :

5. Press the [ALL] button to make the [ALL] indicator light.

Now if you press the [SC-55 MAP] button to make the [SC-55 MAP] indicator light, the sounds of all Parts will be the same as the SC-55/55mkII. In this way, the [SC-55 MAP] button allows you to quickly and easily make the appropriate settings for playing back SC-55/55mkII song data.

* It is also possible to select the CM-64 Instrument layout (see p.4-14)

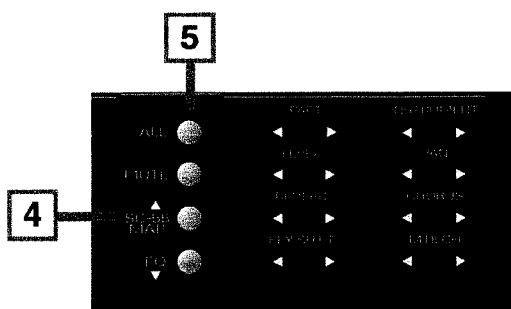

- * To select Part sounds or Drum Sets from another MIDI device, refer to p.5-8.
- * Some of the sounds in the SC-88 cannot be played above (or below) a certain pitch. This is because the sounds have been created with the pitch ranges of actual instruments in mind.
- * You can edit sounds to suit your taste and store them as User sounds. (see p.4-2)

● Selecting Variation sounds (1)

The SC-88 has two sound maps: a SC-88 map and a SC-55 map. In each map, sounds are classified either as Capital sounds or Variation sounds. The procedure explained on the previous page selects Capital sounds (128 sounds; Instrument list, *see* P.7-10). Here's how to select Variation sounds.

1. Make sure that the [ALL] indicator is dark. If it is lit, press the [ALL] button to turn it off.
2. Use the PART [◀] [▶] buttons to select the Part for which you want to choose a Variation sound.
3. Make sure that the SELECT indicator is dark. If it is lit, press the [SELECT] button to turn it off.
4. Press the VARIATION [▶] button and the variation sounds and variation numbers will be displayed.

Each time you press a VARIATION [◀] [▶] button the variation number will change, and a different variation sound will be selected. The variation number (000~) that is displayed at this 2 - 3time will change back to the Instrument number (001+) after a short time.

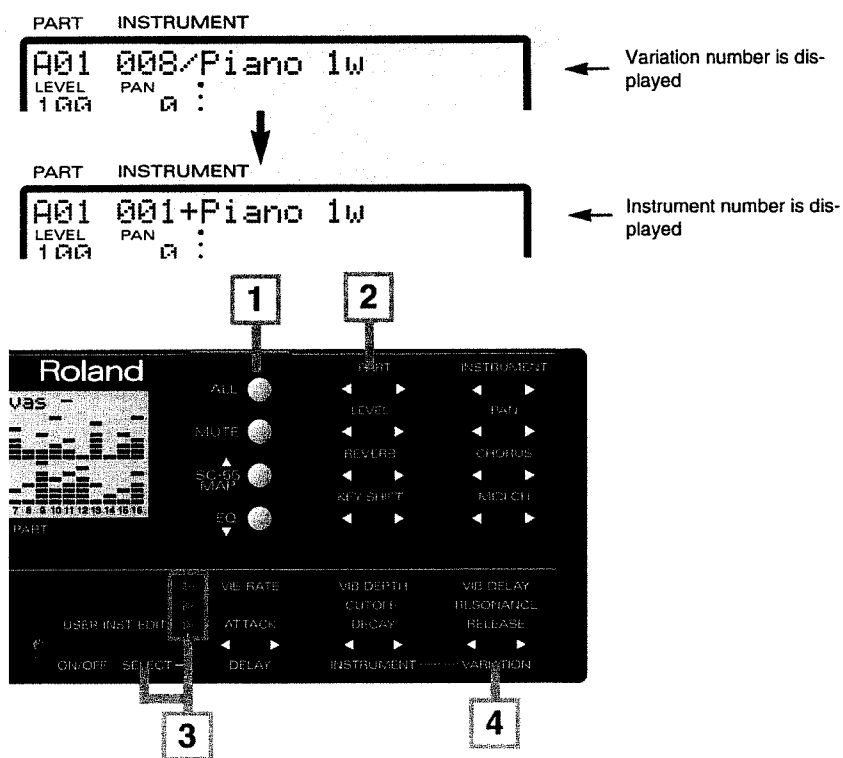

- * Some Variation numbers are not consecutive.
- * If the Part is set to a Drum Part (*see* 2-2, 2-13), the Drum Set will not change even if you press the Variation buttons. This is because Drum Sets do not have Variations.
- * Sounds compatible with the CM-64 are Variation sounds in the SC-55 map. Original sounds you create (*see* P.4-2) are Variation sounds in the SC-88 map. To select Variation sounds, use the following procedure.

A symbol will be displayed in front of the sound name to indicate the type of sounds you are selecting.

- blank Capital sounds (Variation number 000)
- "+" Variation sounds (Variation number 001 — 125)
- "" SC-55/55mk II sounds
- "#" CM-64 compatible sounds (Variation number 126, 127)

PART INSTRUMENT A01 001 Piano 1 LEVEL PAN : 100 0 :		← Capital sounds
PART INSTRUMENT A01+001 Piano 1w LEVEL PAN : 100 0 :		← Variation sounds (Instrument number is displayed)
PART INSTRUMENT A01 008 Piano 1w LEVEL PAN : 100 0 :		← Variation sounds (Variation number is displayed)
PART INSTRUMENT A01 001 "Piano 1 LEVEL PAN : 100 0 :		← SC-55/55mk II sounds
PART INSTRUMENT A01 001 #"Acou Piano 1 LEVEL PAN : 100 0 :		← CM-64 compatible sounds

● Reading the Instrument numbers and Variation numbers

Each sound (Instrument) of the SC-88 has two numbers; an Instrument number and a Variation number. Sounds with Variation number 000 are Capitals, and the sounds with numbers other than 000 are Variations.

In normal displays, the Instrument numbers will be displayed. The display screen on the SC-88 can show either the Instrument number or the Variation number, not both.

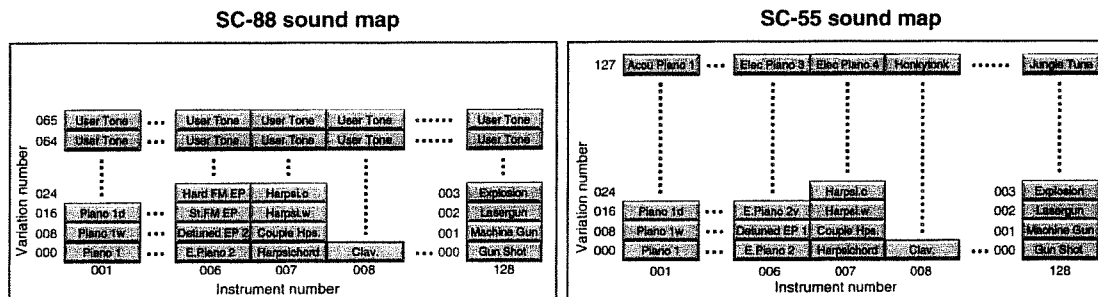

● Selecting sound variations (2)

As previously explained, the VARIATION buttons are an easy way to select Variation sounds. However in this case, the Variation number will change back to the Instrument number after a short time. (I.e, with this method of selecting sounds, the Variation number is not continuously displayed.) If you use the following procedure to change the display mode, you can have the Variation number displayed continuously as you select sounds.

1. When the power is turned on, the following display will appear.

The Instrument number is displayed.

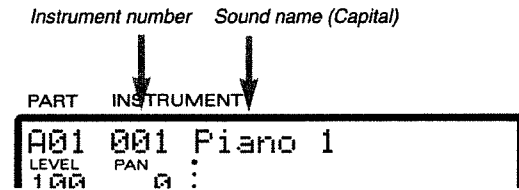

2. Simultaneously press both INSTRUMENT [◀] [▶] buttons to enter Variation select mode.

The Variation number and a "/" symbol will be displayed in front of the Instrument name.

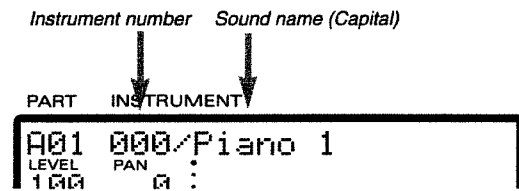

3. Press INSTRUMENT [▶] to change the Variation number.

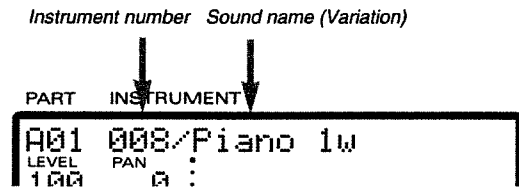

4. To exit Variation select mode, simultaneously press both the INSTRUMENT [◀] [▶] buttons. You will return to normal mode (the Instrument number is displayed).

The display will change from the Variation number to the Instrument number.

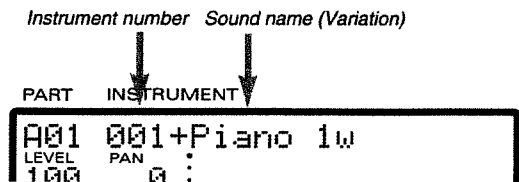

● Part Channels

To each of the SC-88's 32 Parts, there is assigned an instrument and also a Channel. Channels are a concept used in MIDI to distinguish notes that should be played by different instruments in an ensemble. Normally, there is no need to change the channel of a Part when using the SC-88. However it may sometimes be interesting to set two Parts to the same channel so that two sounds will simultaneously play the same musical line. To change the MIDI channel of a Part, use the following procedure.

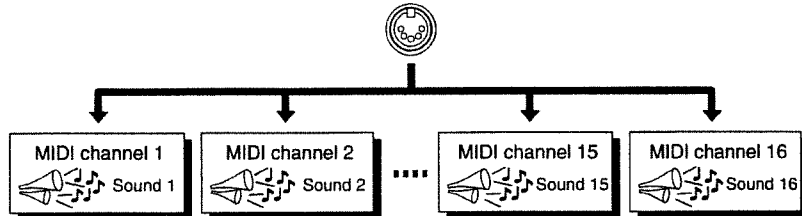

Procedure

1. Make sure that the [ALL] indicator is dark.

If it is lit, press the [ALL] button to turn it off.

* If you operate the MIDI CH [◀] [▶] buttons while the [ALL] indicator is lit, the Device ID Number (see p.6-9) will be changed. Be careful.

2. Use the PART [◀] [▶] buttons to select the Part whose channel you wish to change.

When you press the PART [◀] [▶] buttons, the Part number will change as "A01 . . A16 B01 . . B16". If you select a Drum Part, a "*" mark will appear in front of the Drum Set name.

3. Use the MIDI CH [◀] [▶] buttons to set the MIDI channel of the Part.

When you press the MIDI CH [◀] [▶] buttons, the MIDI channel will change as "A01 . . A16 A-- B01 . . B16 B--". Select the desired MIDI channel. Parts for which you select "A-- , B--" will ignore all MIDI messages except Exclusive messages.

* To switch between the A and B, simultaneously press both KEY SHIFT [▶] and MIDI CH [◀]

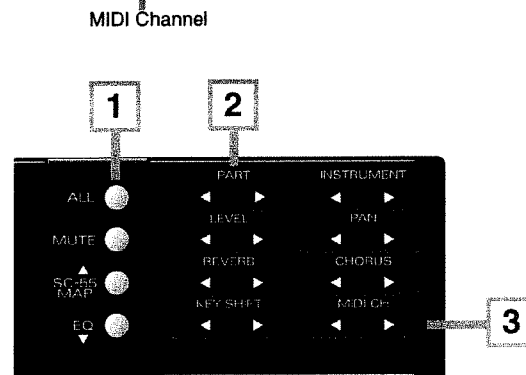
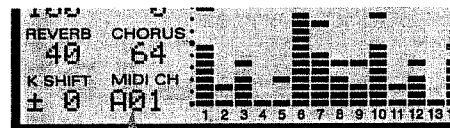

● Which MIDI IN will be used by each Part?

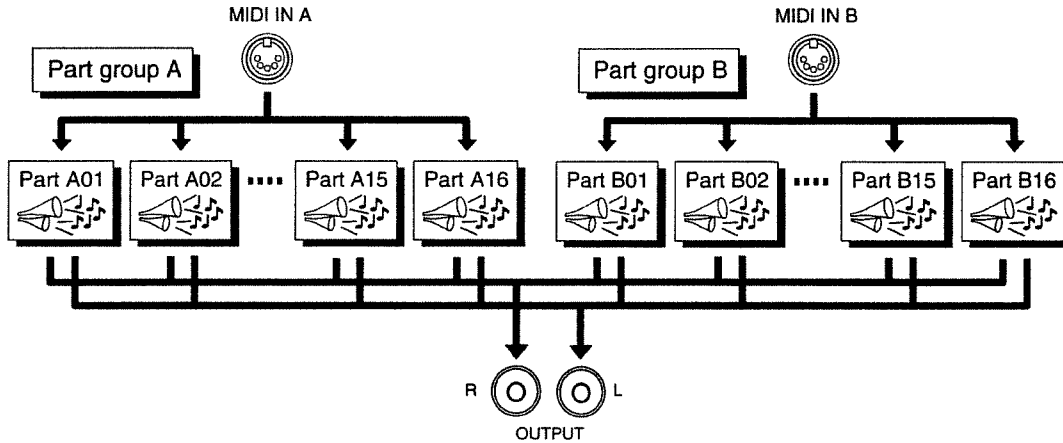

The SC-88 has two MIDI IN jacks. This is because since there are only 16 MIDI channels, it is necessary to have two MIDI jacks in order to play 32 Parts.

Parts are classified into Group A (A01 — A16) and Group B (B01 — B16), with sixteen in each group. The MIDI channel assigned to each Part is also displayed in two groups as A01 — A16 or B01 — B16. With the factory settings, groups A and B correspond to the SC-88's two MIDI IN jacks A and B. In other words, MIDI messages received at MIDI IN A are sent to the group A Parts, and MIDI messages received at MIDI IN B are sent to the group B Parts. For example, a MIDI message on channel 5 received at MIDI IN B will sound Part B05 (with the factory settings).

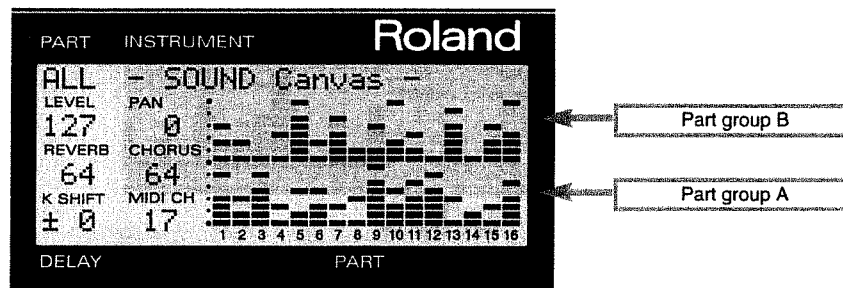

* Be aware that the way in which the data is sent from the two MIDI IN jacks to the various Parts will depend on the setting of the System parameter Receive Connection (Input Modes p.6-12). Also, Exclusive messages received at MIDI IN A can be passed on to Parts of group B, depending on the specified address. (* p.7-26, 7-29)

If the [ALL] button has been pressed to turn on the [ALL] indicator, the volume levels of the 32 Parts will be graphically displayed as shown below when the SC-88 is played. This graphic display allows you to monitor the reception for each Part.



● How simultaneous note numbers and Voices are related

The sounds of the SC-88 consist of units called "Voices". There is a limit to how many of these "Voices" can sound at once, and in the case of the SC-88, up to 64 simultaneous voices can be used. Some sounds (Instruments) use 1 voice and others use 2 voices (Instrument table, p.7-10). The main reason that some sounds use 2 voices is to allow different timbres to be produced by different velocity values.

If more than 64 voices are used at once, later-sounded notes will be given priority, and notes sounded previously will be turned off starting from the oldest. If you use only single-voice instruments, you will be able to play 64 notes simultaneously, but if some of the instruments are 2-voice, you will be able to play less than 64 simultaneous notes. Even if a MIDI Note Off message ( p.6-4) is received, voices will be used for as long as the sound is heard. Be aware of this especially in the case of sound with a long release ( p.2-20).

* *If song data created with 64 voice playback in mind is played back on a sound source with fewer voices, some notes will drop out, and the musical result will not be as it should. The SC-55 has 24 voices, and the SC-55mkII has 28 voices.*

■ Part parameters for performance

These parameters determine how each Part behaves when it receives MIDI messages. The way in which the sound changes in response to messages such as velocity, pitch bend, modulation and aftertouch will be determined by the settings of these parameters.

● Parameters that can be set directly using the buttons

LEVEL [◀] [▶]	: set the volume of each Part
PAN [◀] [▶]	: set the pan of each Part
KEY SHIFT [◀] [▶]	: transpose each Part
[MUTE]	: mute each Part (Part Mute)
[ALL]*[MUTE]	: monitor each Part (Part Monitor)
[SC-55 MAP]	: set each Part to the same sounds as the SC-55/mk II
[EQ]	: apply equalization to each Part

* Indicates that both buttons must be pressed simultaneously.

● Procedure

1. Make sure that the [ALL] indicator is dark. If it is lit, press the [ALL] button to turn it off.
** If you wish to change the volume (for example) of all Parts simultaneously, press the [ALL] button to make the indicator light, and continue the following procedure. (p.2-21)*
2. Use the PART [◀] [▶] buttons to select the Part whose setting you wish to change.
3. Use the parameter buttons on the front panel to change the setting. The setting will be displayed in the appropriate part of the screen.
4. When you press the LEVEL, PAN and KEY SHIFT [◀] [▶] buttons simultaneously, the current setting will be shown graphically on the screen.

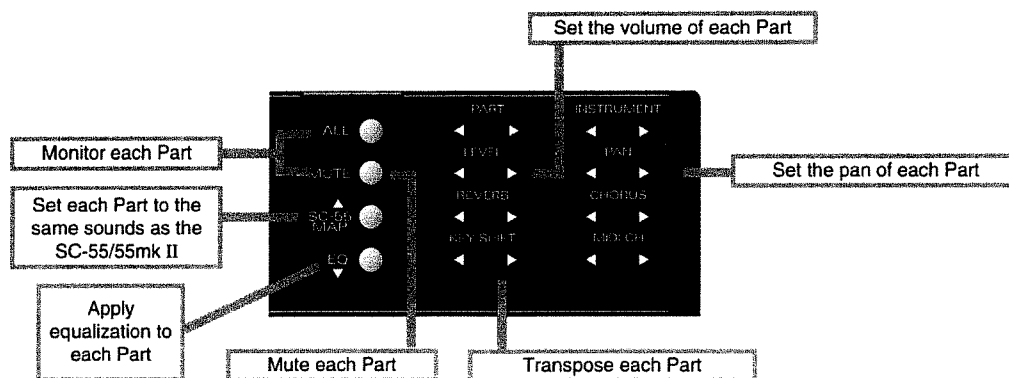

● Parameters that must be selected from the menu

The following parameters can be selected.

Part Mode	(Part Mode)
M/P Mode	(Mono/Poly Mode)
Fine Tune	(Fine Tune)
Rx Bank Sel	(Bank Select Receive Switch)
Rx NRPN	(NRPN Receive switch)
Bend Range	(Bend Range)
Mod.Depth	(Modulation Depth Sensitivity)
K.Range L	(Keyboard Range Low)
K.Range H	(Keyboard Range High)
Velo Depth	(Velocity Sense Depth)
Velo Offset	(Velocity Sense Offset)
CAf LFO Rate	(Channel Aftertouch Rate)
CAf LFO Pich	(Channel Aftertouch Pitch Depth)
CAf LFO TVF	(Channel Aftertouch TVF Depth)
CAf LFO TVA	(Channel Aftertouch TVA Depth)

● Procedure

1. **Make sure that the [ALL] indicator is dark.**
If it is lit, press the [ALL] button to turn it off.
2. **Simultaneously press both the PART [◀] [▶] buttons.**
3. **Use the PART [◀] [▶] buttons to select the Part whose settings you wish to modify.**
4. **Press [▲] or [▼] to select the parameter you wish to modify.**

```

PART  INSTRUMENT
A01  >Part Mode: Norm
LEVEL PAN  :
1000  0  :
```

5. **Use the INSTRUMENT [◀] [▶] buttons to set the value.**
6. **When you finish making settings, simultaneously press both the PART [◀] [▶] buttons to end the procedure.**

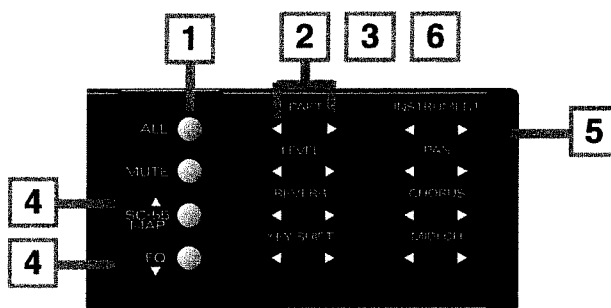

● What each parameter does

○ LEVEL (Volume level): 0 — 127

This parameter adjusts the volume of each Part. Higher values result in a louder sound.

○ PAN (Panning): Rnd, L63 — 0 — R63

Pan refers to the position in the stereo field. For example, you might place the drum set and bass in the center, the guitar at the right, and the keyboard at the left. To place the sound in the center, set this value to 0. As the L-number increases the sound will move further to the left, and as the R-number increases the sound will move further to the right. With a setting of "Rnd" (random), each note will be placed at an unpredictable location.

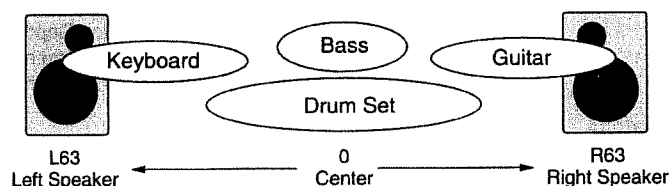

- * In the case of a Drum Set, the pan position has been fixed for each percussion instrument. Adjusting the Pan of a Drum Set will shift the overall set to left or right.
- * For some instruments, some sound may be heard from the opposite speaker even if Pan has been set fully left or right.
- * If your amp/speaker system is mono, Pan will have no effect.

○ KEY SHIFT: -24 — ± 0 — +24: semitone steps, 2 octaves

This parameter transposes the Part. As the value increases (decreases) the pitch will rise (fall) in steps of a semitone. 12 steps make a difference of 1 octave. With a setting of 0 the pitch will not be affected.

○ MUTE (Part Mute): On/Off

This function allows you to mute the sound of a specific Part so that it will not be heard. When the [MUTE] button is pressed to turn on the indicator, Part Mute will be turned on. When playing back a recorded ensemble from a sequencer etc., it is sometimes convenient to mute one of the Parts and play the missing part yourself. The lowest dot on the bar display indicates the mute on/off status of each Part. The dot will be off for Parts whose Part Mute is turned on.

- * If All Mute (*see* p.2-22) is on, the lowest dot in the bar display will be off for all Parts, regardless of their Part Mute on/off setting.
- * When a GM System On or GS Reset message (*see* p.6-8) is received, muting will be canceled. If you do not wish mute to be canceled, turn on Mute Lock (*see* p.6-14).

○ SC-55 Map (Part SC-55 MAP): On / Off

When the [SC-55 MAP] button is pressed to turn on the indicator, the sound of the currently selected Part will change to be the same as the SC-55/55mk II.

○ Part Monitor: On/Off

Part Monitor can be turned on when you want to listen to only one or more Parts that you select. This feature conveniently allows you to listen to only the instruments you want to hear during sequenced playback. To turn it ON, simultaneously press both [ALL] and [MUTE]. The indicator on MUTE will blink on and off while the feature is on.

- * While you have the Part Monitor on, you can press INSTRUMENT [▶] (in the panel's bottom row) to listen to some other Part you want to hear. The volume ratio of some other parts is displayed in the MIDI CH column.
- * With Part Monitor on, you can add extra Parts that you want to monitor by using PART [◀] [▶] to select Parts, then pressing VARIATION [▶]. Press VARIATION [◀] to cancel whatever choices you have made.



○ Part EQ: On/Off

The Part EQ function applies equalization to the Parts for which the [EQ] indicator is lit. When you press the [EQ] button to turn off the indicator, equalization will not be applied.

- * For details on equalizer settings refer to p.3-2.
- * With the initial settings, equalizer gain is set at 0. This means that the equalizer will have no effect even if the EQ indicator is on.

○ Part Mode: Norm/Drum1/Drum2

For Parts which are playing conventional instrument sounds, select Norm (Normal mode). For Parts which are playing percussion or drums, select Drum1 or Drum2. Drum Parts play a different sound (Instrument) for each different MIDI note number. In other words, a single Part can play many different percussion instrument sounds (List of drum sets p.7-16).

The Drum1 and Drum2 Parts allow you to simultaneously use two drum sets. For example if Drum Parts are set as shown below, when you change the STANDARD1 drum set of Part A10 to the TR-808/909Set, the selection for Part A12 will also change to TR-808Set. For details on how to assign a drum set to a Part, refer to p.2-2.

Part name	(Part Mode)	Name of drum set
Part A10	(Drum1) :	STANDARD
Part A11	(Drum2) :	JAZZ
Part A12	(Drum1) :	STANDARD

○ M/P Mode (Mono/Poly Mode): Mono/Poly

If a Part is set to Mono (Mono Mode), that Part will play only one note at a time. It is effective to select Mono Mode for parts that are playing a naturally monophonic instrument such as a trumpet or sax. Select Poly Mode for Parts that are playing chords.

- * For a Drum Set, changing the Mono/Poly Mode setting will not affect the sound.

○ Fine Tune: -100.0 — +100.0 cent

Use this parameter when you wish to make fine adjustments to the tuning of a Part. Positive (+) settings will raise the pitch, and negative (-) settings will lower the pitch. If two or more Parts are set to the same MIDI channel and the same sound, you can spread their Fine Tuning settings apart to add rich depth and breath to the sound.

- * To adjust the pitch of all Parts, use the Master Tune parameter (* p.1-8).
- * To transposes the Part, use the KEY SHIFT parameter (* p.2-10).

Rx Bank Sel (Bank Select Receive Switch): On/Off

Rx NRPN (NRPN Receive Switch): On/Off

For details of these two parameters, refer to p.6-16.

Bend Range: \pm 0 — +24

When you move the pitch bend lever or pitch bend wheel of a MIDI keyboard, pitch bend messages are transmitted to modify the pitch. The Bend Range setting determines the maximum range of pitch change that will result from incoming pitch bend messages. At a setting of 12, the pitch can be modified through a range of 1 octave. At a setting of 24, the pitch can be modified through a range of 2 octaves. At a setting of 0, pitch bend messages will have no effect.

Mod. Depth (Modulation Depth): 0 — 127

When you move the modulation lever or modulation wheel of a MIDI keyboard, modulation messages are transmitted to control effects such as vibrato (with the factory settings). Vibrato is an effect that adds expression to the sound by cyclically varying the pitch. The Modulation Depth setting determines the maximum effect of incoming modulation messages. Higher values will allow more modulation to be applied. At a setting of 0, modulation messages will have no effect.

K. board Range L (Key Range Low): C-1 — G9

K. board Range H (Key Range High): C-1 — G9

The Key Range parameters determine the pitch range over which the instrument will be sounded. Key Range Low (the lowest note) and Key Range High (the highest) note will determine the range of notes that will sound. These values are displayed as key names. You can specify a value between C-1 and G9 (0 — 127), and middle C is C4 (60).

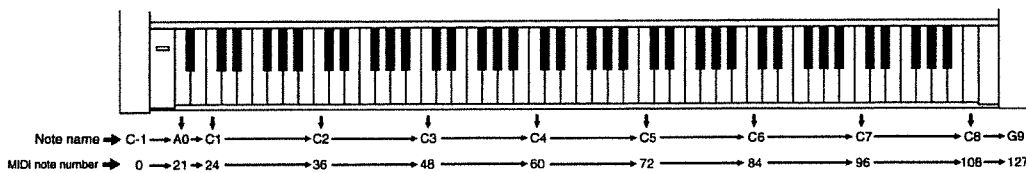

For example, if you assign two Parts to the same MIDI channel and set the Key Range of one to C-1 — B3 and the other to C4 — G9. Then you could assign different sounds to each Part, and play two different sounds on either side of C4. Or, you could set the keyboard ranges of two Parts to overlap, and layer the two sounds.

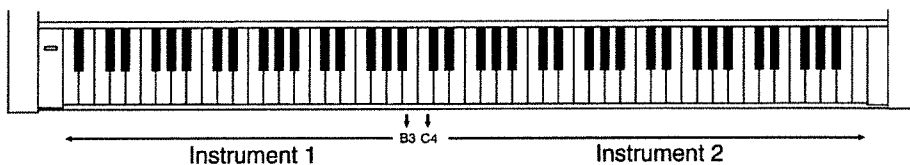

○ **Velocity Sens Depth (Velocity Sensitivity Depth): 0 — 127**

○ **Velocity Sens Offset (Velocity Sensitivity Offset): 0 — 127**

The force with which you play a note on MIDI keyboard is transmitted as MIDI Velocity data. Strongly played notes will have a higher velocity value. The Velocity Sens Depth and Velocity Sens Offset parameters determine the relation between the force of your keyboard playing and the loudness of the sound that results.

If Velocity Sens Depth is increased, small differences in your playing dynamics will make a large difference in the loudness of the sound (Fig.3). If Velocity Sens Depth is decreased, even large differences in your playing dynamics will make only a small difference in the loudness of the sound (Fig.2).

If Velocity Sens Offset is set higher than 64, even softly played notes (i.e., notes with a low velocity) will be sounded loudly (Fig.5). If Velocity Sens Offset is set lower than 64, even strongly played notes (i.e., notes with a high velocity) will be sounded softly (Fig.4).

* For some settings, there may be no sound. If so, increase Velocity Sens Depth or Velocity Sens Offset.

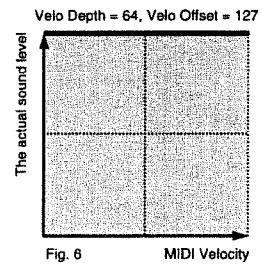
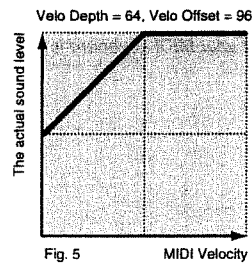
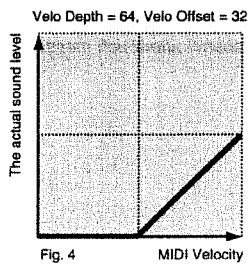
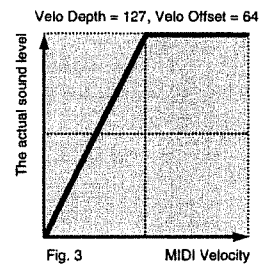
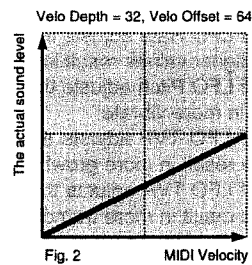
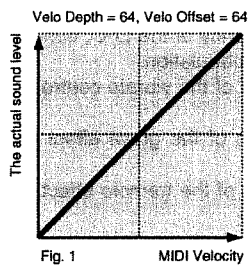

-
- **CAf LFO Rate (Channel Aftertouch Rate): -64 — +63**
 - **CAf LFO Pitch (Channel Aftertouch Pitch Depth): 0 — 127**
 - **CAf LFO TVF (Channel Aftertouch TVF Depth): 0 — 127**
 - **CAf LFO TVA (Channel Aftertouch TVA Depth): 0 — 127**

On some MIDI keyboards, pressing down on the keyboard after playing a note causes a message called Aftertouch to be transmitted. (Channel Aftertouch is also called Channel Pressure.) The SC-88 can respond to incoming aftertouch messages by modifying the way in which pitch, timbre or volume are cyclically changed by the LFO to add expression to the sound.

When the LFO modulates the pitch, the result is vibrato (cyclical variation in pitch). When the LFO modulates the TVF, the result is a growl effect (cyclic variation in timbre). When the LFO modulates the TVA, the result is tremolo (cyclic variation in volume).

TVF : Time Variant Filter
TVA : Time Variant Amplifier
LFO : Low Frequency Oscillator

CAf LFO Rate adjusts the frequency of the LFO, controlling the speed of the modulation. Higher values result in faster modulation.

CAf LFO Pitch adjusts the depth of the vibrato controlled by aftertouch. Higher values result in more vibrato.

CAf LFO TVF adjusts the depth of the growl effect controlled by aftertouch. Higher values result in more growl.

CAf LFO TVA adjusts the depth of the tremolo effect controlled by aftertouch. Higher values result in more tremolo.

If each of these values are set to 0, there will be no effect.

* *With the factory settings, incoming aftertouch messages will have no effect. If you want aftertouch to have an effect, you must modify the above parameters. Also you need to make sure that your MIDI keyboard is able to transmit aftertouch messages.*

■ Part parameters for sound editing

On the SC-88, you can modify the values of a variety of parameters in order to create the sound most suitable for your playing. A "parameter" is something that affects the sound. The process of modifying parameter values is called "editing." Sound parameters affect the volume, timbre and pitch of the sound.

- Parameters for Vibrato, Filter, and Envelope are distinguished from the Part parameters of the same name, and can also be set for sounds (Instruments). Sounds created in this way are called User Sounds, and are stored separately from the SC-88 map (see p.4-2).

You can set the following parameters.

Vibrato	Filter	Envelope
Vibrato Rate	Cutoff Frequency	Attack Time
Vibrato Depth	Resonance	Decay Time
Vibrato Delay		Release Time

● Procedure

- 1. Make sure that the [ALL] indicator is dark.**
If it is lit, press the [ALL] button to turn it off.
- 2. Use the PART [◀] [▶] buttons to select a Part.**
- 3. Press the [SELECT] button to select the parameter (vibrato, filter, envelope) you wish to edit, and use the corresponding set of [◀] [▶] buttons to modify the value.**
- 4. Simultaneously pressing both [◀] [▶] buttons used to set Vibrato, Filter or Envelope will cause the setting status of that parameter to appear graphically in the display.**

Simultaneously press both buttons again, and the previous display will reappear.

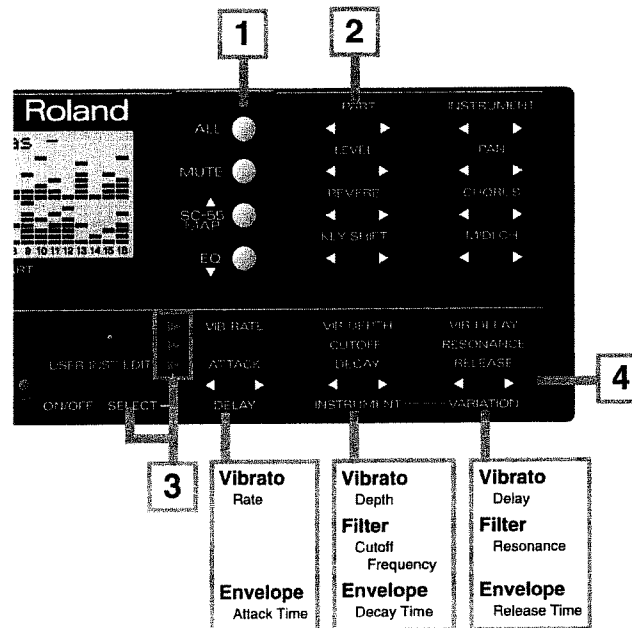

● Editing display

(Example) Vibrato editing display

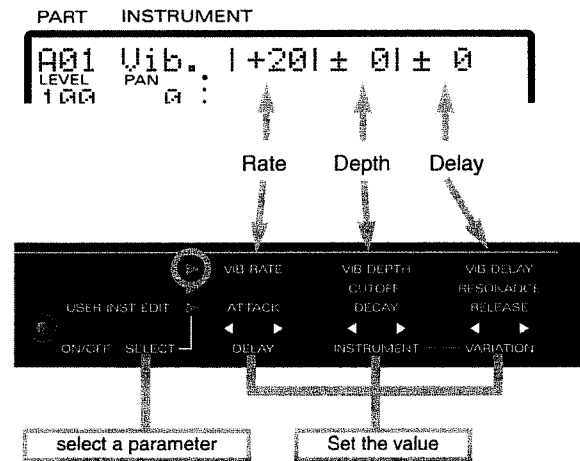

■ What each parameter does

On the SC-88, parameter settings are made for each Part. In other words, parameter values belong to Parts, and not to sounds (Instruments). For example if you set Vibrato Rate to +20 and then select a different sound for that Part, the Vibrato Rate of +20 will apply to the newly selected sound (not the initial value of ± 0). In this way, parameters belonging to Parts are called Part Parameters.

* Parameters such as Vibrato, Filter and Envelope are separate from the Part parameters of the same name, and can be set not only for Parts, but also for sounds (Instruments). Sounds you create by modifying these parameters are called User sounds, and can be stored in the SC-88 sound map memory area (see p.4-3).

Vibrato

Vibrato is an effect created by modulating the pitch. Applying vibrato makes the sound more expressive.

○ Vibrato Rate: -64 — +63

This parameter adjusts the speed (frequency) of the pitch modulation. Positive (+) settings make the pitch modulation faster, and negative (-) settings make it slower.

○ Vibrato Depth: -64 — +63

This parameter adjusts the depth of the pitch modulation. Positive (+) settings make the pitch modulation deeper, and negative (-) settings make it shallower.

○ Vibrato Delay: -64 — +63

This parameter adjusts the time required for the vibrato effect to begin. Positive (+) settings increase the time before vibrato will begin, and negative settings shorten the time.

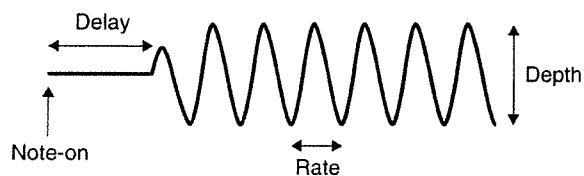

Filter

By modifying the filter settings, you can control the timbre (tone) of the sound. The type of filters in the SC-88 are called Low Pass Filters, and allow only frequencies lower than a specified frequency to pass. This frequency is called the Cutoff Frequency. By modifying the setting of the Cutoff Frequency you can make the sound brighter or darker. The Cutoff Frequency can change over time, controlled by the "envelope" (see p.2-20). By adjusting the filter and envelope settings, you can create sounds that have movement and expression.

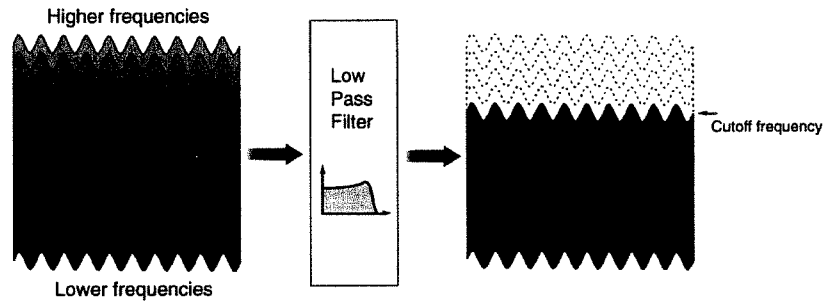

○ Cutoff Freq (Cutoff Frequency): -63 — +63

Positive settings of Cutoff Freq will raise the cutoff frequency. Negative settings will lower the cutoff frequency. As you set this value higher in the positive direction, more overtones will be allowed to pass, and the sound will become harder (brighter). The further this value is set in the negative direction, the fewer overtones will be allowed to pass, and the sound will become softer (darker).

* For some sounds, positive (+) settings of Cutoff Freq will cause no noticeable change in the sound.

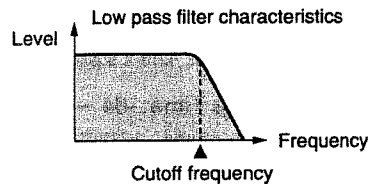

○ Resonance: -64 — +63

When the Resonance value is increased, the overtones in the area of the cutoff frequency will be emphasized, creating a sound with a strong character.

* For some sounds, negative (-) settings of Resonance will cause no noticeable change in the sound.

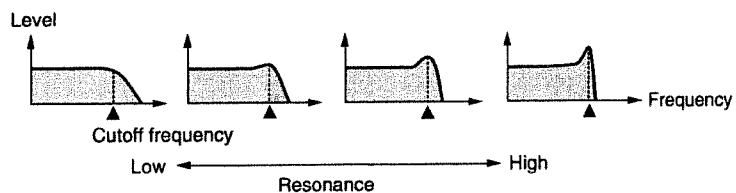

Envelope

The volume of an instrument changes with time, from the moment the note begins to sound to when it disappears. This change can be indicated on a graph as shown in the following diagram. This shape is unique to each instrument, and is an important element in how we distinguish sounds we hear. This shape is called the "envelope." The envelopes of musical instrument sounds can change depending on how the instrument is played. For example if a trumpet is played sharply and strongly, the attack will be quick and the sound will be sharp. But if a trumpet is played lightly and softly, the attack will be softer. In order to adjust the attack of a sound, we can modify the Attack Time of the envelope. By modifying the values of the envelope we can simulate the characteristics of many different instruments.

The envelope shape that we create in this way will also affect the way in which the cutoff frequency changes. If the cutoff frequency had been lowered, it will rise as the envelope rises, and will fall as the envelope falls.

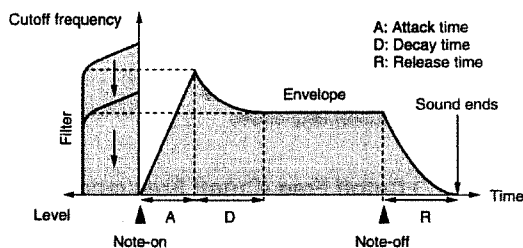

○ Attack Time: -64 — +63

This parameter adjusts the sharpness of the beginning of the sound.

○ Decay Time: -64 — +63

This parameter adjusts the time over which the sound will fall from the highest point of the attack down to the sustain level (Fig.1).

* Some sounds have a sustain level of 0 (Fig.2). Piano and guitar sounds are in this category.

○ Release Time: -64 — +63

This parameter adjusts the time over which the sound will decay after the note is released until it is no longer heard. The cutoff frequency will also fall according to this.

* For some sound, modifying the various Time settings of the envelope will cause no noticeable change in the sound.

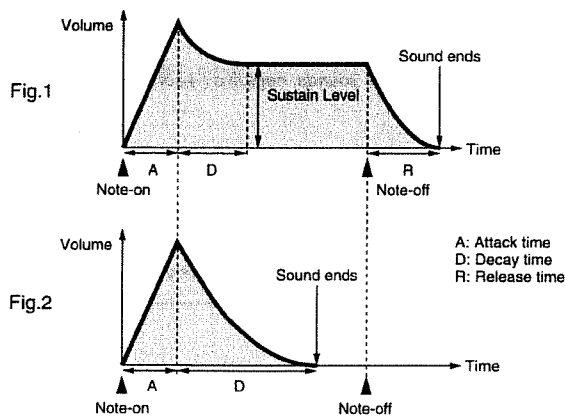

■ Setting parameters common to all Parts

Here's how to make settings for parameters that are common to all Parts.
This procedure allows you to set the following parameters.

LEVEL [◀] [▶]	: set the volume of all Parts
PAN [◀] [▶]	: set the pan of all Parts
KEY SHIFT [◀] [▶]	: transpose all Parts
[MUTE]	: mute all Parts (All Mute)
[SC-55 MAP]	: set the sounds of all Parts to match the SC-55/55mk II
[EQ]	: apply equalization to all Parts

* All Mute setting will be reset to their previous condition when [MUTE], is pressed.

● Procedure

1. Make sure that the [ALL] indicator is lit. If it is dark, press the [ALL] button to turn it on.

* If you wish to make settings independently for each Part, press the [ALL] button to turn off the indicator, and use the following procedure. (☞ p.2-10)

2. Use the front panel parameter buttons to make settings.
3. With the LEVEL, PAN and KEY SHIFT buttons, you can simultaneously press both [◀] [▶] buttons to graphically display the current setting on the screen. If you simultaneously press them once again, the previous screen will reappear.

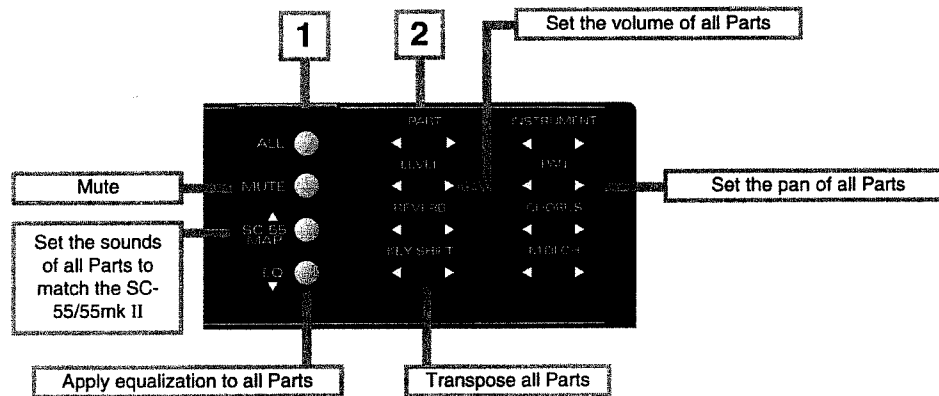

* For applying Chorus, Reverb and Delay to all Parts, refer to p.3-1

● How each parameter works

- * The settings made here apply to all Parts (when the [ALL] indicator is lit). If you wish to make settings independently for each Part, use the procedure of p.2-10.

○ LEVEL (Master Volume level): 0 — 127

This parameter adjusts the volume of all the Parts. As the displayed value increases, the volume will increase. The basic volume level of the entire SC-88 is adjusted by the Volume knob. If the volume knob is at minimum position, there will be no sound even if you increase this parameter.

○ PAN (Master Pan): L63 — 0 — R63

This parameter sets the Pan (stereo position) for all the Parts. As the displayed L value increases the sound will move further left, and as the R value increases the sound will move further right.

- * For some instruments, a bit of sound may be heard from the opposite speaker even if Pan has been set fully left or right.
- * If you are listening to the SC-88 in mono, Pan settings will have no effect.

○ KEY SHIFT (Master Key Shift): -24 — ± 0 — +24 semitone steps, 2 octaves

Key Shift adjusts the pitch of the sound in semitone steps. For example if you were playing back song data from a sequencer, you could use the Key Shift parameter to change the key of the song without changing the sequencer settings. Or, if you are singing along with sequence data, you can adjust Key Shift to move the song to the key most comfortable for your voice. As the displayed value rises (falls) one step, the pitch will rise (fall) one semitone. This means that 12 steps equal one octave.

- * Even if you adjust Key Shift for all Parts, the pitch of the Drum Part will not be affected.

○ MUTE (All Mute): On/Off

If you press the [MUTE] button to turn the indicator on, All Mute will be on, and the sound of all Parts will be muted.

- * Mute can also be set independently for each Part ([see](#) p.2-10).
- * When a GM System On or GS Reset message ([see](#) p.6-8) is received, muting will be canceled. If you do not wish mute to be canceled, turn on Mute Lock ([see](#) p.6-14).
- * When All Mute is turned on, each of the lowest dots in the bar display will be turned off.

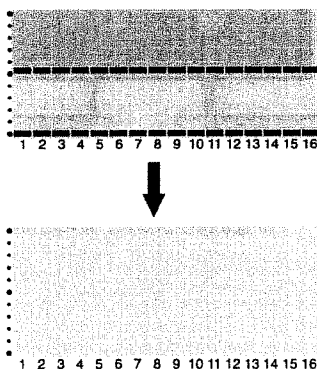

○ ALL SC-55 MAP: On/Off

If you press the [SC-55 MAP] button to make the indicator light, the sounds of all Parts will be set to the same sounds as the SC-55.

The [SC-55 MAP] button provides one-touch preparation for playing back SC-55/55mkII performance data.

- * It is also possible to turn the SC-55 map on/off for individual Parts (*see* p.2-10).
- * All the sounds for all Parts can be arranged so they use the SC-88 Map by holding down [SELECT] while you press [SC-55 MAP] (when the [ALL] indicator is lit). At this time, [SC-55 MAP] indicator blinks.

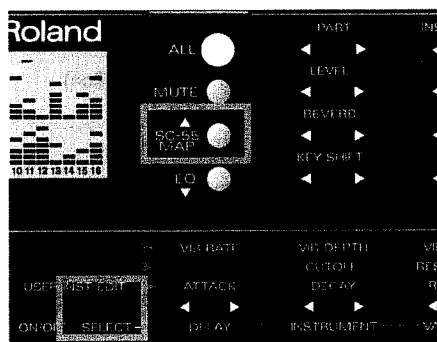

○ ALL EQ: On/Off

If you press the [EQ] button to make the indicator light, the equalizer (*see* p.3-2) will be applied to the sound of all Parts. If you press the [EQ] button once again to turn off the indicator, the equalizer will be turned off.

- * Equalizer on/off can also be set for individual Parts (*see* p.2-10).
- * For the procedure of making Equalizer settings, refer to p.3-2.
- * If ALL EQ is turned off, the equalizer will not be applied even if the Part EQ (*see* p.2-10) is turned on.
Even if Master EQ is on, the equalizer will have no effect if the EQ is turned off for each Part (*see* p.2-13).
- * With the factory settings, equalizer gain is set at 0. This means that the equalizer will have no effect even if the Master EQ indicator is on.

■ System parameter settings

This section explains how to make settings for parameters that affect the entire SC-88. These parameters are called System parameters.

System parameters are as follows.

Prevw Note	(Preview Note Name)
Prevw Velo	(Preview Velocity)
Display	(Display Types)
Peak Hold	(Peak Hold)
LCD Contrast	(LCD Contrast)
Backup	(Backup Switch)
IN B Sel.	(IN B Select)
OUT/THRU	(OUT/THRU Select)
In Mode	(Input Mode)
Rx Sys Mode	(System Mode set receive switch)

● Procedure

1. Simultaneously press [▲] and [▼].
2. Press either [▲] or [▼] to select the parameter you wish to set.

```
PART  INSTRUMENT
A01  %Prevw Note: A4
LEVEL PAN  :
100  a :
```

* "%" indicates a parameter that affects the entire SC-88 (a System parameter).

3. Use the INSTRUMENT [◀] [▶] buttons to set the value.
4. When you finish making settings, simultaneously press the [▲] and [▼] buttons to exit the procedure.

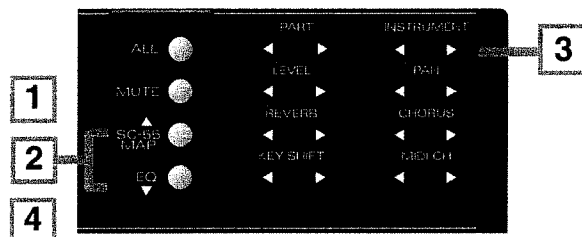

● How each System parameter works

○ **Prevw Note (Preview Note): C-1 — G9**

When you press the PREVIEW knob, the instrument shown in the display will sound. The Prevw Note parameter determines the note that will be sounded at this time. The A note in the center of the keyboard is A4.

* If you have set Key Shift, the pitch will be shifted (*see* p.2-10, 21).

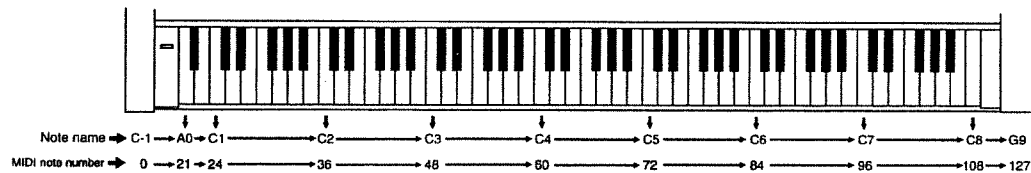
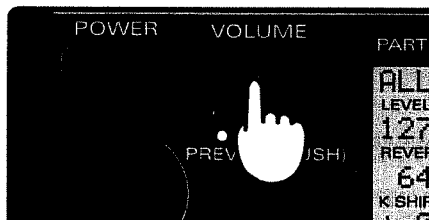

○ **Prevw Velo (Preview Velocity): 0 — 127**

This sets the velocity of the note that sounds when you press the PREVIEW knob. Normally, higher velocities result in louder sound. (*see* p.2-15 Velocity Sensitivity, etc.)

○ **Backup (Backup Switch): On/Off**

When the power is turned off, the SC-88 preserves (backs up) the settings which were made, and when the power is turned on again, these settings will reappear in the display. If the Backup Switch is turned off, the data will not be preserved.

* Even if the Backup Switch is off, the System function settings (*see* p.2-24) will be preserved.

○ **Display: Type1 — Type8**

This parameter allows you to select one of the following 8 types of volume level display.

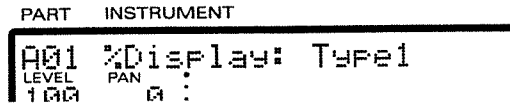

Type 1 : Bar display (factory preset)

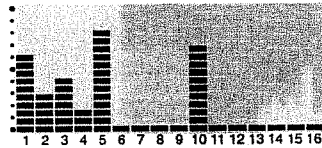

Type 5 : Reverse 1

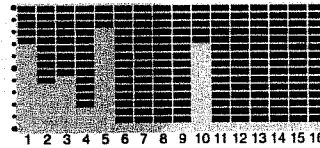

Type 2 : Single segment display

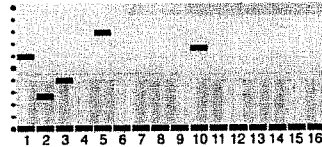

Type 6 : Reverse 2

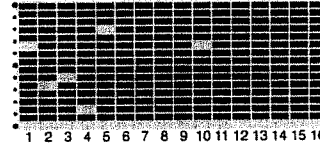

Type 3 : Top to bottom bar display

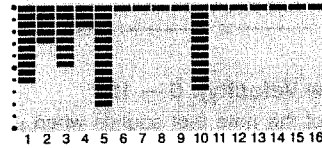

Type 7 : Reverse 2

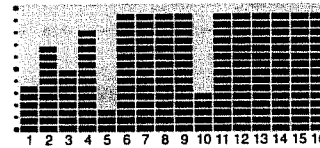

Type 4 : Top to bottom single segment display

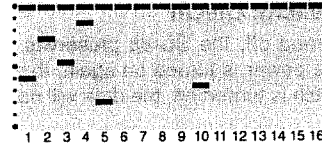

Type 8 : Reverse 2

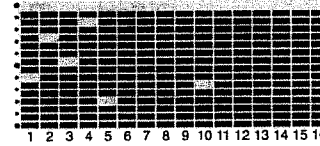

○ **Peak Hold: Off/Type1 — Type3**

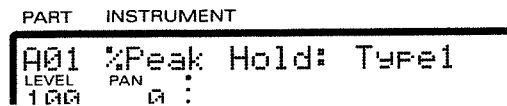

In the SC-88 display, the highest dot in the bar level display will be held on for a short time after the volume falls below it. You can select one of the following four ways in which this Peak Hold function will work.

For Type 1 and Type 3, the dots of the peak level indicator will move downward if the Display parameter explained above is set to Type 3, 4, 7 or 8.

- Off : The peak level will not be held
- Type1 : After holding the peak level, the peak level dot will move downward
- Type2 : After holding the peak level, the peak level dot will disappear
- Type3 : After holding the peak level, the peak level dot will move upward

○ **LCD Contrast: 1 — 16**

Depending on the angle at which the SC-88 is placed, the display can sometimes be difficult to read. If so, adjust the contrast of the display. Higher values will make the characters darker.

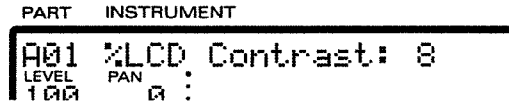

○ **IN B Sel. (IN B Select): Front/Rear**

This setting determines which of the two MIDI IN B connectors will be used. ([☞](#) p.6-10)

* After the setting of this switch is changed, the power must be turned on once again for the new setting to take effect.

○ **OUT/THRU (OUT/THRU Select): OUT/THRU**

This setting determines whether the rear panel MIDI OUT/THRU connector will function as OUT or as THRU. ([☞](#) p.6-11)

* After the setting of this switch is changed, the power must be turned on once again for the new setting to take effect.

○ **In Mode (Input mode): Standard, X-connect, Merge → A, Merge → B, A only**

This setting determines how data received at MIDI IN A and B will be passed on to the Part Groups. ([☞](#) p.6-12)

* After the setting of this switch is changed, the power must be turned on once again for the new setting to take effect.

○ **Rx Sys Mode (System Mode Set Receive Switch): On/Off**

The selection of Single Module Mode or Double Module Mode (p.4-16) is called the System Mode. The Rx Sys Mode setting is the receive switch for MIDI messages (System Mode Set p.7-24) that select the System Mode. If Rx Sys Mode is turned Off, the mode will not change even if System Mode Set messages are received. If Rx Sys Mode is turned On, the mode will change. ([☞](#) p.6-12)

■ Creating a Drum Set (Drum Edit)

A Drum Part has assigned to it a group of various percussion instrument sounds which are called a Drum Set. Unlike a Normal Part, a Drum Part sounds a different instrument for each note number. Since a Drum Part needs to simultaneously produce a wide variety of sounds such as bass drum, snare, tom and cymbal, this is very convenient. A collection of such sounds each assigned to their own note number is called a Drum Set. Each sound within a Drum Set is called an Instrument. (Drum Set list p.7-16)

On the SC-88, you can modify various drum instrument parameters to get the drum sounds most suitable for your musical needs. A "parameter" is something that affects the sound. The process of modifying parameter values is called "editing." The sound parameters you can edit will affect the volume, stereo position, pitch, and effects of the sound.

For each instrument (Drum Instrument) of the currently selected Drum Set, you can modify the values for the following parameters. These parameter values are set independently for each Drum Instrument assigned to a note number.

Volume, Pan (stereo position), Pitch, Reverb send level, Chorus send level, Delay send level, Assign group.

* Drum Sets you create can be stored in internal memory. (* p.4-6, 7)

● Drum editing procedure

1. Make sure that the [ALL] indicator is dark.

If it is lit, press the [ALL] button to turn it off.

2. Use the PART [◀] [▶] buttons to select the Drum Part. Drum Parts are indicated by an "*" mark at the left of the sound name.

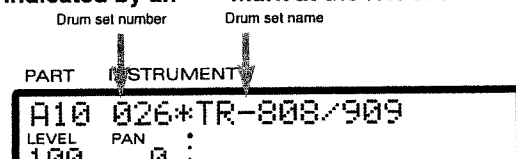

3. Use the INSTRUMENT [◀] [▶] buttons to select a Drum Set.

If you press the [SC-55 MAP] button to make the indicator light, you can select the same Drum Sets as in the SC-55/55mkII. SC-55/55mkII drum sets are indicated by a "" mark at the left of the Drum Set name. Your editing will apply to the Drum Set you select here.

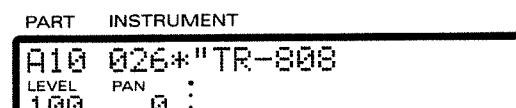

4. Simultaneously press both the USER INST EDIT [SELECT] and DELAY [◀] button.

The display will show the Part Group, the Part Mode, Drum Set number, sound name, and Drum Instrument name.

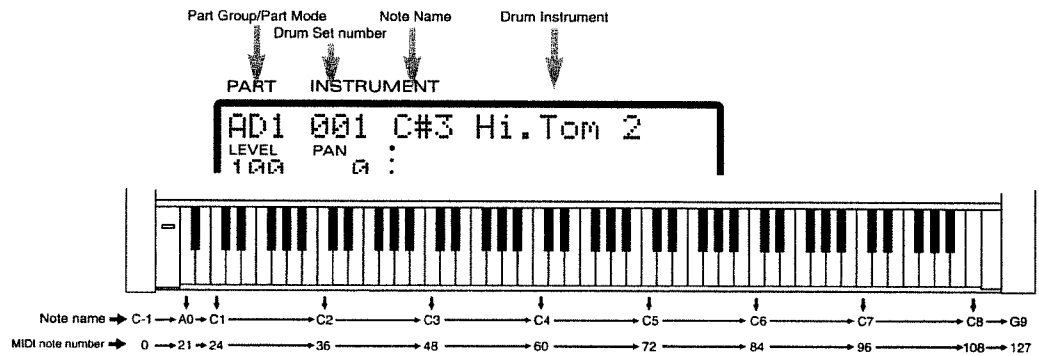

* The Note name is the name of each note (key) on the keyboard, and corresponds to the MIDI Note Number. The Drum instrument is assigned to note number.

5. Use the INSTRUMENT [◀] [▶] buttons select the Drum Instrument you wish to edit.

Here you can also select Drum Sets. Since in both cases you use the INSTRUMENT [◀] [▶] buttons to specify the number. You will need to switch between Drum Set select mode and Drum Instrument select mode, simultaneously press both the INSTRUMENT [◀] [▶] buttons. When you are selecting Drum Sets, the Drum Set number will blink.

* Be aware that if you select a different Drum Set, the parameter Value will be initialized.

6. Use the front panel parameter buttons to modify the parameter values.

The values you set will appear in the appropriate location (field) of the display.

- LEVEL [◀] [▶] : set the volume of each instrument
- PAN [◀] [▶] : set the pan of each instrument
- REVERB [◀] [▶] : set the reverb send level of each instrument
- CHORUS [◀] [▶] : set the chorus send level of each instrument
- DELAY [◀] [▶] : set the delay send level of each instrument
- KEY SHIFT [◀] [▶] : pitch coarse (adjust the pitch of each instrument in semitone steps)
- MIDI CH [◀] [▶] : assign group (*p.2-30)

7. To return to the previous display, simultaneously press both the USER INST EDIT [SELECT] and DELAY [◀] button once again.

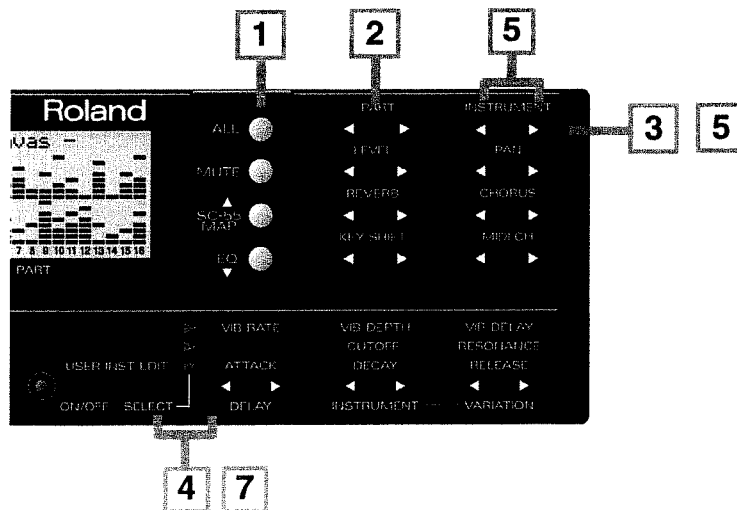

● Using Chorus and Delay

Delay will not be applied to a Drum Instrument for which a number is displayed in the CHORUS column. In this case, you can apply delay by using the DELAY [◀ ▶] buttons to set the delay send level. In other words, in the case of chorus and delay, only the one you specify last will be valid.

In the case of a Drum Instrument, it is not possible to simultaneously use both chorus and delay. Chorus will not be applied to a Drum Instrument for which "d" and "D" is displayed in the CHORUS column (Fig.2). In this case, you can apply chorus by using the CHORUS [◀ ▶] buttons to set the chorus send level (Fig.1).

Drum edit screen

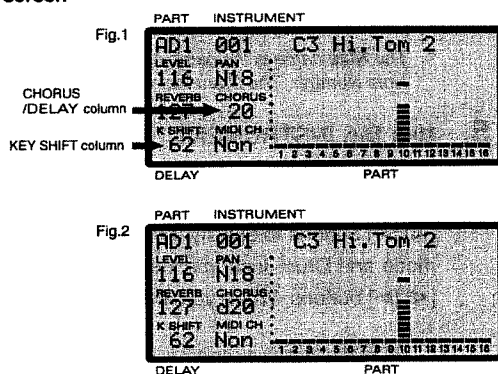

* The Delay setting will be displayed as "d00" — "d99" for values of 0 to 99, and as "D00" — "D27" for values of 100 to 127.

● About the Assign Group

Each instrument can be given a number, and instruments with the identical number are treated as an Assign Group. No two instruments of the same Assign Group will sound together. If while one instrument is sounding, a MIDI message is received to play another instrument in the same Assign Group, the first instrument will be turned off first. This is a useful way to prevent two instruments from sounding simultaneously that would not normally do so. For example since it is obviously impossible for a hi-hat to simultaneously produce both an open hi-hat sound and a closed hi-hat sound, these two sounds could be set to the same Assign Group (the same number) so that they would not sound together.

Numbers from Non, 1 to 127 can be selected, but instruments for which Non is selected will not be turned off by other instruments. In other words, instruments with a setting of Non will not be treated as an Assign Group.

* Be aware that if you select a different Drum Set, the parameter values will be initialized.

Chapter 3

Effects

■ Effect settings

The effects of the SC-88 include 8 types of reverb and chorus, and 10 types of delay. In addition, for each of these effects you can specify parameter values such as character, depth, rate and time. Reverb is an effect that adds reverberation to a sound, as you would hear in a concert hall. Chorus broadens the spatial image of the sound, adding depth and richness. Delay creates echoes. It is also possible to give depth and width to a sound by adding a short delay to the original sound. For these effects, you can set the overall level for all Parts and also individual levels for each Part.

The SC-88 has a two-band equalizer (high range, low range). An equalizer lets you boost or cut specified frequency ranges of a sound to adjust the tone. For each range, high and low, you can specify the frequency and the amount of boost or cut (gain).

● Equalizer setting procedure

- * The equalizer cannot be used when Double Module Mode (☞ p.4-16) is selected.
- * The equalizer can be turned on/off for all Parts together (☞ p.2-21), and also on/off for individual Parts (☞ p.2-10).

1. Press [ALL] to make the button indicator light.
2. Press USER INST EDIT [SELECT] to get the equalizer setting display.

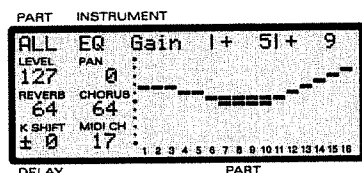

3. Use the Parameter edit DELAY [◀] [▶] buttons to select gain or frequency screen.

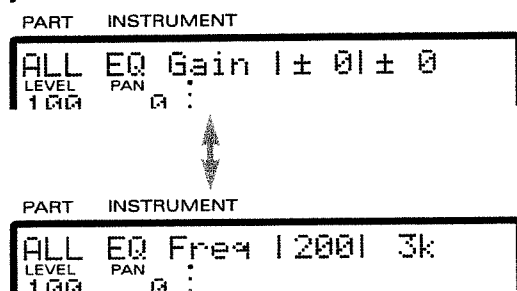

4. Use the INSTRUMENT [◀] [▶] buttons to adjust the Low Gain or the Low Gain. Use the VARIATION [◀] [▶] buttons to adjust the High Gain or the High Frequency.

* The equalizer gain settings you make here are common to all Parts. They cannot be set independently for individual Parts.

5. When you finish making settings, press USER INST EDIT [SELECT] once again to end the procedure. Then the previous display will reappear.

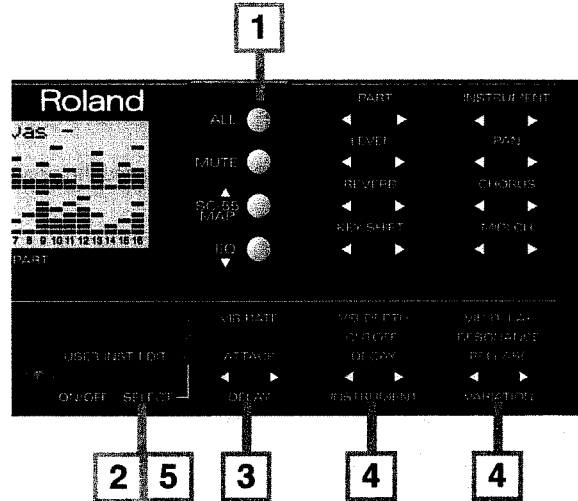

● Equalizer parameter functions

○ Gain (Low Gain / High Gain): -12 — 0 — +12dB

Specify the amount of boost or cut (gain) for the high frequency range (high) and the low frequency range (low). Positive (+) settings will boost, and negative (-) settings will cut.

* With a Gain setting of 0, the equalizer will have no effect.

○ EQ Low Freq (Equalizer Low Frequency): 200, 400 Hz

○ EQ High Freq (Equalizer High Frequency): 3, 6 kHz

These parameters set the cutoff frequencies of the ranges boosted or cut by the equalizer.

● When you want to adjust effect depth for all Parts

1. Press [ALL] to make the button indicator light.
2. Press the button of the effect you wish to adjust.
REVERB [◀] [▶] : reverb level of all Parts
CHORUS [◀] [▶] : chorus level of all Parts
DELAY [◀] [▶] : delay level of all Parts
[EQ] : equalizer on/off for all Parts
3. If you simultaneously press both [◀] [▶] buttons of REVERB, CHORUS or DELAY, the current parameter values for all Parts will be displayed graphically.
Simultaneously press both buttons once again and the previous display will reappear.

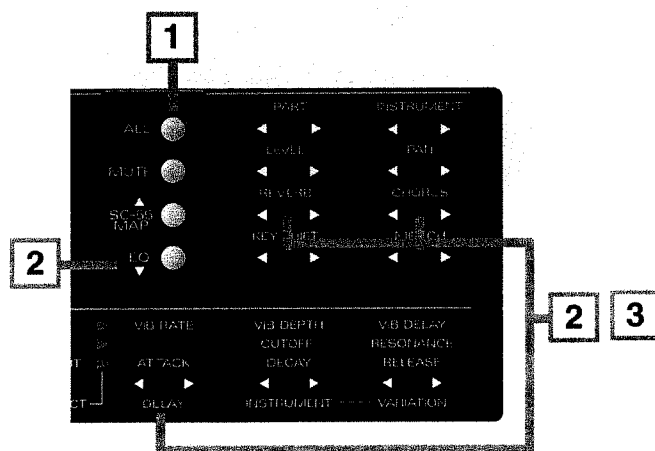

● When you want to adjust effect depth for each Part

1. Make sure that the [ALL] indicator is dark.
If it is lit, press the [ALL] button to turn it off.
2. Use the PART [◀] [▶] buttons to select the Part you wish to modify.
3. Press the button of the effect you wish to adjust.
REVERB [◀] [▶] : reverb level of each Part
CHORUS [◀] [▶] : chorus level of all Parts
DELAY [◀] [▶] : delay level of all Parts
[EQ] : equalizer on/off for each Part
4. If you simultaneously press both the [◀] and [▶] buttons of REVERB, CHORUS or DELAY, the current parameter value for all Parts will be displayed graphically.
Simultaneously press both buttons once again and the previous display will reappear.

● Setting Reverb/Chorus/Delay parameters

Here's how to make settings for reverb, chorus, delay and equalizer. These parameters are common to all Parts, and cannot be set independently for individual Parts.

1. Press [ALL] to make the button indicator light.
2. Simultaneously press both the PART [◀] [▶] buttons.
3. Use [▲] [▼] to select the parameter you wish to modify.

```
PART  INSTRUMENT
ALL  >Reverb:  Hall2
LEVEL PAN  :
100  G  :
```

4. Use INSTRUMENT [◀] [▶] to set the value.

```
PART  INSTRUMENT
ALL  >Reverb:  Plate
LEVEL PAN  :
100  G  :
```

5. When you finish making settings, simultaneously press both PART [◀] [▶] buttons to end the procedure.

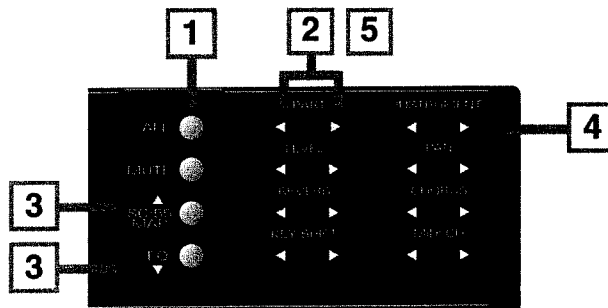

* Delay cannot be used when Double Module Mode (see p.4-16) is selected.

● Reverb/Chorus/Delay parameter functions

○ Reverb Type

Reverb is an effect that adds reverberation to a sound, as you would hear in a concert hall. You can choose from 8 types of reverb.

Room1 Room2 Room3

These reverbs simulate the reverberation of a room. They provide a well-defined spacious reverberation.

Hall1 Hall2

These reverbs simulate the reverberation of a concert hall. They provide a deeper reverberation than the Room reverbs.

Plate

This simulates a plate reverb (a studio device using a metal plate).

Delay

This is a conventional delay that produces echo effects.

Panning Delay

This is a special delay in which the delayed sounds move left and right. It is effective when you are listening in stereo.

○ Chorus Type

Chorus broadens the spatial image of the sound, adding depth and richness. You can choose from 8 types of chorus.

Chorus1 Chorus2 Chorus3 Chorus4

These are conventional chorus effects that add spaciousness and depth to the sound.

Feedback Chorus

This is a chorus with a flanger-like effect and a soft sound.

Flanger

This is an effect sounding somewhat like a jet airplane taking off and landing.

Short Delay

This is a delay with a short delay time.

Short Delay (FB)

This is a short delay with many repeats.

○ Delay Type

Delay creates echoes. It is also possible to give depth and width to a sound by adding a short delay to the original sound. You can choose from 10 types of delay.

Delay1 Delay2 Delay3

These are conventional delays. 1, 2 and 3 have progressively longer delay times.

Delay4

This is a delay with a rather short delay time.

Pan Delay1 Pan Delay2 Pan Delay3

The delay sound moves between left and right. This is effective when listening in stereo. 1, 2 and 3 have progressively longer delay times.

Pan Delay4

This is a rather short delay with the delayed sound moving between left and right. It is effective when listening in stereo.

Dly ToRev

Reverb is added to the delay sound which moves between left and right. It is effective when listening in stereo.

PanRepeat

The delay sound moves between left and right, but the pan positioning is different than the effects listed above. It is effective when listening in stereo.

* Delay cannot be used when Double Module Mode (* p.4-16) is selected.

When you change the Reverb/Chorus/Delay Type, the following parameter values will automatically change. This is so that the parameter values will have the settings most appropriate for the selected Effect Type. You can select these parameters (*see* p.3-5) and modify the values to adjust the effect to your taste.

● Reverb parameters

○ Rev Charac. (Reverb Character) 0 — 7

This parameter selects the type of reverb. 0 — 5 are reverb effects, and 6 and 7 are delay effects.

○ Rev Pre-LPF (Reverb Pre Low Pass Filter) 0 — 7

A low pass filter can be applied to the sound coming into the reverb to cut the high frequency range. Higher values will cut more of the high frequencies, resulting in a more mellow reverberation.

○ Rev Level (Reverb Level) 0 — 127

This parameter sets the amount of the reverberant sound. Higher values result in louder reverberation.

○ Rev Time (Reverb Time) 0 — 127

This parameter sets the time over which the reverberation will continue. Higher values result in longer reverberation.

○ Rev Delay Fb (Reverb Delay Feedback) 0 — 127

This parameter is used when the Reverb Type is set to Rev Charac. 6, 7 Delay or Panning Delay. It sets the way in which delays repeat. Higher values result in more delay repeats.

○ RevPreDlyT (Reverb Pre-Delay Time) 0ms — 127ms

This parameter sets the delay time until the reverberant sound is heard. Higher values result in a longer pre-delay time, simulating a larger reverberant space.

* *Delay cannot be used when Double Module Mode (*see* p.4-16) is selected.*

● Chorus parameters

○ Cho Pre-LPF (Chorus Pre Low Pass Filter) 0 — 7

A low pass filter can be applied to the sound coming into the chorus to cut the high frequency range. Higher values will cut more of the high frequencies, resulting in a more mellow chorus sound.

○ Cho Level (Chorus Level) 0 — 127

This parameter sets the amount of the chorus sound.

○ ChoFeedback (Chorus Feedback Level) 0 — 127

This parameter sets the level at which the chorus sound is re-input (fed back) into the chorus. By using feedback, a denser chorus sound can be created. Higher values result in a greater feedback level.

○ Cho Delay (Chorus Delay Time) 0 — 127

This parameter sets the delay time of the chorus effect. Higher values will cause greater deviation in pitch of the chorus sound.

○ Cho Rate (Chorus Rate) 0 — 127

This parameter sets the speed (frequency) at which the chorus sound is modulated. Higher values result in faster modulation.

○ Cho Depth (Chorus Depth) 0 — 127

This parameter sets the depth at which the chorus sound is modulated. Higher values result in deeper modulation.

○ Cho → Reverb (Chorus Send Level To Reverb) 0 — 127

This parameter sets the amount of chorus sound that will be sent to the reverb. Higher values result in more sound being sent.

○ Cho → Dly (Chorus Send Level To Delay) 0 — 127

This parameter sets the amount of chorus sound that will be sent to the delay. Higher values result in more sound being sent.

* *Chorus Send Level To Delay cannot be used when Double Module Mode (p.4-16) is selected.*

● Delay parameters

○ **Dly Pre-LPF (Delay Pre Lowpass Filter) 0 — 7**

A low pass filter can be applied to the sound coming into the delay to cut the high frequency range. Higher values will cut more of the high frequencies, resulting in a more mellow delay sound.

○ **Dly Time C (Delay Time Center) 0.1ms — 1.0s**

The delay effect of the SC-88 allow you to set three delay times; center, left and right (when listening in stereo). Delay Time Center sets the delay time of the delay located at the center.

○ **DlyTRatioL (Delay Time Ratio Left) 4% — 500%**

This parameter sets the delay time of the delay located at the left as a percentage of the Delay Time Center. (up to a max. of 1.0s)

○ **DlyTRatioR (Delay Time Ratio Right) 4% — 500%**

This parameter sets the delay time of the delay located at the right as a percentage of the Delay Time Center. (up to a max. of 1.0s)

○ **Dly Level C (Delay Level Center) 0 — 127**

This parameter sets the volume of the central delay. Higher values result in a louder center delay.

○ **Dly Level L (Delay Level Left) 0 — 127**

This parameter sets the volume of the left delay. Higher values result in a louder left delay.

○ **Dly Level R (Delay Level Right) 0 — 127**

This parameter sets the volume of the right delay. Higher values result in a louder right delay.

○ **Dly Level (Delay Level) 0 — 127**

This parameter sets the overall volume of the three delays (center, left and right). Higher values result in a louder overall delay.

○ **Dly Fback (Delay Feedback) -64 — 0 — +63**

This parameter affects the number of times the delay will repeat. With a value of 0, the delay will not repeat. With higher values there will be more repeats. With negative (-) values, the center delay will be fed back with inverted phase. Negative values are effective with short delay times.

○ **Dly → Rev (Delay Send Level To Reverb) 0 — 127**

This parameter sets the amount of delay sound that is sent to the reverb. Higher values result in more sound being set.

* *Delay cannot be used when Double Module Mode (≡ p.4-16) is selected.*

● About the SC-88's effect structure

The SC-88 effects that are available are somewhat different depending on whether you have selected Single Module Mode or Double Module Mode. In Double Module Mode, you cannot use the equalizer or delay, but you can simultaneously use two sets each of reverb and chorus. This is useful when you wish to apply different effects or settings to different Parts.

* For details of Single and Double modes, refer to p.4-16.

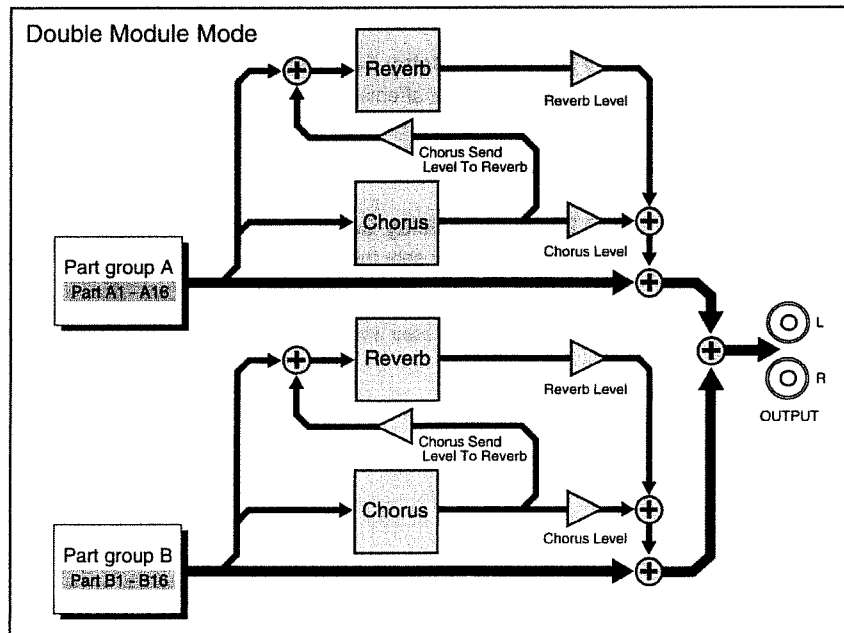
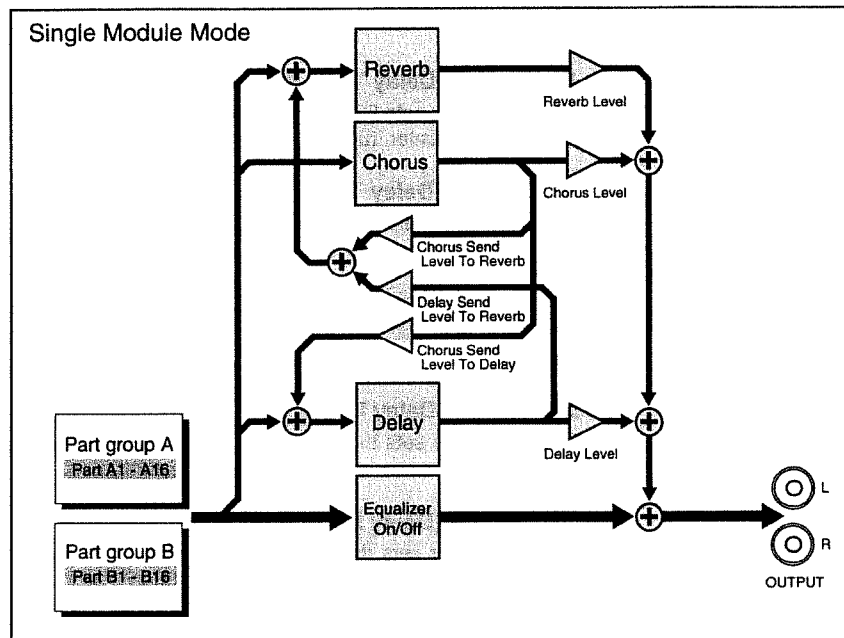

Chapter 4

Convenient functions

■ Create and save a sound (User Instrument Edit)

You can modify the parameters of an SC-88 sound to your taste, and save your new settings in Variation numbers 64 or 65 of the SC-88 map (*see* p.4-4). A sound saved in this way is called a User Instrument, and this procedure is called User Editing. You can save 256 different sounds in this way.

The following parameters can be set

Vibrato
Filter
Envelope

For the function of each parameter, refer to p.2-18.

The values of these user parameters will not change even if MIDI messages other than user settings are received, but since Part parameters are affected by MIDI messages, the final result you hear will be affected by MIDI messages.

* *Messages that modify the sound, such as System Exclusive messages and NRPN messages (*see* p.6-6, 8).*

The other sound parameters will use the values specified for the Part (Part parameters, p.2-17). Each Part has Part parameters which are named identically to the User parameters listed above which can be set for each sound. This means that the parameter value that actually applies to the sound will be a combination of these two settings. For example, if the Vibrato Rate has been set to +20 as a Part parameter, and to -5 as a User sound parameter, the Vibrato Rate of the resulting sound will be $20-5=+15$.

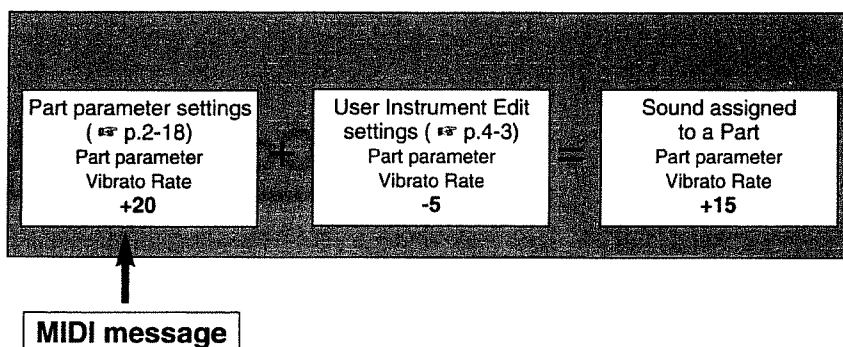

● Procedure for creating and storing a sound

- 1. Make sure that the [ALL] indicator is dark.**
If it is lit, press the [ALL] button to turn it off.
- 2. Use PART [◀] [▶] to select a normal Part, then use the INSTRUMENT [◀] [▶] buttons to select the sound you wish to start from.**
Your edits will apply to this sound. If you wish to select a Variation sound, press [VARIATION] and select a sound.

```

PART  INSTRUMENT
A16  032  Gt.Harmonics
LEVEL PAN  :
100   0  :
  
```

- 3. Press the USER INST EDIT [ON/OFF] button to make the indicator light.**
Be aware that if this indicator is not lit, you will be editing not User sound parameters but Part parameters (see p.2-17).

* If a User sound is already selected, the indicator will not light even if you press the USER INST EDIT [ON/OFF] button.

- 4. Press the [SELECT] button and select the sound parameter you wish to modify. Use the appropriate parameter edit buttons [◀] [▶] to modify the value.**

For an explanation of sound parameters and the procedure for modifying them, refer to p.2-17.

(Example) Vibrato editing display

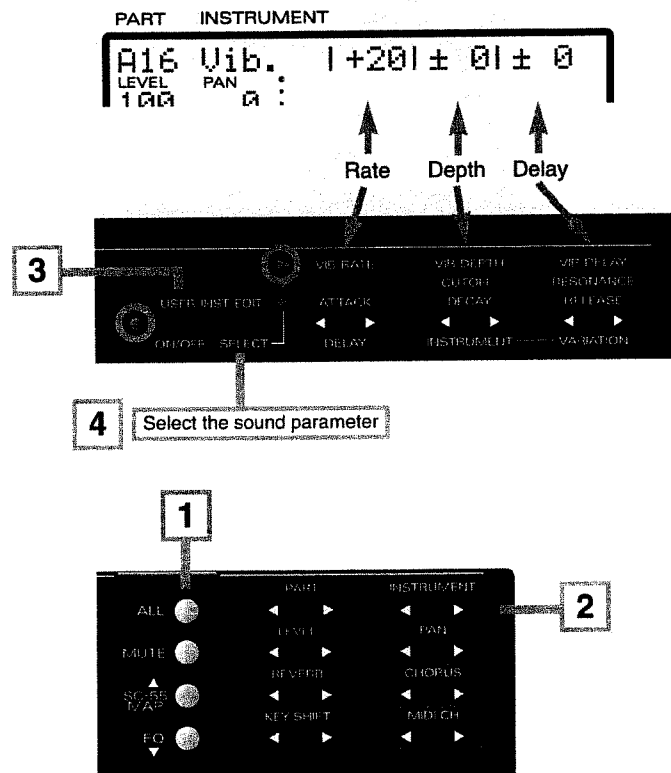

5. Simultaneously press USER INST EDIT [ON/OFF] and [SELECT].

The display will ask "Write UI 64/001?". Use INSTRUMENT [◀] [▶] to select instrument number (1-128) and the variation number (64 or 65 : SC-88Map) in which an original sound stored. Simultaneously pressing both INSTRUMENT [◀] and [▶] will move between the two numbers.

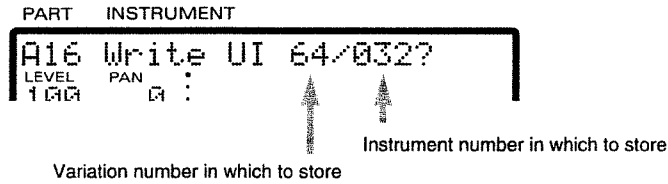

6. When you press [ALL] the sound will be stored.

If you decide not to store, press [MUTE].

7. Press the USER INST EDIT [ON/OFF] button to turn off the indicator and complete the procedure.

* User sound parameter values can be transmitted as MIDI Exclusive messages (see p.4-10). Data that is transmitted in this way can be saved using a sequencer or computer, and re-transmitted back to the SC-88 to save and restore User sound data.

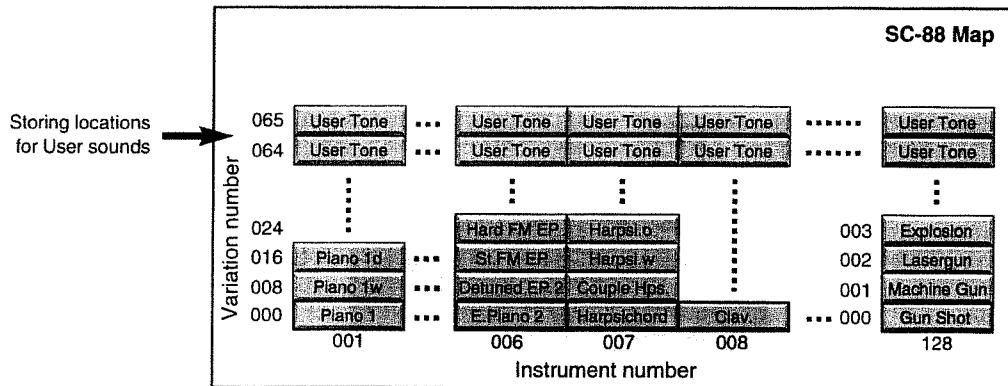
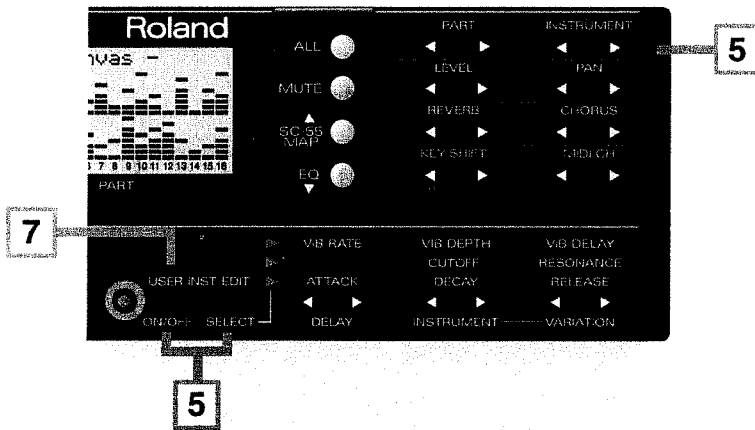

■ Saving a Drum Set you created (User Drum Edit)

You can modify drum sound parameters to your liking, and save this data as a Drum Set. A Drum Set saved in this way is called a User Drum Set. You can save up to two Drum Sets, and since each set contains 84 (*) instrumental sounds, this provides a total of 168 instrumental sounds (Drum Instruments). User Drum Sets are stored in Drum Set numbers 65 and 66 of the SC-88 map (see p.4-6). You can also give each User Drum Set a name of your choice (see p.4-8).

(*) Instrumental sounds in a Drum Set are assigned to each key (note) of note numbers 25 to 108.
(Drum Set list, see p.7-16)

● Creating and storing a Drum sound

1. Use the procedure given in "Drum editing procedure" (p.2-28) to select a Drum Part and Drum Set, and create a drum sound.

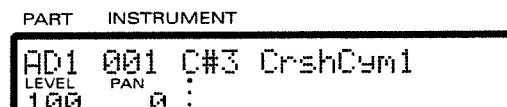

If the above screen is displayed after you create a drum sound, you can use the following procedure to save your data as a User Drum Set. If the screen display is different than the one shown above, use following procedure 2, 3.

2. Make sure that the [ALL] indicator is dark.
If it is lit, press [ALL] to turn it off.
3. Simultaneously press USER INST EDIT [SELECT] and DELAY [←].
The display will show the Part Group (see p.2-8), Part Mode (see p.2-13), Drum Set number, Note name, and Drum Instrument name (see p.2-29).

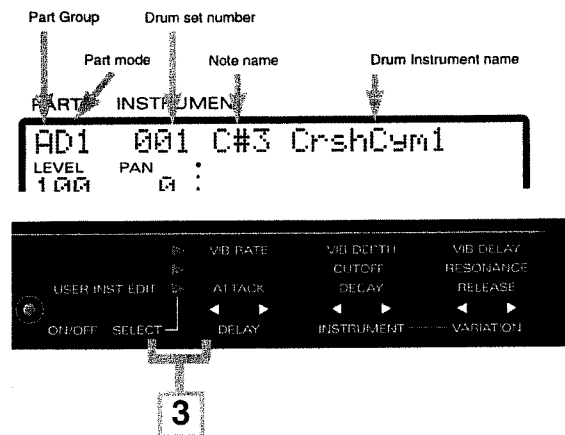

There are two ways to store an edited drum sound. The first is to store each Drum Instrument individually (procedure 1). The second is to store an entire set of Drum Instruments as a Drum Set (procedure 2).

○ **Storing an individual Drum Instrument (procedure 1)**

The following procedure will store an individual Drum Instrument into the Note Name you specify.

4-1. To store an individual Drum Instrument, simultaneously press the USER INST EDIT [SELECT] and [ON/OFF] buttons.

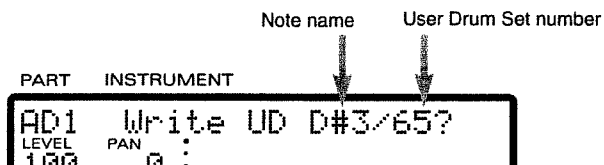

Use the INSTRUMENT [◀] [▶] buttons to specify the Note Name and the User Drum Set number (65/66) into which the data will be stored. When you simultaneously press the INSTRUMENT [◀] [▶] buttons, the cursor will move between the Note Name and the Drum Set number.

5. To store the data, press [ALL].
To quit without storing, press [MUTE].

Procedure 1

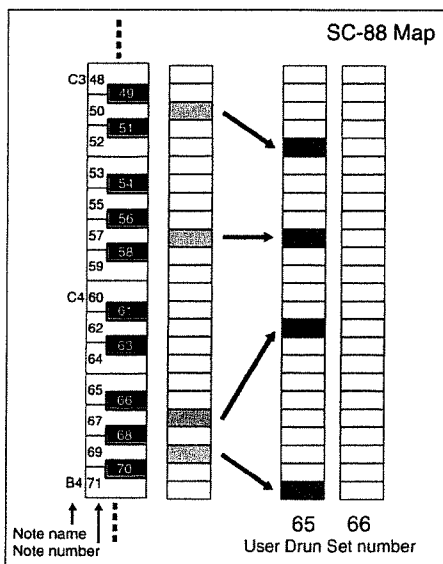

Procedure 2

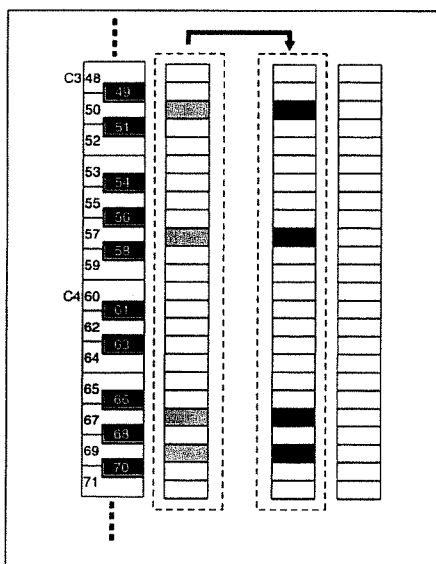

○ Storing an entire Drum Set (procedure 2)

The following procedure will store all the Drum Instruments for the entire currently selected Drum Set.

4-2. To store the entire Drum Set, simultaneously press **VARIATION** [◀] [▶] buttons.

Use the **INSTRUMENT** [◀] [▶] buttons to specify the User Drum Set number (65/66) into which the data will be stored.

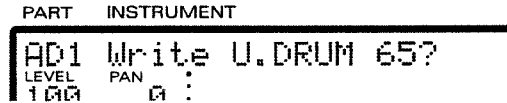

5. To store the data, press [ALL].

To quit without storing, press [MUTE].

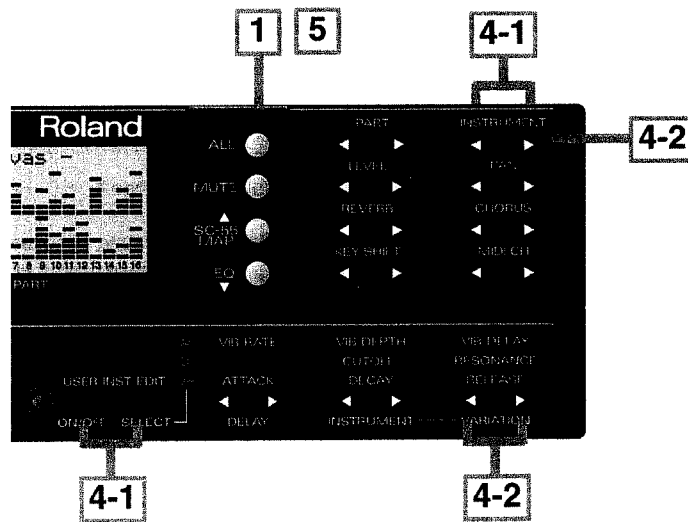

● Naming a User Drum Set

1. Make sure that the [ALL] indicator is dark.
If it is lit, press [ALL] to turn it off.

2. Simultaneously press PAN [▶] and CHORUS [▶].

The character at the cursor location will blink.

```

PART  INSTRUMENT
SET  065*USER DRUM 1
LEVEL PAN  :
100  0  :
```

3. Use PART [◀] [▶] to select a Drum Part, then use PART [◀] [▶] to move the cursor where you wish to input a character.

The blinking area will move.

4. Use INSTRUMENT [◀] [▶] to select the desired character.

Then repeat from step 3.

Each time you press [ALL], the character will change Æ → æ → Ø → Å.

Pressing [MUTE] will enter a space.

Pressing [SC-55 MAP] will select 0.

Each time you press [EQ], the symbol will change & → € → & → ¢.

If you wish to change the User Drum Set number, simultaneously press both INSTRUMENT [◀] and [▶] buttons, and then use INSTRUMENT [◀] [▶] to select the number.

```

PART  INSTRUMENT
SET  066*My Drum Set
LEVEL PAN  :
100  0  :
```

* To store the name of the User Drum Set in memory, follow the steps explained in "Storing an entire Drum Set (procedure 2)" on p. 4-7.

5. Simultaneously press PAN [▶] and CHORUS [▶] to end the procedure.

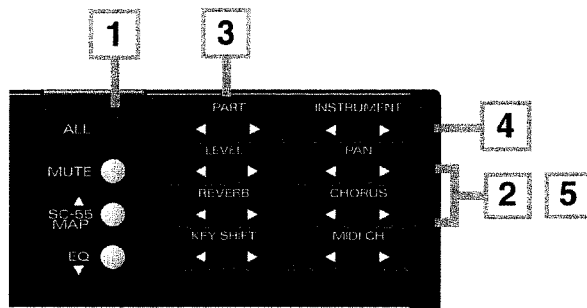

■ Create a display message

When you press [ALL] to make the indicator light, the screen will display a message of "--SOUND Canvas--". You can change this message. The message you create can be saved on a sequencer or computer as MIDI Exclusive data (p.4-10), so you can use it as the title of a SC-88 setup. When this System Exclusive data is once again transmitted to the SC-88, that message will appear in the display.

● Inputting the display message

1. Press [ALL] to make the indicator light.
2. Simultaneously press the PAN [▶] and CHORUS [▶] buttons.

The character location being specified will blink.

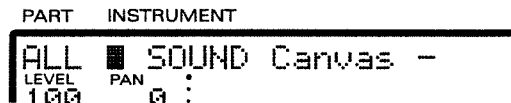

3. Use PART [◀] [▶] to move to the character you wish to specify.
The blinking area will move.
4. Use the INSTRUMENT [◀] [▶] buttons to select the character you wish.

Then repeat from step 3.

Each time you press [ALL], the character will change A → a → Ø → Å.

Pressing [MUTE] will enter a space.

Pressing [SC-55 MAP] will select 0.

Each time you press [EQ], the symbol will change & → < → & → <.

5. Simultaneously press PAN [▶] and CHORUS [▶] to complete the procedure.

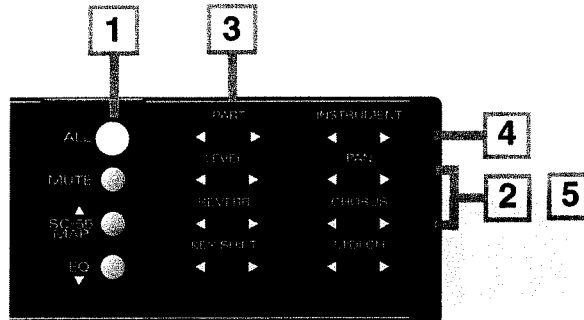

■ Recording all settings on a sequencer

The SC-88 is able to transmit all its settings as MIDI data. The transmitted data can be saved using a sequencer or personal computer. You can also transmit the saved data to another SC-88 in order to give it the identical parameter settings.

Data is transmitted as system exclusive data. This process is called a Bulk Dump.

● Bulk Dump procedure

1. Set the MIDI OUT/THRU (p.6-11) select switch to OUT.
2. Use a MIDI cable to connect the SC-88 MIDI OUT/THRU connector to the sequencer's MIDI IN connector.
3. Press [ALL] to make the button indicator light.
4. Simultaneously press both the INSTRUMENT [◀] [▶] buttons.
The display will ask "DUMP ALL, Sure?", and the data is now ready to be transmitted.
5. Use INSTRUMENT [◀] [▶] to select the type of data you wish to transmit.
 - ALL : all parameters of the SC-88
 - ALL-U : all parameters except User Instrument and Drum settings
 - U. INST : User Instrument settings
 - U. DRUM : User Drum settings
 - GS A : GS parameters for Part A
 - GS B : GS parameters for Part A
6. Start the sequencer recording.
7. Press [ALL] and data transmission will begin.
The "Transmitting" display will appear while the SC-88 transmits data. (To cancel data transmission, press [MUTE].)
8. When data transmission is complete, stop recording on the sequencer.

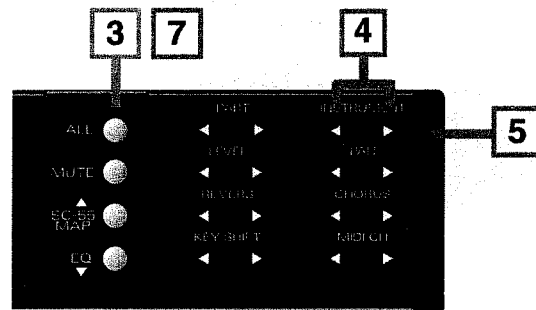

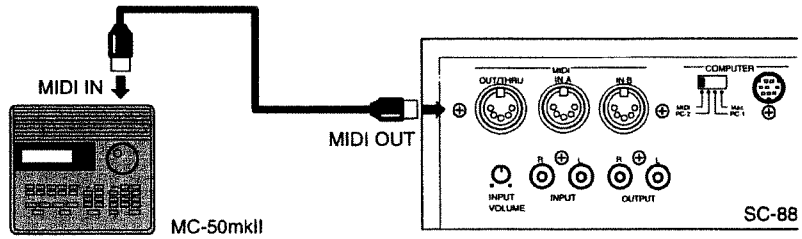

* Since this operation transmits a large amount of data, make sure that the receiving MIDI device has sufficient memory. If the receiving device has insufficient memory, recording will not be completed. If you transmit data for all Parts, the bulk data transmitted by the SC-88 is about 26 Kbytes.

The data will not be transmitted when MIDI OUT/THRU Select ( p.6-11) is set to THRU.

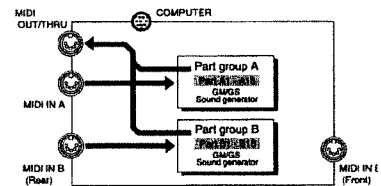

It is also possible to transfer data to a computer via the computer connector without using the MIDI connectors. ( p.5-2)

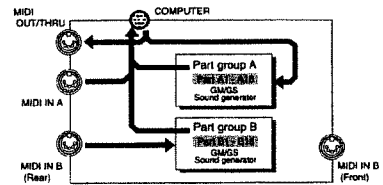

■ Draw pictures or characters in the display (Frame Draw)

You can use the square dots of the SC-88 display to draw pictures or characters. This is called the Frame Draw function. Ten picture screens can be stored. Each of the ten screens is called a "Page." You can transmit the picture data as a MIDI System Exclusive message and save it to a sequencer or computer, and then re-transmit it to the SC-88 to make pictures or characters be displayed in time with the music.

● Creating the picture or character data

1. Simultaneously press the DELAY [▶] and INSTRUMENT [◀] buttons.

The display will show "FrameDraw:Page 1".

2. Use INSTRUMENT [◀] [▶] to select the page you wish to use.

3. Move the cursor, and use the button operations listed below to turn each dot on or off to create a picture or characters. The dot will blink at the cursor location.

[▲] [▼]	: move the cursor up/down
PART [◀] [▶]	: move the cursor left/right
[ALL]	: turn the dot on (lit)
[MUTE]	: turn the dot off (dark)
CHORUS [◀] [▶]	: shrink dots/expand dots
LEVEL [◀] [▶]	: move the displayed picture down/picture up
PAN [◀] [▶]	: move the displayed picture left/right
INSTRUMENT [◀]*[▶]	: to transmit the screen data to an external device

* Indicates that both buttons must be pressed simultaneously.

* Be aware that the screen data will not be transmitted from MIDI OUT connector if MIDI OUT/THRU Select (* p.6-11) is set to THRU.

4. To invert / delete / copy the screen data, use the following procedures.

- (A) To invert the screen, press REVERB [◀] or [▶].
A message will ask "Invert Page *?". Use INSTRUMENT [◀] [▶] to specify the page to be inverted.
- (B) To erase the screen, press MIDI CH [◀] or [▶].
A message will ask "Clear Page *?". Use INSTRUMENT [◀] [▶] to specify the page to be cleared.
- (C) To copy the screen, press KEY SHIFT [◀] or [▶].
A message will ask "Copy to Page *?". Use INSTRUMENT [◀] [▶] to specify the copy destination page.

* In the messages given above, "*" indicates the screen page number.

5. For each operation, press [ALL] to execute.

To cancel without executing, press [MUTE].

6. When you finish, simultaneously press DELAY [▶] and INSTRUMENT [◀] to end the procedure.

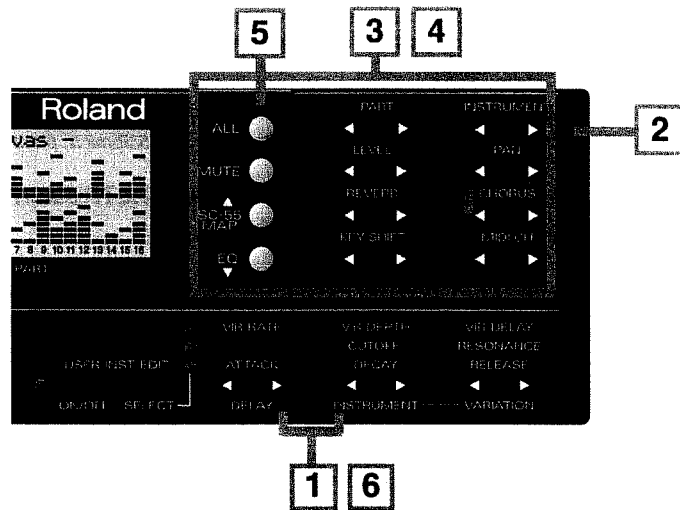

If you wish to display animated pictures, use the LEVEL and PAN buttons in step 3 to move the picture and copy it to the next page to create each frame of the animation. Then in step **3**, (INSTRUMENT [◀]*[▶]) transmit the data for each frame and save it in a sequencer (see p.4-10). Then, before you start playback of the song, transmit this display data to the SC-88, and use the display select command (exclusive data p.7-26) to playback the animation. This allows you to make moving pictures or characters appear in synchronization with the music.

* When screen data is received as a MIDI Exclusive message, the screen data in the SC-88 will be overwritten and lost.

For this procedure, you will need a sequencer (such as the Roland MC-50mkII) that is able to edit, receive and transmit System Exclusive data. Some sequencing software for personal computers is also able to do this. Check the manual for your software.

■ Selecting the CM-64 sound map

The SC-88 can be set to the sound map of the Roland CM-64 (Multi-timbre Sound Module). When you wish to play song data that was created for the CM-64, use the following procedure.

- * Be aware that if you select the CM-64 sound map, all previous settings will be lost.
- * If you wish to use the same sounds as the SC-55/55mk II, press [SC-55 MAP] button.

1. While holding down [SELECT], press INSTRUMENT [◀].

The display will ask "Init CM-64, Sure?".

2. Press [ALL] and the CM-64 sound map will be selected.

To safely cancel the operation press [MUTE].

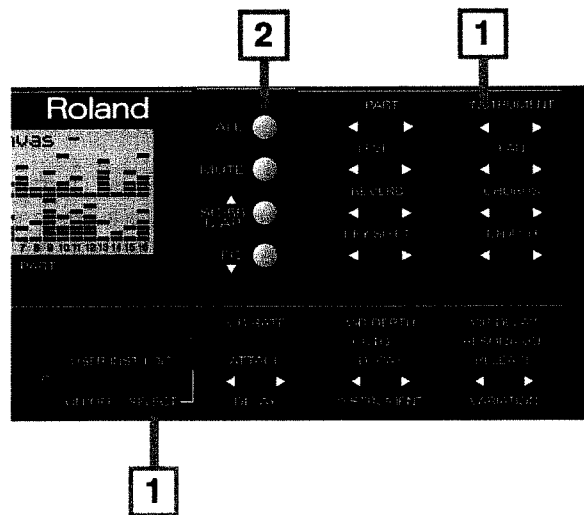

When the CM-64 sound map is selected, the settings of each Part (group A, B) will be as follows.

Part settings

Part name	Rx.Channel	Tone (VARIATION/INSTRUMENT NO)	LEVEL	PAN	REVERB	CHORUS	KEY SHIFT
1	1	Acou Piano 1 (127/001)	100	0	64	0	0
2	2	Slap Bass 1 (127/069)	100	L10	64	0	0
3	3	Str Sect 1 (127/049)	100	L10	64	0	0
4	4	Brs Sect 1 (127/096)	100	L10	64	0	0
5	5	Sax 1 (127/079)	100	L10	64	0	0
6	6	Ice Rain (127/042)	100	L46	64	0	0
7	7	Elec Piano 1 (127/004)	100	R27	64	0	0
8	8	Bottleblow (127/111)	100	L63	64	0	0
9	9	Orche Hit (127/123)	100	R63	64	0	0
10	10	CM-64/32L Set (128)	100	0	64	0	0
11	11	FRETLESS 1 (126/028)	100	0	64	0	0
12	12	CHOIR 1 (126/030)	100	R17	64	0	0
13	13	A.PIANO 1 (126/001)	100	0	64	0	0
14	14	E.ORGAN 2 (126/038)	100	R35	64	0	0
15	15	E.GUITAR 1 (126/014)	100	L37	64	0	0
16	16	SOFT TP 1 (126/047)	100	L19	64	0	0

* Bend Range: +12, Mod Depth: +4

* The names of these sounds are identical to the names on the CM-64, so they differ from what they are called on the SC-88.

Settings for all Parts

LEVEL	PAN	REVERB	CHORUS	KEY SHIFT
127	0	64	64	± 0

● Differences between the CM-64 and the SC-88

When the CM-64 sound map is selected, the playback result will be the same as if a CM-64 were used. However since the internal structure of the sound source is different, the result is not absolutely identical. Please be aware of the following main differences.

1. How the sounds change

When velocity, modulation and aftertouch etc. are used to add expression, the sounds will change in a way slightly different than the CM-64.

2. Exclusive data

The SC-88 is not compatible with CM-64 Exclusive data. If CM-64 Exclusive data is received, SC-88 settings will not change. This means that if the song data contains CM-64 sound data (Exclusive data), playing back that song data will not have the same result as it would have on the CM-64.

3. Pan

The SC-88 pan settings are opposite to those of the CM-64. Please reverse the left/right (L/R) connections of the audio output jacks.

■ Using the SC-88 as two sound modules

The SC-88 has two modes of operation: Single Module Mode (Mode 1) and Double Module Mode (Mode 2). When Double Module Mode is selected, two types of effect can be used simultaneously. For example, you could use different types of reverb on Drum Parts than on Normal Parts. Other parameters can also be set separately in two groups. Normally the SC-88 is in Single Module Mode.

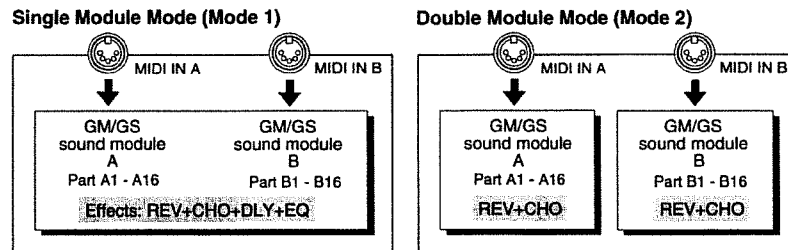

● Selecting Double Module Mode

1. While holding down the USER INST EDIT [SELECT] button, press KEY SHIFT [▶].

The display will ask "Set. Mode2, Sure?"

2. Press [ALL] button, and the SC-88 will be in Double Module Mode.

To cancel the operation, press [MUTE].

At the left of the parameter names, there will be an indication of either A or B. This indicates whether you are setting parameters for Part Group A or B. The parameters indicated as either A or B can be set independently for Part Groups A or B. Use the PART [◀] [▶] buttons to move between groups A and B.

```

PART  INSTRUMENT
A >M. Tune: 440.0
LEVEL PAN a :
1000

```

3. To return to Single Module Mode, while holding down the USER INST EDIT [SELECT] button, press KEY SHIFT [◀]. And press [ALL] button.

To cancel the operation, press [MUTE].

- * The selection of Single or Double Module Mode is remembered when the power is turned off. The mode will not change even if the power is turned off and then on again.
- * Be aware that if you change the operating mode, the settings of each Part will be initialized (GS Reset).

In both Single Module Mode and Double Module Mode, MIDI messages received at MIDI IN A are sent to Group A Parts, and MIDI messages received at MIDI IN B are sent to Group B Parts ([p.2-8](#)). Be aware that the route by which data is passed between the two MIDI IN connectors and each Part is determined by the System parameter Input Mode ([p.6-12](#)) It is possible to specify the address for Exclusive messages so that an Exclusive message received at MIDI A will be passed to Group B Parts. ([p.5-10](#))

In Double Module Mode, two groups are provided for the following parameters.

Master Level	(p.2-22)
Master Pan	(p.2-22)
Master KEY SHIFT	(p.2-22)
Master Tune	(p.1-8)
Reverb Type	(p.3-6)
Reverb Character	(p.3-7)
Reverb Pre-LPF (Reverb Pre Lowpass Filter)	(p.3-7)
Reverb Level	(p.3-7)
Reverb Time	(p.3-7)
Reverb Delay Feedback	(p.3-7)
Chorus Type	(p.3-6)
Chorus Pre-LPF (Chorus Pre-Lowpass Filter)	(p.3-8)
Chorus Level	(p.3-8)
Chorus Feedback (Chorus Feedback Level)	(p.3-8)
Chorus Delay (Chorus Delay Time)	(p.3-8)
Chorus Rate	(p.3-8)
Chorus Depth	(p.3-8)
Chorus Send Level To Reverb	(p.3-8)
Mute Lock	(p.6-14)
Rx GM On (General MIDI System On Receive Switch)	(p.6-14)
Rx GS Reset (GS Reset Receive Switch)	(p.6-14)
Device ID number	(p.6-9)

■ Initialize

● Initialize all Parts to the factory settings

This procedure will initialize all the settings of the SC-88 to the factory settings. This will also initialize System parameters ([p.2-24](#)) and User tones ([p.4-2](#)).

1. While holding down [SELECT], simultaneously press both the INSTRUMENT [◀] [▶] buttons.

The display will ask "Init All, Sure?".

2. To initialize, press [ALL].

To quit without initializing, press [MUTE].

* After the initialization has been performed, the indications in the display for the parameters listed below will show the factory default settings. In fact, however, the settings will not yet at that point be at the defaults. They will be placed at the defaults after you turn power on, then off again.

In Mode, OUT/THRU Select, IN B Select ([p. 6-10](#))

● Initialize for GM/GS

When you wish to playback song data carrying the GM/GS logo, you need to initialize the SC-88 for GM/GS settings. When this is done, the SC-88 will be set to the basic GM/GS settings appropriate for playing back song data carrying the GM/GS logo.

The beginning of song data carrying the GM/GM logo contains data which requests the sound source to initialize itself (General MIDI System On, GS Reset [p.6-15](#)). This means that if you are playing back the song data from the beginning, initialization will be done automatically, and there is no need for you to do it using the front panel buttons.

* Even if the SC-88 is initialized for GS/GM, the System function settings ([p.2-24](#)) will not be affected.
* Even if the Backup Switch ([p.2-25](#)) is on, the following procedure will rewrite it to the factory setting.

1. (For GM) While holding down [SELECT], press PART [▶].
(For GS) While holding down [SELECT], press INSTRUMENT [▶].

The display will ask "Init GM, Sure?" or "Init GS, Sure?"

If you perform this operation in Double Module mode, the display will ask "Init GS A, Sure?". Use INSTRUMENT [◀] [▶] to specify which module A or B will be initialized.

2. To initialize, press [ALL]. To quit without initializing, press [MUTE].

* To playback the song with the same sounds as the SC-55/55mk II, press [SC-55 MAP] button.

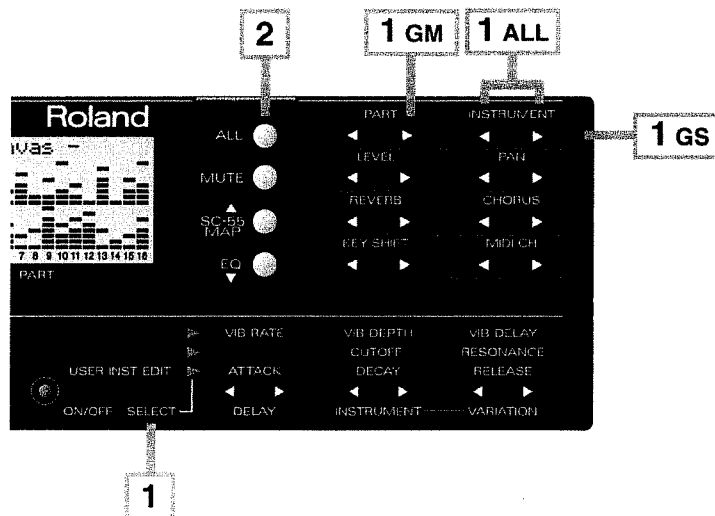

Chapter 5

Using the SC-88 from a personal computer

■ Using the SC-88 from a personal computer

The SC-88 can be controlled by music software running on a personal computer. This will allow you to create your own songs, and also to select sounds or edit sounds from the computer display. This type of system is known as a Desk Top Music System (DTMS). The functions provided by a DTMS differ widely depending on the software, so it is important that you choose software suited to your needs.

● Connections with your computer

There are two ways to connect the SC-88 to your computer; using the MIDI connectors or the computer connector. If you use the MIDI connectors, you will need to obtain a computer interface board (adapter) that has MIDI connectors (such as the Roland Super MPU, etc.). If you use the SC-88 computer connector, you can use a special cable to connect it directly with the computer, but your software must be able to correspond to the serial port.

If you wish to connect your computer via the MIDI connectors, refer to p.5-4 (Connecting a computer via the MIDI connectors) for how to make connections. The following explanation will show how to make connections using the SC-88 computer connector.

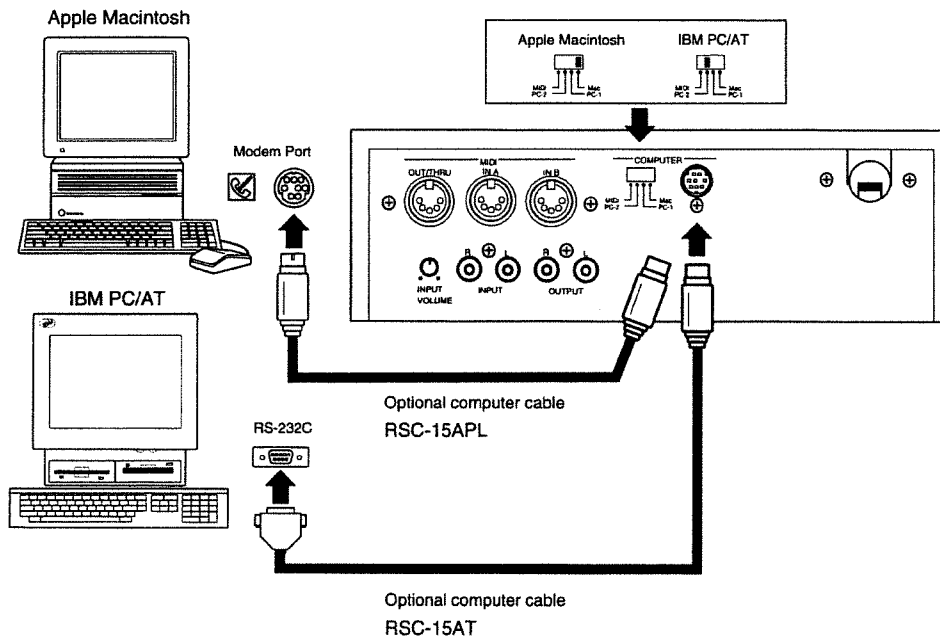

● Connections

1. Turn off the SC-88 power, and set the **COMPUTER** switch located on the back of the SC-88.

Note

The Computer switch will be validated when the power is turned off and then on after the setting has been made.

* The setting will depend on the type of computer you have and the software you use.

The PC-1 baud rate is 31.25K (bit/sec), and the PC-2 baud rate is 38.4K (bit/sec). Set the computer switch to the baud rate required by your MIDI application (software). Carefully read the manual for your software regarding the switch setting.

In general, set the switch to Mac for Macintosh series computers, and to PC-2 for IBM PC/AT series computers.

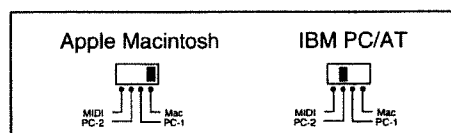

2. Connect the computer cable to the **RS232C** connector or modem port located on the back of your computer.

Types of computer cable

Macintosh series	RSC-15APL
IBM PC/AT series	RSC-15AT (This is a 9 pin cable. If you need a 25 pin cable, refer to the wiring diagram on p.7-5 and purchase an appropriate cable.)

3. Connect the other end of the computer cable to the **SC-88** computer connector (**COMPUTER**).
4. Turn on the SC-88 power.

Caution when using the SC-88 with the IBM PC/AT series

Even if the SC-88 computer connector is connected to your personal computer, it will not operate correctly if the software (MIDI application) is incompatible. Be sure to use software that is compatible with the serial port of the personal computer.

● Connecting a computer via the MIDI connectors

* Set the Computer select switch located on the back of the SC-88 to MIDI.

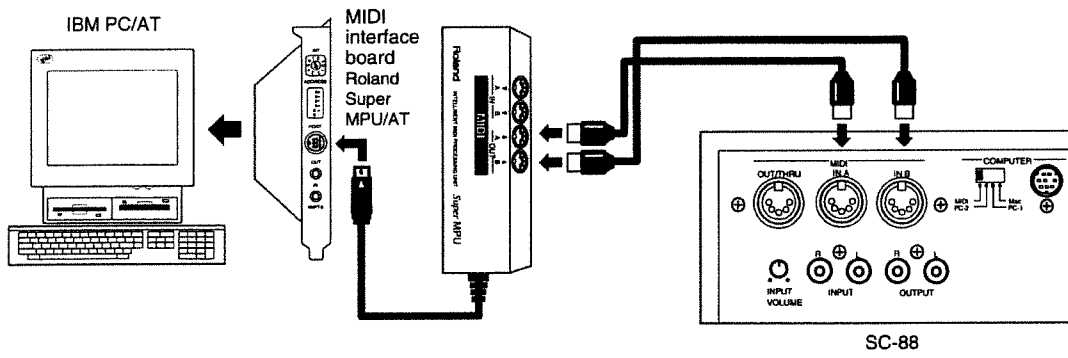
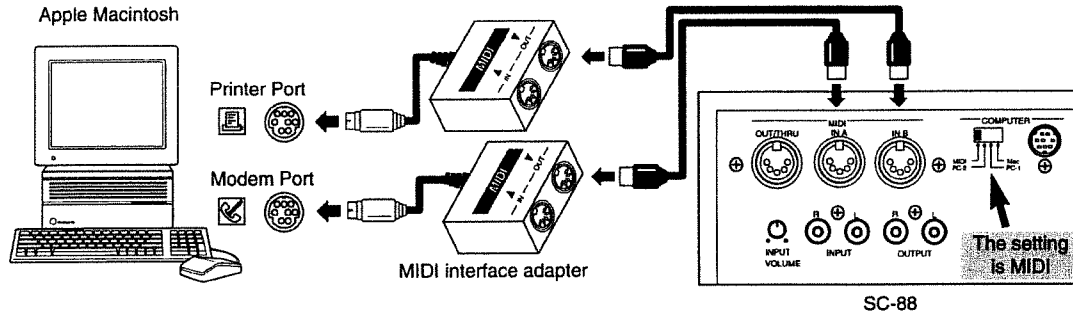

● MIDI data transfer with the computer

Depending on the setting of the computer switch, MIDI data flow will be different as follows (with the factory settings).

○ When the computer switch is set to PC-1, PC-2 or Mac

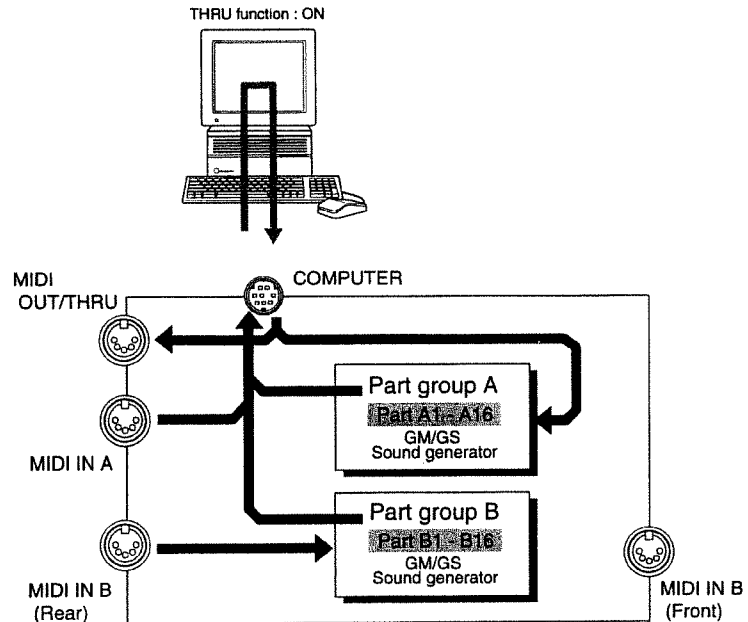

- * In order for data received at MIDI IN A to be sent to the sound generator section, the Thru function of the computer software must be turned on. When thru function is turned on, the data received at MIDI IN A will pass through the computer and be played by the sound generator section. When transmitting MIDI Exclusive data from the sound generator section via the SC-88's MIDI OUT/THRU connector, it is also necessary for thru function to be on.
- * Data received at MIDI IN B will not be sent to the computer connector, but will be passed directly to the sound generator section.
- * The number of sound generator Parts that can be controlled using the computer connector will depend on the software you are using. This means that if you are using the computer connector, you will not necessarily be able to play 32 Parts. Carefully read the operating manual for your software. Also be aware that although the SC-88 allows two connectors MIDI IN A and B to be used for 32 Part performance, this may be impossible to achieve depending on your software.

○ When the computer switch is set to MIDI

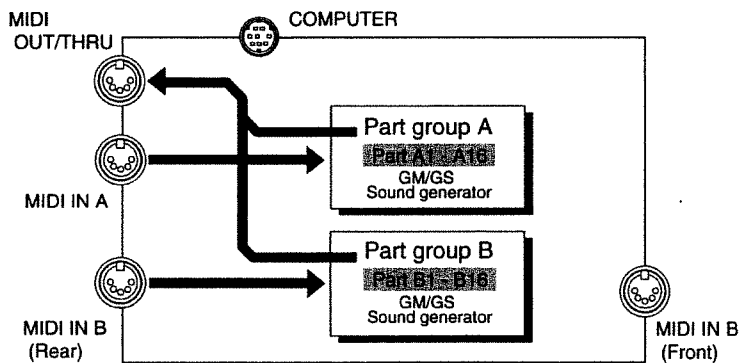

- * Be aware that when the computer switch located on the back of the SC-88 is set to MIDI, data will not be exchanged via the computer connector.
- * If you wish to use the MIDI IN B located on the front panel, you must make the appropriate settings for IN B Select (see p.6-10).
- * With the factory settings, MIDI OUT/THRU is set to function as MIDI OUT. If you wish to use it as MIDI THRU, set the MIDI OUT/THRU select switch (see p.6-11) to THRU.
- * Exclusive data address settings are explained on p.5-10.
- * With the factory settings, MIDI messages received at MIDI IN A are passed to Group A Parts, and MIDI messages received at MIDI IN B are passed to Group B Parts. In most situations there is no need to change this, but it is possible to change the MIDI signal flow as shown below (see p.6-10, 6-13).

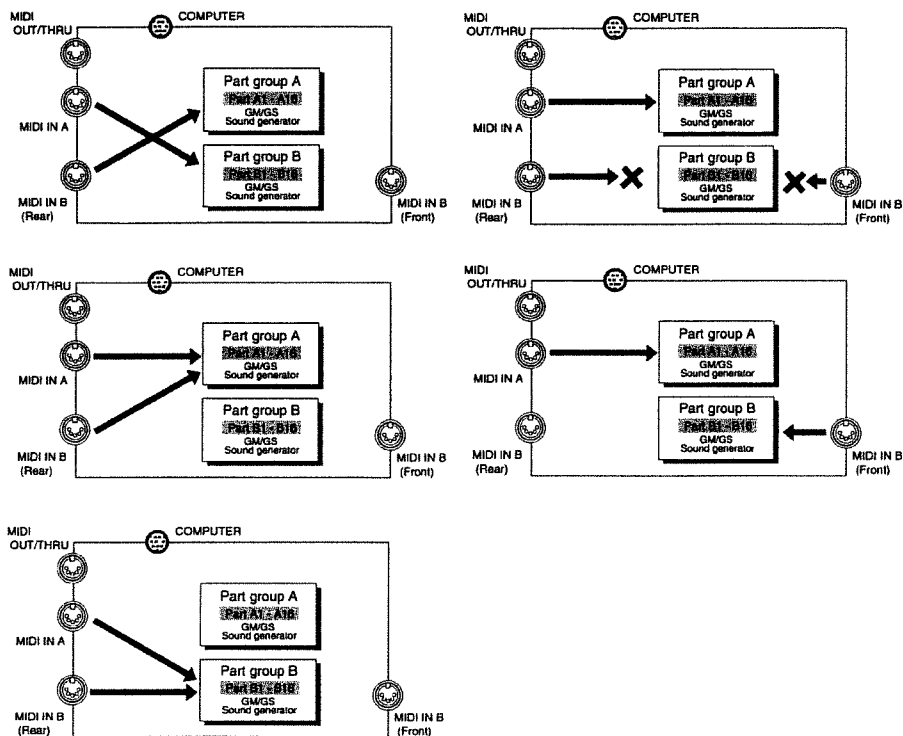

● Connecting another MIDI sound source to the SC-88

If you wish to connect another MIDI sound source to the SC-88's MIDI OUT/THRU connector, be aware of the following points.

○ When using another sound source to play data received at the computer connector

In this situation, set MIDI OUT/THRU Select (p.6-11) to OUT. Computer data received at the computer connector will be transmitted from the SC-88 MIDI OUT/THRU connector.

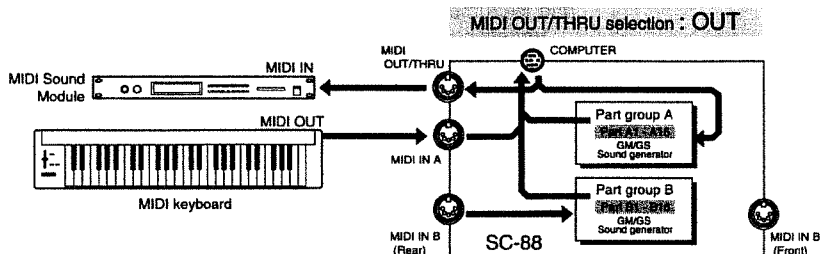

○ When using another sound source to play data received at MIDI IN A

In this situation, set MIDI OUT/THRU Select (p.6-11) to THRU. Data received at MIDI IN A will be transmitted just as it is from MIDI OUT/THRU.

* Data received at MIDI IN B will not be passed THRU even if THRU is selected. Regardless of the Input Mode setting (Input mode p.6-12), data from MIDI IN B will not be THRUed.

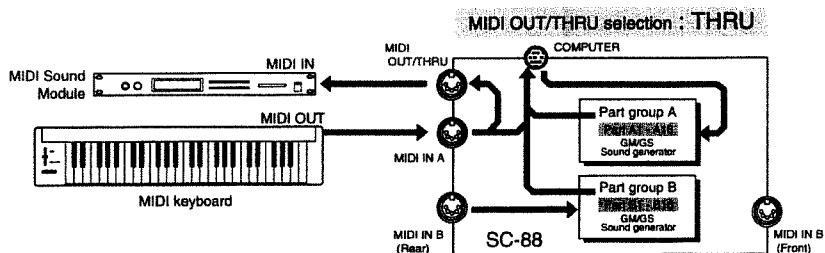

■ Using MIDI messages to select sounds

You can use a computer or sequencer to select sounds or drum sets for each part, as explained below.

By sending MIDI messages from a MIDI keyboard or sequencer, you can remotely select the sound (Instrument) for each Part. When you press a sound select button on a MIDI keyboard, a MIDI message selecting a sound will be transmitted (see p.1-4, 6-4).

You can also use your personal computer to select SC-88 sounds. You can specify sounds by inputting the Variation number and the Instrument number (see p.7-10) into your computer program, but depending on your software the way in which numbers are displayed may differ, so be aware of this. On the SC-88, Variation numbers begin with 0, and Instrument numbers begin with 1.

Variation numbers correspond to MIDI Bank numbers, and Instrument numbers correspond to MIDI Program numbers. It is usual for MIDI Bank numbers and Program numbers to begin from 1.

The relation between these numbers is shown in the following chart. Notice that the Variation numbers and the MIDI Bank numbers are one apart.

SC-88 display	: Variation number	0 — 127	Instrument number	1 — 128
MIDI message	: Bank number	1 — 128	Program number	1 — 128

- * MIDI Bank numbers have an upper (MSB) and lower (LSB) part. Each can specify a number 1 — 128, allowing you to specify $128 \times 128 = 16384$ banks. The upper part of the Bank number corresponds to the SC-88 Variation number. The lower part switches between SC-55 and SC-88 sounds. (MIDI Implementation, p.7-21).
- * For the relation between the sound names and program numbers of your MIDI keyboard, refer to the manual for your MIDI keyboard.
- * If you specify a sound number that the SC-88 does not have, there will be no sound. Refer to the instrument table on p.7-10 when selecting sounds.

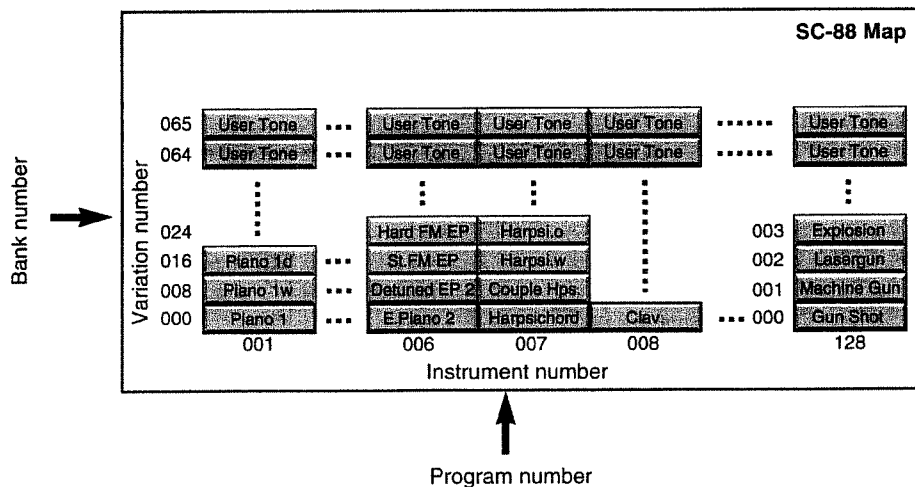

When creating MIDI messages on a sequencer or personal computer and transmitting them, use the following procedure.

1. The value of Control Change 0 : MIDI Bank Number (upper) (the SC-88 Variation number)
2. The value of Control Change 32 : MIDI Bank Number (lower)
3. Program Change value : MIDI Program Number (SC-88 instrument number)

1. and 2. are the Bank Select message. Bank Select messages are a type of Control Change message (see p.6-4).

For example if you wish to select the Instrument (Piano3w) of Variation 8, Instrument number 3, you would transmit the following data to the SC-88.

- (Expressed in decimal notation.)
1. The value of Control Change 0 : 8 (upper bank number 9; Variation number 8)
 2. The value of Control Change 32 : 0 (always leave this set to 0)
 3. Program Change value : 2 (Program number 3 : Instrument number 3)

* Note that the data actually transmitted as the Program number will be one less than the Program number. Also, the data actually transmitted as the MIDI Bank Select values will be one less than the bank number. In 1 and 2 above, upper bank number 9 (Variation number 8) is being specified.

- (The example above can be expressed in hexadecimal as follows.)
1. BnH 00H 08H
 2. BnH 20H 00H
 3. CnH 02H

* H indicates that the value is expressed as a hexadecimal number. Decimal 32 is written as hexadecimal 20H.
 * n indicates the MIDI channel.
 * Note that for MIDI channels and Instrument numbers, the number is one less than the channel or Instrument number. For example if you wish to select a sound on the Part receiving MIDI channel 4, n would be 3. If you wish to select instrument 3, the value in step 3 would be 2.

The SC-88 processes the lower part of the bank select message (LSB) as follows.

Least significant byte (LSB)

00H	The setting of the [SC-55 MAP] button is followed. If the front panel [SC-55 MAP] button is lit, SC-55 sounds will be selected, and if the button is dark, SC-88 sounds will be selected.
01H	SC-55 sounds will be selected, and the [SC-55 MAP] button will be lit.
02H	SC-88 sounds will be selected, and the [SC-55 MAP] button will be dark.

If we use the previous example of selecting the Piano3w sound, if we transmit

1. BnH 00H 08H
2. BnH 20H 02H
3. CnH 02H

to the SC-88, the SC-88 sound Piano3w will be selected. If in step 2 we transmitted BnH 20H 01H, the SC-55 sound Piano3w would be selected.

* When SC-55 sounds are being selected, a "" mark will be displayed at the left of the name.

PART	INSTRUMENT
A01	001 "Piano 1
LEVEL	PAN :
100	A :

● Using MIDI messages to select Drum Sets

You can select Drum Sets by transmitting MIDI Program Change messages from a MIDI keyboard or sequencer, in the same way as you can select Instruments. When a Program Change message is received, the Drum Set will change. Transmit a Program Change message on the channel being received by the Drum Part. With the factory settings, Part 10 is the Drum Part (MIDI receive channel:10). On the SC-88, Drum Set numbers correspond to program numbers (*see* p.7-16).

* Set the note numbers of the rhythm data being played back to match the note numbers of the SC-88 Drum Set you are using (*see* p.7-16).

Drum Set name and Drum Set number (Program number)



Exclusive data addresses

○ Receiving exclusive data

As listed in "MIDI Implementation" (*see* p.7-26, 7-29), the address of MIDI exclusive data (GS format) is defined in units of 16 Parts. In other words, starting from address 40 00 00 are the parameters for 16 Parts. The SC-88 has data for another 16 Parts, making a total of 32 Parts. For this reason, the SC-88's MIDI exclusive data format expands the addressing, and places the remaining 16 Parts at starting address 50 00 00.

In the same way as with channel messages, exclusive data received at MIDI IN A is passed to Group A Parts, and exclusive data received at MIDI IN B is passed to Group B Parts. In other words, exclusive data for the 32 Parts is received using two MIDI IN connectors. If this is done, each MIDI IN receives exclusive data for 16 Parts, so it is not necessary to split up the data into addresses 40 00 00 and 50 00 00.

However it is also possible for the SC-88 to receive exclusive data for all 32 Parts at a single MIDI IN. In this case it is necessary to use address 50 00 00. For example, the data at starting address 40 00 00 will be passed to Group A Parts, and the data at starting address 50 00 00 received at the same MIDI IN will be passed to Group B Parts. In other words, using starting address 50 00 00 means that the data will be passed to the Parts of the other Group than the MIDI IN that the data was received at.

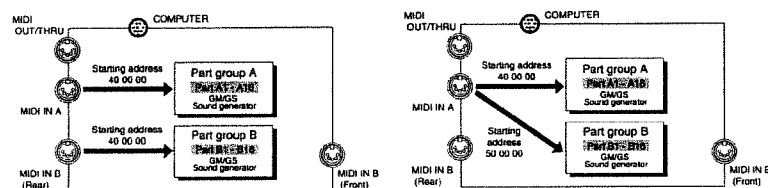

Only in the case of Exclusive data, the System parameter Input Mode (*see* p.6-12) has no effect on the way in which data is passed from the two MIDI IN connectors to the Parts.

○ Transmitting exclusive data

Since the SC-88 has only one MIDI OUT, the exclusive data transmitted is sent using the two address areas of 40 00 00 and 50 00 00. User sound data is located at starting areas of 20 00 00.

* Be aware that exclusive data will be not transmitted from MIDI OUT connector if the MIDI OUT/THRU select (*see* p.6-11) is set to THRU.

Chapter 6

MIDI and the SC-88

■ About MIDI

MIDI stands for Musical Instrument Digital Interface. MIDI devices can transmit musically related data such as performance data or data to select sounds. Since MIDI is a world-wide standard, musical data can be sent and received between devices even if they are of different types and were made by different manufacturers. In the MIDI standard, data describing a musical performance such as "play a note" or "press the pedal" are transmitted as MIDI messages.

As long as you are using the SC-88 to simply play commercially available music data or to provide sound for game software, it is not necessary to know about MIDI. Simply follow the instructions in the manual for your music data playback device (MIDI player) or your software.

The explanation that follows will help you use MIDI to control the SC-88 in greater detail.

● How MIDI messages are transmitted and received

First we will briefly explain how MIDI messages are transmitted and received.

MIDI connectors

MIDI messages are transmitted and received using three types of connector. Connect MIDI cables to these connectors as appropriate for your setup.

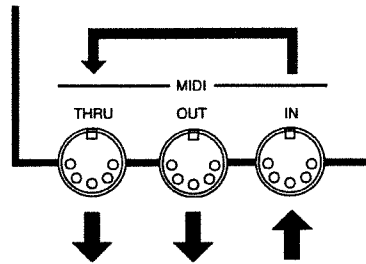

to another MIDI device from another MIDI device

MIDI IN : This connector receives messages from another MIDI device.

MIDI OUT : This connector transmits messages from the SC-88.

MIDI THRU : This connector retransmits the messages received at MIDI IN.

- * It is possible to use MIDI THRU to connect two or more MIDI devices, but in practice the limit is 5 units. This is because as the signal path becomes longer, the signal deteriorates and the messages can no longer be received correctly.
- * On the SC-88, MIDI THRU and MIDI OUT share the same connector. The MIDI OUT/THRU Select switch (see p.6-11) determines which function the connector will have.



● MIDI channels and multi-timbral sound modules

MIDI transmits a wide variety of performance data over a single MIDI cable. This is made possible by MIDI channels. MIDI channels allow specific data to be selected out of a large amount of data. The concept is similar to the idea of TV channels. By changing the channel of a TV receiver you can view the programs of different stations. By setting the channel of the receiver to match the channel of the transmitter, you can receive only the program you wish to watch. In the same way, MIDI allows you to receive data only when the channel of the receiver matches the channel of the transmitter.

The cable from the antenna carries the TV signals from many broadcast stations.

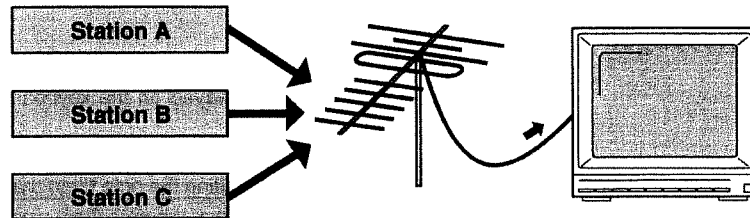

The TV is set to the channel of the station you wish to watch.

MIDI uses sixteen channels, numbered 1 — 16. Music data is received when the transmit channel of the transmitting device matches the receive channel of the receiving device. If you make MIDI channel settings as follows, only sound source B will sound when you play the keyboard, and sound source A will not sound. This is because sound source B matches the transmit channel of the keyboard, but sound source A's channel does not match (Fig.1).

Conversely, if you set the transmit channel of the keyboard to match sound source A, sound source A will sound (Fig.2).

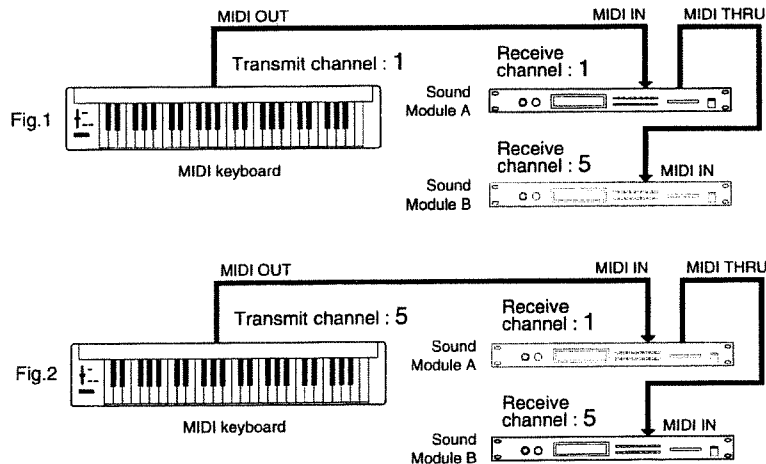

Since the SC-88 has two MIDI IN connectors, it can receive a total of 32 channels simultaneously. By using 32 channels you can play ensembles of 32 Parts (☞ p.2-8). Sound sources such as the SC-88 which are able to simultaneously play many parts are called multi-timbral sound modules. Timbre is a word meaning sound.

The SC-88 has two types of Parts: Normal Parts and Drum Parts (☞ p.2-13). Normal Parts are used to play melody or bass lines. On GM/GS sound sources, the Drum Part uses channel 10.

■ MIDI messages that can be received by the SC-88

MIDI uses many different types of message to transmit musical performance data, and there are many types of MIDI message. For example, information indicating "which key was played how strongly" is transmitted as a Note message.

The way that a device responds when it receives each type of MIDI message (i.e., how it produces sound, etc.) will depend on the specifications of that device. This means that if the receiving device is not able to perform the function requested by the incoming message, the musical result will not be what you expected.

The main types of MIDI message received by the SC-88 are as follows.

* MIDI messages for which reception capability is required by the GM system (level 1) are marked by a ☆ sign.

○ Note messages ☆

These messages convey notes played on the keyboard. They include the following information.

Note number : a number indicating the note (key) that was pressed or released

Note on : data indicating that the note (key) was pressed

Note off : data indicating that the note (key) was released

Velocity : a number indicating how strongly the note (key) was pressed

Note numbers are a number from 0 — 127 which indicate the keyboard key position, with middle C (C4) as note number 60.

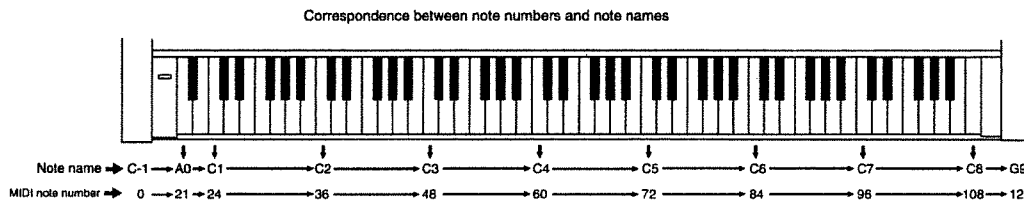

○ Pitch bend ☆

This message conveys the position of the bender lever (or pitch bend wheel). The pitch will change when this message is received.

○ Bank Select (Control Change number 0 and 32)

○ Program Change ☆

These messages are used to select sounds. Sounds are selected by a Program numbers 1 — 128. On the SC-88, these messages will select sounds (Instruments). By using Bank Select messages (which are a type of Control Change message), an even wider variety of sounds can be selected (see p.5-8).

○ Control Change

These messages control parameters such as modulation and pan. The function of the message is determined by its Control Change number.

Modulation (control change number 1) ☆

This message controls vibrato.

Volume (control change number 7) ☆

This message controls the volume of a Part. When this message is received the volume of a Part will change.

Expression (control change number 11) ☆

This message conveys volume changes. It can be used to add expression during a song.

** The volume of a Part will be affected both by Volume messages (control change 7) and by Expression messages (control change 11). If a value of 0 is received for either of these messages, the Part volume will be 0 and will not rise even if the other message is sent with a higher value. Be aware of this.*

Pan (control change number 10) ☆

This message controls the stereo position of a Part. (✎ p.2-12, 22)

Hold (1) (control change number 64) ☆

This message conveys the up/down movements of the damper pedal, causing the currently sounding notes to be sustained. When a message of Hold On is received, notes will be sustained. In the case of decay-type instruments such as a piano, the sound will decay gradually until a Hold Off message is received. In the case of sustain-type instruments such as an organ, the sound will continue sustaining until a Hold Off message is received.

Sostenuto (control change number 66)

The sostenuto pedal on a piano sustains only the notes which were already sounding at the moment the pedal was pressed. The Sostenuto message conveys the movement of this pedal. When Sostenuto On is received, only the notes which were already on at that moment will be sustained. In the case of decay-type instruments such as a piano, the sound will decay gradually until a Sostenuto Off message is received. In the case of sustain-type instruments such as an organ, the sound will continue sustaining until a Sostenuto Off message is received.

Soft (control change number 67)

The soft pedal on a piano softens the tone during the time the pedal is pressed. The Soft message conveys the movement of this pedal. When Soft On is received, the cutoff frequency will be lowered, causing a softer sound. When Soft Off is received, the previous sound will return.

Reverb Send Level (control change number 91)

This message adds a reverb effect to the Part (Reverb Level ✎ p.3-7).

Chorus Send Level (control change number 93)

This message adds a chorus effect to the Part (Reverb Level ✎ p.3-8).

Delay Send Level (control change number 93)

This message adds a delay effect to the Part (Reverb Level ✎ p.3-9).

Portamento (control change number 65)
Portamento Time (control change number 5)
Portamento Control (control change number 84)

Portamento is an effect that creates a smooth change in pitch between the previously played note and the newly played note. When a Portamento message is received, the portamento effect will be turned on or off. Portamento Time controls the speed of the pitch change. Portamento Control specifies the Source Note number (the previously played note).

RPN LSB, MSB (control change number 100/101) ☆

Data Entry (control change number 6/38) ☆

Since the function of the RPN (Registered Parameter Number) is defined in the MIDI specification, this message can be used between devices of different types. The RPN MSB and LSB messages specify the parameter which is to be modified, and then Data Entry messages can be used to modify the value of that parameter. RPN can be used to adjust Pitch Bend Sensitivity, Master Coarse Tune, and Master Fine Tune.

* *The values modified using RPN messages will not be initialized even if Program Change messages etc. are received to select other sounds.*

NRPN LSB, MSB (control change number 98/99)

Data Entry (control change number 6/38)

NRPN (Non-registered Parameter Number) messages can be used to modify the values of sound parameters unique to a particular device. The NRPN MSB and LSB messages specify the parameter which is to be modified, and then Data Entry messages can be used to modify the value of that parameter.

Since the GS format defines the function of several NRPN messages, GS compatible application programs can use NRPN messages to modify sound data parameters for Vibrato, Cutoff Frequency, Resonance, and Envelope values.

* *The values modified using NRPN messages will not be initialized even if Program Change messages etc. are received to select other sounds.*

* *With the factory settings, the SC-88 will ignore NRPN messages. After a GS Reset message is received, NRPN messages will be received. You can also turn Rx.NRPN on (NRPN Receive Switch, p.6-16) either from the front panel or by using exclusive messages, so that NRPN messages will be received.*

○ **Aftertouch (Channel Pressure only) ☆**

Aftertouch is a message which conveys the pressure applied to the keyboard after playing a note, so that this information can be used to control various aspects of the sound. There are two types of aftertouch message; Polyphonic Key Pressure which is transmitted separately for each note, and Channel Key Pressure which is transmitted as one value that affects all notes on the specified MIDI channel.

* *With the factory settings, Aftertouch messages will have no effect when received by the SC-88. In order for Aftertouch messages to do something, you need to set Aftertouch-related parameters. ( p.2-16).*

○ All Sounds Off

This message completely turns off the sound of all currently-sounding notes. The sound of the specified channel will be forcibly turned off.

○ All Notes Off ☆

This message causes a Note Off to be sent to each note of the specified channel that is currently on. However if Hold 1 or Sostenuato are on, the sound will continue until these are turned off.

○ Reset All Controllers ☆

This message returns controller values to their initial settings. The following controller values for the specified channel will be reset to their initial values.

Controller	Initial value
Pitch Bend	0 (center)
Polyphonic Key Pressure	0 (minimum)
Channel Pressure	0 (minimum)
Modulation	0 (minimum)
Expression	127 (maximum)
Hold	0 (off)
Portamento	0 (off)
Soft	0 (off)
Sostenuto	0 (off)
RPN	number unset
NRPN	number unset

* Parameter values that were modified using RPN or NRPN will not change even when a Reset All Controller message is received.

○ Active Sensing

This message is used to check for broken MIDI connections, such as MIDI connectors that have been pulled out or MIDI cables that have been broken. The SC-88 transmits Active Sensing messages from MIDI OUT at specific intervals. Once an Active Sensing message is received at MIDI IN, Active Sensing monitoring will begin, and if an Active Sensing message fails to arrive for more than 420 msec, it is assumed that the cable has been disconnected. If this happens, all currently sounding notes will be turned off, the same procedure will be executed as if a Reset All Controllers message was received, and Active Sensing monitoring will stop.

○ System Exclusive messages

Exclusive messages are used to control functions which are unique to specific devices. Although Universal System Exclusive messages can be used even between devices of different manufacturers, most exclusive messages cannot be used between devices of different types or different manufacturers.

In order to recognize the device for which the data is intended, Roland exclusive messages contain a manufacturer ID, device ID and model ID.

The SC-88 exclusive messages use two model IDs; 42H for GS format, and 45H for SC-55 (155). The two numbers are used depending on the parameter you wish to modify. Be aware that if the appropriate ID number is not used, data will not be transferred. (☞ p.6-9)

GM System On ☆ (Universal System Exclusive)

When GM System On is received, the unit will be set to the basic GM settings. Also, NRPM Bank Select messages will no longer be received after GM System On is received. The beginning of song data bearing the GM logo contains a GM System On message. This means that if you playback the data from the beginning, the sound generator device will be automatically initialized to the basic settings.

GS Reset (GS Format System Exclusive)

When GS Reset is received, the unit will be set to the basic GS settings. Also, NRPM messages specified in the GS format can be received after GS Reset is received. The beginning of song data bearing the GS logo contains a GS System Reset message. This means that if you playback the data from the beginning, the sound generator device will be automatically initialized to the basic settings.

Master Volume (Universal System Exclusive)

This is an exclusive message common to all MIDI devices that controls the master volume of all Parts.

Other exclusive messages

The SC-88 can receive GS format exclusive messages (model ID 42H) that are common to all GS sound generators. The SC-88 can also use exclusive messages (model ID 45H) that are especially for the SC-88 (155). Exclusive messages can be used to store SC-88 settings or to make fine adjustments to parameters.

For details of the exclusive message transmitted and received by the SC-88, refer to the explanation on p.7-21 and following.

● About MIDI implementation charts

MIDI allows many different types of device to be connected, but in some cases there will be types of message which cannot be conveyed meaningfully. For example if you wish to use keyboard aftertouch to control the sound but the sound generator connected to the keyboard does not receive aftertouch messages, you will not get the musical result you intend. In this way, only messages that are used by both devices will actually be conveyed.

The MIDI specification requires that the owner's manual for each MIDI device include a "MIDI Implementation Chart" (☞ p.7-37) that shows the types of MIDI message which are actually transmitted and received by a device. Place the transmit column of the transmitting device's implementation chart side by side with the receive column of the receiving device's implementation chart. Messages which are marked as "O" in both charts can be conveyed successfully. If either chart shows a "X" for a certain type of message, that message cannot be conveyed.

For your reference, the data format for exclusive messages and other details of the SC-88 MIDI implementation are given on p.7-21 and following.

● Device ID number settings

The Device ID number is an identification number used when transmitting and receiving exclusive messages (see p.6-8). The SC-88 receives exclusive messages only if its own device ID number matches the device ID number of the message. This means that if you wish to transmit exclusive messages between devices, you must make sure that their device ID numbers match.

The device ID number is a number from 1 — 32. With the factory settings the number is 17.

- * If you wish to playback Roland SMF music data, be sure that the device ID number is set to 17. If it is not, playback will not be correct.
- * It is not possible to specify the device ID number separately for individual Parts.

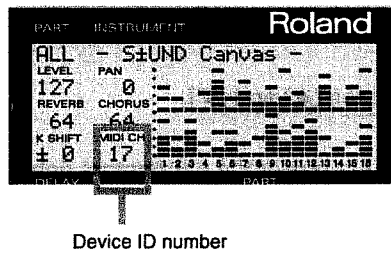

Device ID number

How to make settings

1. Press [ALL] to make the button indicator light.
2. Use MIDI CH [◀] [▶] to modify the device ID number.

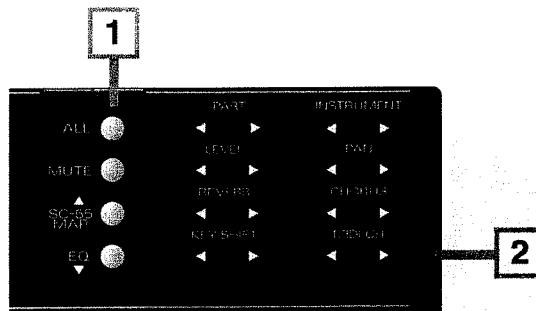

■ MIDI message routing settings and switches

The SC-88 provides various parameters that determine how incoming MIDI messages are passed to the Parts. For some types of MIDI message, a switch is provided to turn reception on or off. These parameters can be classified as "Parameters which apply to all Parts" or "Parameters which can be set individually for each Part."

[1] Switches which apply to all Parts (A)

IN B Select	(IN B Select) Front/Rear
OUT/THRU	(MIDI OUT/THRU Select) OUT/THRU
Input Modes	(Input Modes) Standard, X-connect, Merge → A, Merge → B, A only
Rx Sys Mode	(System Mode Set Receive switch) On, Off

● Procedure

1. Simultaneously press [▲] and [▼].
2. Use [▲] [▼] to select one of the parameters listed below.

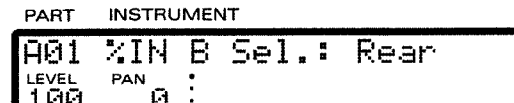

3. Use INSTRUMENT [◀] [▶] to set the value.
4. When you have set the value, simultaneously press [▲] and [▼] to end the procedure.
5. Turn on the power again. (Except when you have selected Rx System Mode.)

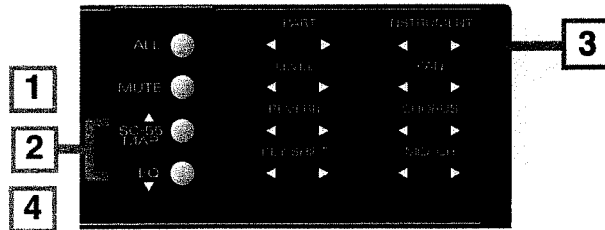

● How each parameter works

○ IN B Select (IN B Select) Front/Rear

The SC-88 has two MIDI IN B connectors, one on the front panel and another on the rear panel. If the IN B Select parameter is set to Front, the front panel MIDI IN B can be used. If the IN B Select parameter is set to Rear, the rear panel MIDI IN B can be used. It is not possible to use both the front and the rear MIDI IN B connectors simultaneously.

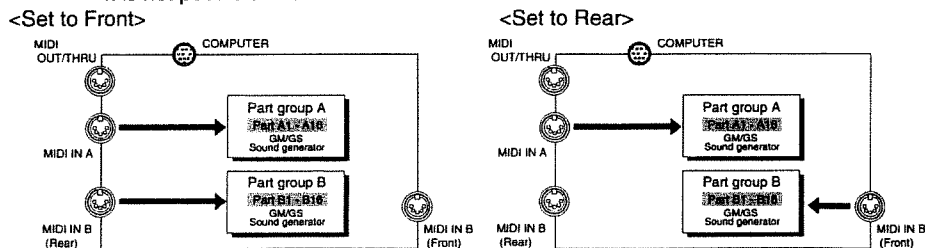

○ **OUT/THRU (MIDI OUT/THRU Select) OUT/THRU**

The MIDI OUT/THRU connector on the rear panel of the SC-88 can function either as a MIDI OUT or a MIDI THRU. When the OUT/THRU select is set to OUT the connector will function as MIDI OUT, and when set to THRU it will function as MIDI THRU.

If THRU is selected, data received at MIDI IN A will be retransmitted from the MIDI OUT/THRU connector. Data received at MIDI IN B will never be "thru-ed", regardless of the THRU setting, and regardless of the setting (Type 1-4) for Input Mode (see p.6-12).



If OUT is selected, exclusive data (see p.6-8) or data received at the computer connector can be transmitted from the MIDI OUT/THRU connector.

When the COMPUTER switch is set to MIDI

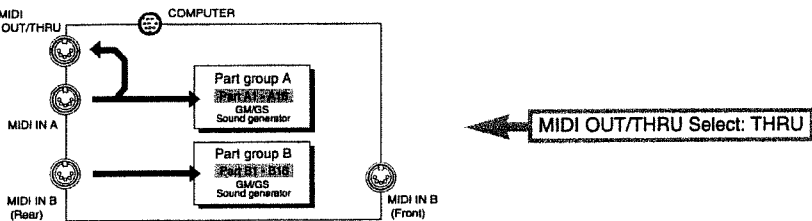
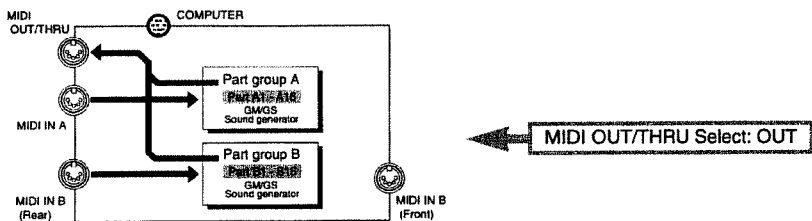

When the COMPUTER switch is set to PC-1, PC-2 or Mac

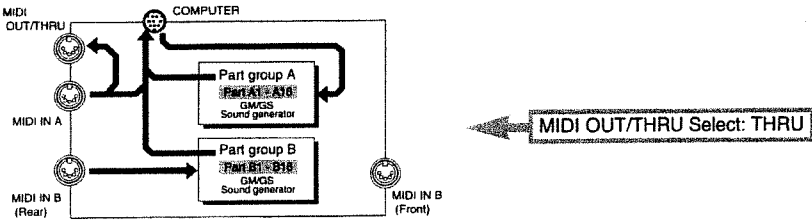
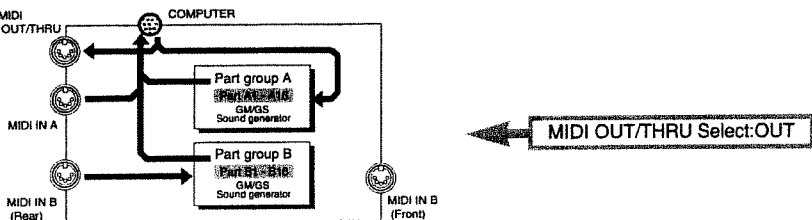

○ Input Modes

Standard, X-connect, Merge → A, Merge → B, A only

With the factory settings, MIDI messages received at MIDI IN A are passed to Group A Parts, and MIDI messages received at MIDI IN B are passed to Group B Parts. In normal circumstances, there is no need to change the standard setting, but it is also possible to change the MIDI signal in the following.

Standard

MIDI messages received at MIDI IN A are passed to Group A Parts, and MIDI messages received at MIDI IN B are passed to Group B Parts. Standard is the factory setting.

X-connect (Cross connect)

This reverses the handling of Standard. MIDI messages received at MIDI IN A are passed to Group B Parts, and MIDI messages received at MIDI IN B are passed to Group A Parts.

Merge → A

MIDI messages received at either MIDI IN A or MIDI IN B are sent to Group A Parts. MIDI messages are not sent to Group B Parts, so they will not sound. For example, you might use this setting when you wish to play Group A Parts simultaneously from a MIDI keyboard and from a MIDI sequencer.

Merge → B

This reverses the handling of Merge → A. MIDI messages received at either MIDI IN A or MIDI IN B are sent to Group B Parts. MIDI messages are not sent to Group A Parts, so they will not sound.

A only

When using the Roland Super MPU (MIDI Processing Unit: two MIDI OUTs), some software will transmit the same data to both of the SC-88's MIDI IN connectors. This will cause two Parts to sound in unison, causing an unnatural effect. In such a case, do not use both MIDI INs. Either disconnect one of the MIDI cables, or use the preceding procedure to set to A only. When A only, data received at MIDI IN B will be ignored.

- * *Be aware that if the computer switch on the rear panel of the SC-88 is set to either PC-1, PC-2 or Mac, MIDI data received at MIDI IN A will not be sent to the Parts (the sound generator), but will be sent through the computer connector to the computer (see p.5-5).*
- * *The data sent from the computer through the computer connector will be treated as received from MIDI IN A, and will be passed to the various Parts according to the Input Modes setting.*

○ Rx Sys Mode (System Mode Set Receive Switch): On/Off

The selection of Single Module Mode or Double Module Mode (p.4-16) is called the System Mode. The Rx Sys Mode setting is the receive switch for MIDI messages (System Mode Set p.7-24) that select the System Mode. If Rx Sys Mode is turned Off, the mode will not change even if System Mode Set messages are received. If Rx Sys Mode is turned On, the mode will change.

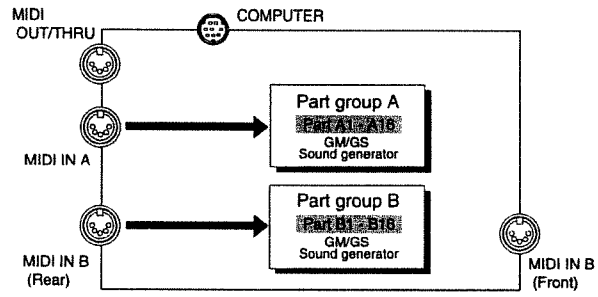

Standard

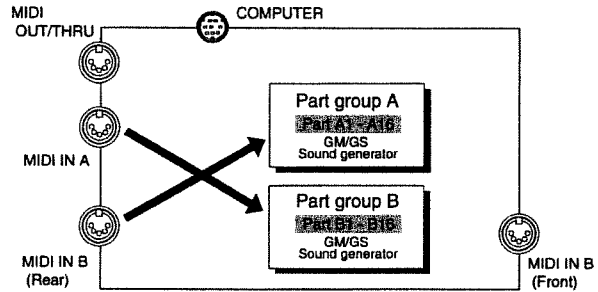

X-connect
(Cross connect)

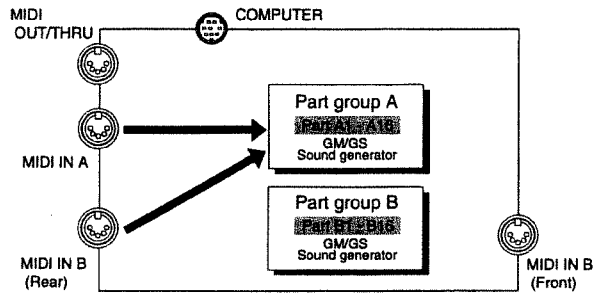

Merge → A

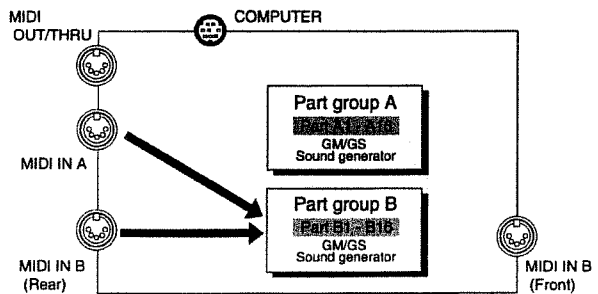

Merge → B

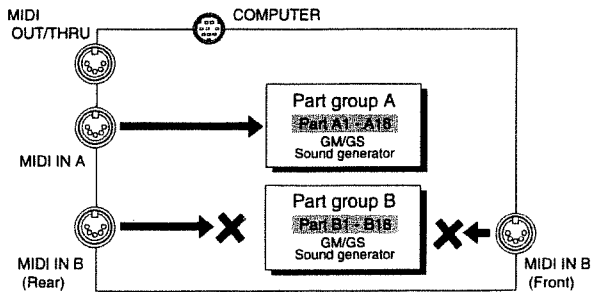

A only

[2] Switches which apply to all Parts (B)

Mute Lock	(Mute Lock) On/Off
EQ Lock	(Equalizer Lock) On/Off
Rx GM On	(GM System On Receive Switch) On/Off
Rx GS On	(GS Reset Receive Switch) On/Off

● Procedure

1. Press [ALL] to make the button indicator light.
2. Simultaneously press both the PART [◀] [▶] buttons.
3. Press either [▲] or [▼] to select the parameter you wish to set.

```
PART  INSTRUMENT
ALL  >Rx GS Reset: On
LEVEL PAN  :
1000  0  :
```

4. Use the INSTRUMENT [◀] [▶] buttons to set the value.

```
PART  INSTRUMENT
ALL  >Rx GS Reset: Off
LEVEL PAN  :
1000  0  :
```

5. When you finish making settings, simultaneously press both the PART [◀] [▶] buttons to exit the procedure.

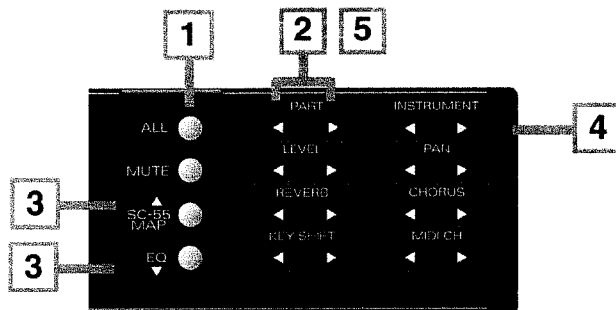

● How each switches works

○ Mute Lock (Mute Lock) On/Off

When you once again playback a song that was previously played back, Mute settings (☞ p.2-12, 22) are sometimes defeated. This is because the beginning of the song data contains a message that causes the SC-88 to reset to initial values (GM System On / GM Reset p.6-8). If Mute Lock is turned on, muting will not be turned off even when GS Reset or GM System On is received, so there will be no need for you to remake mute settings. This is convenient when, for example, you are repeatedly playing back a song with a certain Part muted so that you can play that Part yourself. There are two types of muting; All Mute which mutes all Parts and Part Mute which mutes specific Parts.

○ EQ Lock (Equalizer Lock) On/Off

When a GS Reset or GM System On message is received, the equalizer settings will be restored to the factory settings (initialized). If EQ Lock is turned on, this will not occur.

○ Rx GM On (GM System On Receive Switch) On/Off

○ Rx GS On (GS Reset Receive Switch) On/Off

GM System On and GS Reset (☞ p.6-8) are MIDI exclusive messages that are included in the beginning of song data bearing the GM or GS logo. When song data is played back from the beginning, these messages cause the sound generator parameters to be reset to basic values so that playback will be correct. Thus, when playing back song data bearing the GM or GS logo, you should leave these parameters on. If these parameters are turned off, GM System On and GS Reset messages will be ignored.

[3] Switches which can be set individually for each Part

○ Rx Bank [SELECT] (Bank Select Receive Switch) On/Off

To remotely select SC-88 sounds from another MIDI device, you can send Bank Select messages and Program Change messages to the SC-88. If Rx Bank Sel is turned on, these MIDI messages can select Variation sounds (see p.2-4) and User sounds (see p.4-2). If this parameter is turned off, MIDI messages cannot select Variation sounds or User sounds (they will select Capital sounds). If this parameter is turned off, a "-" will be displayed between the instrument number and the sound name.

For details on using MIDI messages to select sounds, refer to p.5-8.

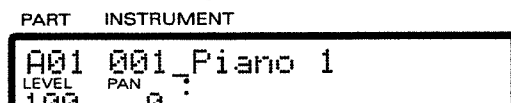

○ Rx NRPN (NRPN Receive Switch) On/Off

NRPN (Non-registered Parameter Number see p.6-6) messages allow you to modify vibrato, filter and envelope values (see p.2-10) via MIDI. If Rx NRPN is on, these sound parameters can be modified by MIDI messages. If Rx NRPN is off, this will not be possible.

- * When GM System On is received, Bank Select Receive Switch and NRPN Receive Switch will be turned off.
- * When GS Reset is received, Bank Select Receive Switch and NRPN Receive Switch will be turned on.

● Procedure

1. Make sure that the [ALL] indicator is dark.
If it is lit, press the [ALL] button to turn it off.
2. Simultaneously press both the PART [◀] [▶] buttons.
3. Use PART [◀] [▶] to select the Part whose setting you wish to modify.
4. Press [▲] or [▼] to select one of the parameters listed below.

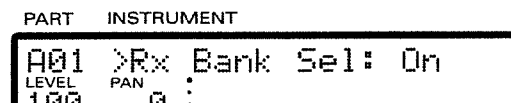

5. Use INSTRUMENT [◀] [▶] to turn on or off.
6. When you finish making settings, simultaneously press both the PART [◀] [▶] buttons to end the procedure.

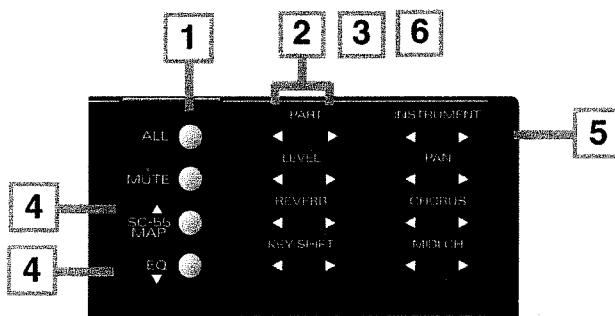

■ The General MIDI System and GS Format

● What is the General MIDI System?



The General MIDI System is a universal set of specifications for sound generating devices which has been agreed upon by both the Japanese MIDI Standards Committee and the American MMA (MIDI Manufacturer's Association). These specifications seek to allow for the creation of music data which is not limited to equipment by a particular manufacturer or to specific models.

The General MIDI System defines things such as the minimum number of voices that should be supported, the MIDI messages that should be recognized, which sounds correspond to which Program Change numbers, and the layout of rhythm sounds on the keyboard. Thanks to these specifications, any device that is equipped with sound sources supporting the General MIDI System will be able to accurately reproduce General MIDI Scores (music data created for the General MIDI System), regardless of the manufacturer or model.

● What is the GS Format?





The GS Format is a standardized set of specifications for Roland's sound sources which defines the manner in which multi-timbral sound generating units will respond to MIDI messages. The GS Format also complies with the General MIDI System. The GS Format also defines a number of other details. These include unique specifications for sounds and the functions available for Tone editing and effects (chorus and reverb), and other specifications concerning the manner in which sound sources will respond to MIDI messages.

Any device that is equipped with GS Format sound sources can faithfully reproduce GS Music Data (music data created under the GS Format).

This product supports both General MIDI and GS. Song data which carries either of these logos can be accurately reproduced.

When you play the GM Score data, be sure to set the GM System On Switch to ON and the Exclusive Receiving Switch to ON ( P.6-14).

When you play Roland SMF Music data, be sure to set the Device ID number ( p.6-9) to 17, the GS Reset Receiving Switch to ON and the Exclusive Receiving Switch to ON ( p. 6-14).

The default settings are as above.



Chapter 7

Appendix

■ Troubleshooting

If the SC-88 does not function in the way you expect, first check the following points. If this does not resolve the problem, consult your dealer or a nearby Roland Service Station (listed at the end of this manual).

- *If a message appears during operation, consult the following section "If a message appears."*
- *If performance is incorrect when playing back song data carrying the GM/GS logo, check the following points.*
 - *That the Device ID is set to 17 ([☞](#) p.6-9)*
 - *That the GM System On / GS Reset Receive Switch ([☞](#) p.6-14) is turned on**The above settings are made when the SC-88 is shipped from the factory.*

● **Cannot turn the power on**

- Is the power cable correctly plugged into an outlet?

● **No sound**

- Is the power turned on for the other devices connected to the SC-88?
- Is the volume knob turned all the way down?
- Have you incorrectly connected the MIDI IN and OUT connectors? ([☞](#) p.1-2)
- Can you hear sound through headphones? (Try using the Preview function [☞](#) p.1-5.) If you can hear sound through headphones, the problem may be that the audio cable transmitting the sound to the other devices is broken or incorrectly connected, or that there is a problem with your mixer/amp/speaker system.
- Does the bar indicator in the display move? Are all dots in the bottom row of the bar display off? If they are all off, Mute is turned on. Turn Mute off. ([☞](#) p.2-10, 2-21)
- Is the overall volume for all parts turned down? ([☞](#) p.2-21)
- Has the Expression pedal etc. on a connected MIDI device turned the volume down?
- Is the rear panel Computer switch set to the correct position for the software you are using? ([☞](#) p.5-2) After changing the position of the Computer switch you must turn on the SC-88 power once again.

● **A specific Part does not sound**

- Is the lowest dot in the bar display off? Parts for which this dot is off have been muted. Turn Mute off. ([☞](#) p.2-10)
- Is the volume level of the Part turned down? ([☞](#) p.2-10)
- Does the MIDI Receive channel of the Part match the MIDI Transmit channel of the connected MIDI device? ([☞](#) p.2-7)

● **A specific keyboard area does not sound**

- Has the Keyboard Range been set? ([☞](#) p.2-14)

● **Sound is heard but the bar indicator does not move**

- Are you receiving MIDI messages at MIDI IN B and viewing Part information for Group A? If so, press the PART [◀] [▶] buttons to display the Parts of Group B. If you press the [ALL] button to make [ALL] light, Part information for both Groups A and B will be displayed.

● **Cannot select the desired sound**

- Are you sending an incorrect Program number? ([☞](#) p.5-8, 5-10)

- **Sound is distorted**

- If a specific sound or Part is distorted, lower the volume level of that Part. ([p.2-10](#))
- If all sounds are distorted, lower the overall volume level of all Parts ([p.2-21](#)), or use the Volume knob to lower the volume level.

- **Pitch is incorrect**

- Is the pitch of a specific Part incorrect? ([p.2-13](#))
- Is the pitch of all Parts incorrect by a semitone or more? ([p.2-21](#))
- Is the pitch of a specific Part incorrect by a semitone or more? ([p.2-10](#))
- Has a MIDI Pitch Bend message been received to change the pitch? Return the pitch bend lever or wheel to the central position. Or, transmit a Pitch Bend message with the central value (40 00H).

- **Sound is wrong**

- Have you selected another sound after modifying sound parameter settings (filter, etc.)? Restore all sound parameter settings to a value of 0. ([p.2-17](#))

- **Sounds are interrupted**

- If you attempt to play more than 64 voices at once, sounds will be interrupted. ([p.2-9](#))
- Is the same data being sent simultaneously to MIDI IN A and MIDI IN B? ([p.6-12](#))

- **Able to play only from either MIDI IN A or MIDI IN B**

- Make sure that the Input mode (Input mode) is set to Standard. ([p.6-12](#))
- Is the Input mode (Input mode) set to A Only? ([p.6-12](#))

- **Exclusive messages are not received**

- Does the Device ID number of the transmitted exclusive message match the Device ID number of the SC-88? ([p.6-9](#))

- **The SC-88 does not transmit MIDI data**

- If you wish to transmit SC-88 data via the Computer connector, set the Computer switch to PC-1, PC-2 or Mac, depending on the software you are using. ([p.5-2](#))
- When the rear panel Computer switch is set to MIDI, the SC-88 will not transmit data from the Computer connector. In this case, data will be transmitted from the MIDI OUT/THRU connector.
 - When the MIDI OUT/THRU select switch is set to THRU, data received at MIDI IN A will be transmitted from MIDI OUT/THRU. ([p.6-11](#))

- **MIDI sound sources connected to the SC-88 are not played from a computer or sequencer**

- Music data received at the SC-88 Computer connector is transmitted from the MIDI OUT/THRU connector, but you need to make the following settings. ([p.5-2](#), [p.6-11](#))
 - * Set the Computer switch to PC-1, PC-2 or Mac depending on your software
 - * Set MIDI OUT/THRU Select switch to OUT
- MIDI data received at MIDI IN A is transmitted from the MIDI OUT/THRU connector, but you need to make the following settings ([p.5-2](#), [p.6-11](#))
 - * Set the Computer switch to MIDI
 - * Set the MIDI OUT/THRU Select switch to THRU

■ If a message appears

If operation is incorrect or if the data cannot be processed correctly, an error message will appear in the display.

Consult the following list and take the appropriate action.

Battery Low

Cause : The memory backup battery inside the SC-88 has run down.
Action : Consult a nearby Roland Service Station.

Check Sum Error

Cause : The check sum of the received exclusive message is incorrect.
Action : Check the data which was transmitted to the SC-88, and transmit it once again. Also make sure that the MIDI cable is not broken.

MIDI Buff. Full

Cause : A large amount of MIDI data was received by the SC-88 in a time too short for correct processing to be done.
Action : Check whether a large amount of MIDI data is not being transmitted in a short time.

MIDI Off Line

Cause 1 : It is possible that the power has been turned off for the MIDI device connected to MIDI IN.
Action 1 : The problem is not with the SC-88. Check the power of the connected MIDI device.
Cause 2 : It is possible that a MIDI cable has been pulled out or broken.
Action 2 : Check the MIDI cables.

No INSTRUMENT

Cause : A sound (Instrument) which the SC-88 does not have has been selected.
Action : The SC-88 does not have this Instrument, so there will be no sound. Select a different Instrument.

No DRUM SET

Cause : A Drum Set which the SC-88 does not have has been selected.
Action : The previously selected Drum Set name will be displayed, and that set will sound.

■ Computer cable wiring diagrams

For Apple Macintosh (Sold separately: RSC-15APL)

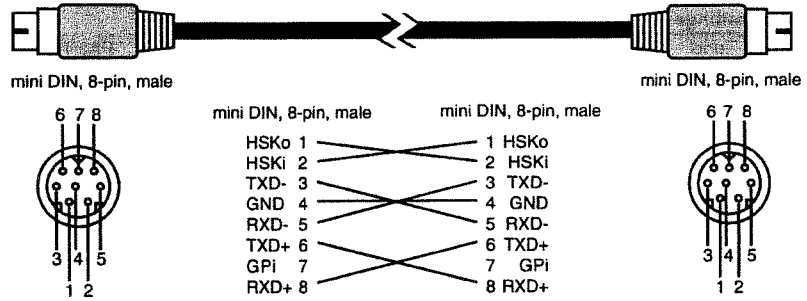

For IBM PC/AT (9-pin) (Sold separately: RSC-15AT)

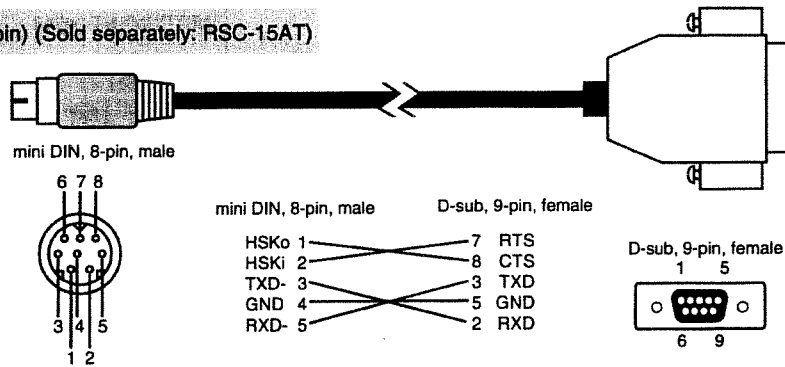

For IBM PC/AT (25-pin)

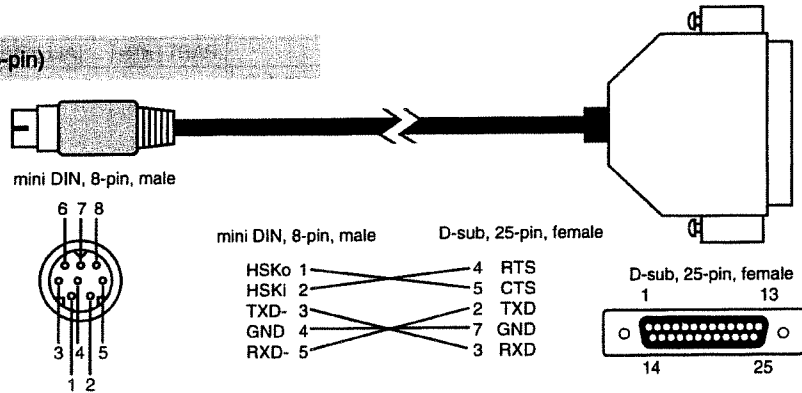

■ Parameter list and operations

Name of Function or Parameter	Range of values	Setting procedure	Refer to
Switching between the ALL display and PART display			
ALL/PART Select	ALL/PART	[ALL] (lit/dark)	
Overall Part settings			
Master Tune	415.3 - 440.0 - 466.2 Hz	[ALL] (lit) ... PART [◀]*[▶] ... [▲][▼] (select function) ... INSTRUMENT [◀][▶] (set value)	Page 1-8
Master Level	0 - 127	[ALL] (lit) ... LEVEL [◀][▶]	Page 2-21
Master Pan	L63 - 0 - R63	[ALL] (lit) ... PAN [◀][▶]	
Master Key Shift	-24 - 0 - +24	[ALL] (lit) ... KEY SHIFT [◀][▶]	
ALL Mute	Off , On	[ALL] (lit) ... [MUTE]	
ALL SC-55 Map	Off , On	[ALL] (lit) ... [SC-55 MAP]	
ALL EQ (All equalizer)	Off, On	[ALL] (lit) ... [EQ]	
Individual Part settings (make sure the ALL indicator is dark)			
Select an Instrument sound	1-128	PART [◀][▶] ... INSTRUMENT [◀][▶]	Page 1-4
Select a Variation sound	0-127	PART [◀][▶] ... VARIATION [◀][▶] or PART[◀][▶] ... INSTRUMENT [◀]*[▶] ... INSTRUMENT [◀][▶]	Page 1-5
Select a Drum Set	1-128	PART [◀][▶] ... INSTRUMENT [◀][▶]	Page 2-2
Level (Part Level)	0 - 100 - 127	PART [◀][▶] ... LEVEL [◀][▶]	Page 2-10
Pan (Part Pan)	Rnd, L63 - 0 - R63	PART [◀][▶] ... PAN [◀][▶]	
K.Shift (Part Key Shift)	-24 - 0 - +24	PART [◀][▶] ... K.SHIFT [◀][▶]	
PART MUTE	Off , On	PART [◀][▶] ... [MUTE]	
PART SC-55 Map	Off , On	PART [◀][▶] ... [SC-55 MAP]	
PART EQ (Part Equalizer)	Off, On	PART [◀][▶] ... [EQ]	
PART Monitor	Off , On	PART [◀][▶] ... [ALL]*[MUTE]	
Part Mode	Norm, Drum 1, 2		
M/P Mode (Mono/Poly mode)	Mono, Poly		
Fine Tune	-100 - 0.0 - +99.9		Page 2-11
Bend Range	0 - +2 - +24		
Mod. Depth (Modulation Depth)	0 - 10 - 127	[ALL] (dark) ... PART [◀]*[▶] ... [▲][▼] (select parameter)	
K.Range L (Keyboard Range Low)	C-1 - G9	INSTRUMENT [◀][▶] (set value)	
K.Range H (Keyboard Range High)	C-1 - G9		
Velo Depth (Velocity Sense Depth)	0 - 64 - 127		
Velo Offset (Velocity Sense Offset)	0 - 64 - 127		
CAf LFO Rate (Channel Aftertouch Rate)	-64 - 0 - +63		
CAf LFO Pitch (Channel Aftertouch Pitch)	0 - 127		
CAf LFO TVF (Channel Aftertouch TVF Depth)	0 - 127		
CAf LFO TVA (Channel Aftertouch TVA Depth)	0 - 127		Page 2-17
Vib.Rate (Vibrato Rate)	-64 - 0 - +63	PART [◀][▶] (select Part) ... [SELECT] (select parameter, indicator lights) ... DELAY [◀][▶] (set value)	
Vib.Depth (Vibrato Depth)	-64 - 0 - +63	PART [◀][▶] (select Part) ... [SELECT] (select parameter, indicator lights) ... INSTRUMENT [◀][▶] (set value)	
Vib.Delay (Vibrato Delay)	-64 - 0 - +63	PART [◀][▶] (select Part) ... [SELECT] (select parameter, indicator lights) ...	Page 2-17
		VARIATION [◀][▶] (set value)	Page 2-17

(Notes) ... : continue to the next step

Boldface indicates the factory setting value.

[A]*[B]: simultaneously press both buttons [A] and [B]

[A]+[B]: while holding button [A], press button [B]

Name of Function or Parameter	Range of values	Setting procedure	Refer to
Cutoff Freq. (Cutoff Frequency)	-64 - 0 - +63	PART [◀][▶] (select Part) ... [SELECT] (select parameter, indicator lights) ... INSTRUMENT [◀][▶] (set value)	Page 2-17
Resonance	-64 - 0 - +63	PART [◀][▶] (select Part) ... [SELECT] (select parameter, indicator lights) ... VARIATION [◀][▶] (set value)	Page 2-17
Attack Time	-64 - 0 - +63	PART [◀][▶] (select Part) ... [SELECT] (select parameter, indicator lights) ... DELAY [◀][▶] (set value)	Page 2-17
Decay Time	-64 - 0 - +63	PART [◀][▶] (select Part) ... [SELECT] (select parameter, indicator lights) ... INSTRUMENT [◀][▶] (set value)	Page 2-17
Release Time	-64 - 0 - +63	PART [◀][▶] (select Part) ... [SELECT] (select parameter, indicator lights) ... VARIATION [◀][▶] (set value)	Page 2-17
Effects			
Reverb Level (reverb for all Parts)	0 - 64 - 127	[ALL] (lit) ... REVERB [◀][▶]	Page 3-4
Chorus Level (chorus for all Parts)	0 - 64 - 127	[ALL] (lit) ... CHORUS [◀][▶]	
Delay Level (delay for all Parts)	0 - 64 - 127	[ALL] (lit) ... DELAY [◀][▶]	
Reverb Level (reverb level for each Part)	0 - 40 - 127	PART [◀][▶] ... REVERB [◀][▶]	Page 3-4
Chorus Level (reverb chorus for each Part)	0 - 127	PART [◀][▶] ... CHORUS [◀][▶]	
Delay Level (reverb delay for each Part)	0 - 127	PART [◀][▶] ... DELAY [◀][▶]	
Reverb Type	Room 1, 2, 3, Hall 1, 2, Plate, Delay Panning Delay		
Chorus Type	Chorus 1, 2, 3, 4, Feedback Chorus, Flanger, Short Delay, Short Delay (FB)		
Delay Type	Delay 1, 2, 3, 4, Pan Delay 1, 2, 3, 4, Delay To Reverb, Pan Repeat		
Reverb Character	0 - 4 - 7		Page 3-5
Reverb Pre-LPF (Reverb Pre Low Pass Filter)	0 - 7		
Reverb Level	0 - 64 - 127		
Reverb Time	0 - 64 - 127		
Reverb Delay Feedback	0 - 127	[ALL] (lit) ... PART [◀]*[▶] ...	
Reverb Pre Delay Time	0 - 127 (ms)	[▲][▼] (select parameter) ...	
Chorus Pre-LPF (Chorus Pre Low Pass Filter)	0 - 7	INSTRUMENT [◀][▶] (set value)	
Chorus Level	0 - 64 - 127		
Chorus Feedback	0 - 8 - 127		
Chorus Delay	0 - 80 - 127		
Chorus Rate	0 - 3 - 127		
Chorus Depth	0 - 19 - 127		
Chorus Send Level To Reverb	0 - 127		
Chorus Send Level To Delay	0 - 127		
Delay Pre-LPF (Delay Pre Low Pass Filter)	0 - 7		
Delay Time Center (Delay Time Center)	0.1 - 340 - 1000 (ms)		
Delay Time Ratio Left	4 -500 (%)		
Delay Time Ratio Right	4 -500 (%)		
Delay Level Center	0 - 25 - 127		
Delay Level Left	0 - 127		
Delay Level Right	0 - 127		
Delay Level	0 - 64 - 1270		
Delay Feedback	-64 - +16 - +63		
Delay Send To Reverb	0 - 127		

(Notes) ... : continue to the next step

Boldface indicates the factory setting value.

[A]*[B] : simultaneously press both buttons [A] and [B]

[A]+[B] : while holding button [A], press button [B]

Name of Function or Parameter	Range of values	Setting procedure	Refer to
Equalizer settings			
Low Freq (Equalizer Low Frequency)	200, 400	[ALL] (lit) ... SELECT ...	Page 3-3
High Freq (Equalizer High Frequency)	3K, 6K	DELAY [◀][▶] (select Gain/Frequency) ...	
Low Gain (Equalizer Low Gain)	-12 - 0 - +12	VARIATION [◀][▶](High Gain/Frequency)	
High Gain (Equalizer High Gain)	-12 - 0 - +12	INSTRUMENT [◀][▶](Low Gain/Frequency) ... [SELECT] (end procedure)	
Drum edit			
	PART [◀][▶] (select Drum Part) ... INSTRUMENT [◀][▶] (select Drum Set) ... [SELECT] * DELAY [◀] ... INSTRUMENT [◀][▶] (select drum sound to edit) ... PART [◀][▶] (select Part group and Part Mode)... LEVEL [◀][▶] (volume level) 0 - 127 PAN [◀][▶] (pan) Rnd, L63 - R63 REVERB [◀][▶] (reverb send level) 0 - 127 CHORUS [◀][▶] (chorus send level) 0 - 127 KEY SHIFT [◀][▶] (pitch coarse) 0 - 127 DELAY [◀][▶] (delay send level) 0 - 127 MIDI CH [◀][▶] (assign group) 0 - 127		Page 2-28
User edit			
User Instrument edit	INSTRUMENT [◀][▶] (select editing source Instrument) [ALL] dark ... [ON/OFF] lit... [SELECT] (select parameters) ... DELAY [◀][▶], INSTRUMENT [◀][▶], VARIATION [◀][▶] (set value) ... [ON/OFF] * [SELECT] ... INSTRUMENT [◀][▶] (set storing destination Instrument number) ... INSTRUMENT [◀] * [▶] ... INSTRUMENT [◀][▶] (set storing destination Variation number) ... [ALL] (execute), [MUTE] (cancel)		Page 4-2
User Drum edit	editing procedure is the same as Drum Edit		(Page 2-28)
Store a Drum Instrument	[SELECT] * DELAY [◀] ... [ON/OFF] * [SELECT] ... INSTRUMENT [◀][▶] (set storing destination Note number) ... INSTRUMENT [◀] * [▶] ... INSTRUMENT [◀][▶] (set storing destination User Drum Set number) ... [ALL] (execute), [MUTE] (cancel)		Page 4-6
Store an entire Drum Set	[SELECT] * DELAY [◀] ... VARIATION [◀]*[▶] ... INSTRUMENT [◀][▶] (set storing destination User Drum Set number) ... [ALL] (execute), [MUTE] (cancel)		Page 4-7
Name a Drum Set	[ALL] dark...PAN[▶] * CHORUS [▶] ... PART [◀][▶] (move cursor), INSTRUMENT [◀][▶] (select characters and symbols) [ALL] (A→a→A), [MUTE] (space), [▲] (0), [▼] (&→-&)		Page 4-8
MIDI-related			
MIDI CH (MIDI receive channel)	A01 - A16, A--, PART [◀][▶] ... MIDI CH [◀][▶] B01 - B16, B--		Page 2-7
IN B Sel. (IN B select)	Rear, Front		Page 2-24, 6-10
OUT/THRU (OUT/THRU select)	OUT, THRU	[▲]*[▼] ... [▲][▼] (select function) ...	
InMode (Input mode)	Standard, Xconnect, Merge→A, Merge→B, A only	INSTRUMENT [◀][▶] (set value)	
Rx Sys Mode (System Mode receive switch)	Off, On		Page 6-14
Rx GM On (GM System On receive switch)	Off, On	[ALL] (lit) ... PART [◀]*[▶] ... [▲][▼] (select function) ... INSTRUMENT [◀][▶] (set value)	
Rx GS Reset (GS Reset receive switch)	Off, On		Page 2-11
Rx Bank Sel (Bank Select receive switch)	Off, On	[ALL] (dark) ... PART [◀]*[▶] ... [▲][▼] (select function) ... INSTRUMENT [◀][▶] (set value)	
Rx NRPN (NRPN receive switch)	Off, On		Page 6-9
Device ID settings	1 - 17 - 32	[ALL] (lit) ... MIDI CH [◀][▶]	
Bulk dump		[ALL] (lit) ... INSTRUMENT [◀]*[▶] ... INSTRUMENT [◀][▶] (select the type of data) ... [ALL] (execute) [MUTE] (cancel)	Page 4-10

Name of Function or Parameter	Range of values	Setting procedure	Refer to
System functions			
Preview Note (Preview Note Name)	C-1 - A4 - G9	[▲]*[▼] ... [▲][▼] (select function) ... INSTRUMENT [◀][▶] (set value)	Page 2-24
Preview Velocity	0 - 100 - 127		
Display Type	Type 1 - 8		
Peak Hold	Off, Type 1 - 3		
LCD Contrast	1 - 8 16		
Backup (Backup Switch)	Off, On		
Other functions			
Mute Lock	Off, On	[ALL] (lit) ... PART [◀]*[▶] ... [▲][▼] (select function) ...	Page 6-14
EQ Lock	Off, On	INSTRUMENT [◀][▶] (set value)	
Set a display name	[ALL] (lit) ... PAN [▶] * CHORUS [▶] ... PART [◀][▶] (move cursor), INSTRUMENT [◀][▶] (select characters and symbols) [ALL] (A→a→A), [MUTE] (space), [▲] (0), [▼] (&→(→&)		Page 4-9
View settings for 32 Parts in the Part display	from the Part setting display ... INSTRUMENT [▶] * VARIATION [◀]		
Single Module mode	[SELECT] + K SHIFT [◀] ...	[ALL] (execute), [MUTE] (cancel)	Page 4-16
Double Module mode	[SELECT] + K SHIFT [▶] ...	[ALL] (execute), [MUTE] (cancel)	Page 4-16
Reset to factory settings	[SELECT] + INSTRUMENT [◀] * [▶] ...	[ALL] (execute), [MUTE] (cancel)	Page 4-18
Initialize for GM	[SELECT] + PART [▶] ...	[ALL] (execute), [MUTE] (cancel)	Page 4-18
Initialize for GS	[SELECT] + INSTRUMENT [▶] ...	[ALL] (execute), [MUTE] (cancel)	Page 4-18
Select CM-64 sounds	[SELECT] + INSTRUMENT [◀] ...	[ALL] (execute), [MUTE] (cancel)	Page 4-14
Draw pictures or characters on the screen (Frame Draw)	DELAY [▶] * INSTRUMENT [◀] ... [ALL] (dot on), [MUTE] (dot off), [▲][▼] (move cursor vertically), PART [◀][▶] (move cursor horizontally), INSTRUMENT [◀][▶] (set page), LEVEL [◀][▶] (move graphic vertically), PAN [◀][▶] (move graphic horizontally), INSTRUMENT [◀]*[▶] (transmit screen data to external device)		Page 4-12
Invert graphic:	(DELAY [▶] * INSTRUMENT [◀] ...) REVERB [◀][▶] ... INSTRUMENT [◀][▶] (select page) ... [ALL] (execute) [MUTE] (cancel)		
Copy graphic:	(DELAY [▶] * INSTRUMENT [◀] ...) K.SHIFT [◀][▶] ... INSTRUMENT [◀][▶] (set page) ... [ALL] (execute) [MUTE] (cancel)		
Delete graphic:	(DELAY [▶] * INSTRUMENT [◀] ...) MIDI CH [◀][▶] ... INSTRUMENT [◀][▶] (set page) ... [ALL] (execute) [MUTE] (cancel)		

(Notes) ... : continue to the next step

[A]*[B] : simultaneously press both buttons [A] and [B]

Boldface indicates the factory setting value.

[A]+[B] : while holding button [A], press button [B]

■ Instrument list SC-88 MAP (1)

SC-88 MAP

PC	CC00	Instrument	No. of voices	Remark
Piano				
001	000	Piano 1	1	
	008	Piano 1w	1	
	016	Piano 1d	1	
002	000	Piano 2	1	
	008	Piano 2w	1	
003	000	Piano 3	1	
	001	EG+Rhodes 1	2	
	002	EG+Rhodes 2	2	
	008	Piano 3w	1	
004	000	Honky-tonk	2	
	008	Old Upright	2	
005	000	E.Piano 1	2	
	008	St.Soft EP	2	
	016	FM+SA EP	2	
	024	60's E.Piano	1	
	025	Hard Rhodes	2	
	026	MellowRhodes	2	
006	000	E.Piano 2	2	
	008	Detuned EP 2	2	
	016	St.FM EP	2	
	024	Hard FM EP	2	
007	000	Harpsichord	1	
	008	Coupled Hps.	2	*
	016	Harpsi.w	1	
	024	Harpsi.o	2	
008	000	Clav.	1	
Chromatic percussion				
009	000	Celesta	1	*
010	000	Glockenspiel	1	
011	000	Music Box	1	
012	000	Vibraphone	1	
	001	Hard Vibe	2	
	008	Vib.w	1	*
013	000	Marimba	1	
	008	Marimba w	1	
	016	Barafon	1	
	017	Barafon 2	1	
	024	Log drum	1	
014	000	Xylophone	1	
015	000	Tubular-bell	1	*
	008	Church Bell	1	*
	009	Carillon	1	*
016	000	Santur	1	*
	001	Santur 2	2	
	008	Cimbalom	2	

PC	CC00	Instrument	No. of voices	Remark
Organ				
017	000	Organ 1	1	
	001	Organ 101	2	
	008	Detuned Or.1	2	
	009	Organ 109	2	
	016	60's Organ 1	1	
	017	60's Organ 2	1	
	018	60's Organ 3	1	
	024	Cheese Organ	1	
	032	Organ 4	1	
	033	Even Bar	2	
	040	Organ Bass	1	
018	000	Organ 2	1	
	001	Organ 201	2	
	008	Detuned Or.2	2	
	032	Organ 5	2	
019	000	Organ 3	2	*
	008	Rotary Org.	1	
	016	Rotary Org.S	1	
	024	Rotary Org.F	1	
020	000	Church Org.1	1	
	008	Church Org.2	2	
	016	Church Org.3	2	
	024	Organ Flute	1	
	032	Trem.Flute	2	
021	000	Reed Organ	1	*
022	000	Accordion Fr	1	
	008	Accordion It	2	
023	000	Harmonica	1	
	001	Harmonica 2	2	
024	000	Bandoneon	1	
Guitar				
025	000	Nylon-str.Gt	1	
	008	Ukulele	1	
	016	Nylon Gt.o	2	
	024	Velo Harmnix	1	
	032	Nylon Gt.2	1	
	040	Lequint Gt.	1	
026	000	Steel-str.Gt	1	
	008	12-str.Gt	2	
	009	Nylon+Steel	2	
	016	Mandolin	2	
	032	Steel Gt.2	1	
027	000	Jazz Gt.	1	*
	001	Mellow Gt.	2	
	008	Pedal Steel	1	

PC	CC00	Instrument	No. of voices	Remark
028	000	Clean Gt.	1	
	008	Chorus Gt.	2	
029	000	Muted Gt.	1	
	001	Muted Dis.Gt	1	
	008	Funk Pop	1	
	016	Funk Gt.2	1	
030	000	Overdrive Gt	1	
031	000	DistortionGt	1	
	001	Dist. Gt2	2	
	002	Dazed Guitar	2	
	008	Feedback Gt.	2	
	009	Feedback Gt2	2	
	016	Power Guitar	2	
	017	Power Gt.2	2	
	018	5th Dist.	2	
	024	Rock Rhythm	2	
	025	Rock Rhythm2	2	
032	000	Gt.Harmonics	1	*
	008	Gt. Feedback	1	*
	016	Ac.Gt.Harmnx	1	
Bass				
033	000	Acoustic Bs.	2	
034	000	Fingered Bs.	1	
	001	Fingered Bs2	2	
	002	Jazz Bass	1	
035	000	Picked Bass	1	
	008	Mute PickBs.	1	
036	000	Fretless Bs.	1	
	001	Fretless Bs2	2	
	002	Fretless Bs3	2	
	003	Fretless Bs4	2	
	004	Syn Fretless	2	
	005	Mr.Smooth	2	
037	000	Slap Bass 1	1	
	008	Reso Slap	1	
038	000	Slap Bass 2	2	
039	000	Synth Bass 1	2	
	001	SynthBass101	1	*
	008	Acid Bass	1	
	009	TB303 Bass	1	
	010	Tekno Bass	2	
	016	Reso SH Bass	1	

PC : program number (Instrument number)
 CC00 : value of controller number 0 (Bank number, Variation number)
 Instrument : sound name
 No. of voices : number of voices used by the Instrument
 Remark * : same sound as SC-55 map
 Remark ** : a percussive sound which cannot be played melodically. Use near C4 (note number 60).

SC-88 MAP (2)

PC	CC00	Instrument	No. of voices	Remark	PC	CC00	Instrument	No. of voices	Remark	PC	CC00	Instrument	No. of voices	Remark
040	000	Synth Bass 2	2		056	000	OrchestraHit	2		Pipe				
	001	SynthBass201	2			008	Impact Hit	2		073	000	Piccolo	1	
	002	Modular Bass	2			009	Philly Hit	2		074	000	Flute	1	
	003	Seq Bass	2			010	Double Hit	2		075	000	Recorder	1	*
	008	Beef FM Bass	2			016	Lo Fi Rave	2		076	000	Pan Flute	2	
	009	X Wire Bass	2		Brass						008	Kawala	2	
	016	Rubber Bass	2	*	057	000	Trumpet	1		077	000	Bottle Blow	2	
	017	SH101 Bass 1	1			001	Trumpet 2	1		078	000	Shakuhachi	2	*
	018	SH101 Bass 2	1			008	Flugel Horn	1		079	000	Whistle	1	*
	019	Smooth Bass	2			024	Bright Tp.	2		080	000	Ocarina	1	*
Strings / orchestra						025	Warm Tp.	2		Synth lead				
041	000	Violin	1		058	000	Trombone	1		081	000	Square Wave	2	*
	008	Slow Violin	1			001	Trombone 2	2	*		001	Square	1	*
042	000	Viola	1		059	000	Tuba	1			002	Hollow Mini	1	
043	000	Cello	1			001	Tuba 2	1			003	Mellow FM	2	
044	000	Contrabass	1		060	000	MutedTrumpet	1			004	CC Solo	2	
045	000	Tremolo Str	1		061	000	French Horns	1			005	Shmoog	2	
	008	Slow Tremolo	1			001	Fr.Horn 2	2	*		006	LM Square	2	
	009	Suspense Str	2			008	Fr.Horn Solo	1			008	Sine Wave	1	*
046	000	PizzicatoStr	1		062	000	Brass 1	1	*	082	000	Saw Wave	2	*
047	000	Harp	1			008	Brass 2	2			001	Saw	1	*
048	000	Timpani	1			016	Brass Fall	1			002	Pulse Saw	2	
Ensemble					063	000	Synth Brass1	2			003	Feline GR	2	
049	000	Strings	1			001	Poly Brass	2			004	Big Lead	2	
	001	Strings 2	1			008	Synth Brass3	2	*		005	Velo Lead	2	
	008	Orchestra	2			009	Quack Brass	2			006	GR-300	2	
	009	Orchestra 2	2			016	Octave Brass	2			007	LA Saw	1	
	010	Tremolo Orch	2		064	000	Synth Brass2	2	*		008	Doctor Solo	2	*
	011	Choir Str.	2			001	Soft Brass	2			016	Waspy Synth	2	
	016	St.Strings	2			008	Synth Brass4	1	*	083	000	Syn.Calliope	2	*
	024	Velo Strings	2			016	Velo Brass 1	2			001	Vent Synth	2	
050	000	Slow Strings	1			017	Velo Brass 2	2			002	Pure PanLead	2	
	001	SlowStrings2	1		Reed					084	000	Chiffer Lead	2	*
	008	Legato Str.	2		065	000	Soprano Sax	1		085	000	Charang	2	*
	009	Warm Strings	2		066	000	Alto Sax	1			008	Dist.Lead	2	
	010	St.Slow Str.	2			008	Hyper Alto	1		086	000	Solo Vox	2	*
051	000	Syn.Strings1	2		067	000	Tenor Sax	2		087	000	5th Saw Wave	2	*
	001	OB Strings	2			008	BreathyTenor	1			001	Big Fives	2	
	008	Syn.Strings3	2	*	068	000	Baritone Sax	1		088	000	Bass & Lead	2	*
052	000	Syn.Strings2	2	*		069	Oboe	1			001	Big & Raw	2	
053	000	Choir Aahs	1		070	000	English Horn	1			002	Fat & Perky	2	
	008	St.Choir	2		071	000	Bassoon	1		Synth pad, etc.				
	009	Mello Choir	2		072	000	Clarinet	1		089	000	Fantasia	2	*
	032	Choir Aahs 2	1	*		008	Bs Clarinet	1			001	Fantasia 2	2	
054	000	Voice Oohs	1	*						090	000	Warm Pad	1	*
055	000	SynVox	1	*							001	Thick Pad	2	
	008	Syn.Voice	2								002	Horn Pad	2	
											003	Rotary Strng	2	
											004	Soft Pad	2	

SC-88 MAP (3)

PC	CC00	Instrument	No. of voices	Remark	PC	CC00	Instrument	No. of voices	Remark	PC	CC00	Instrument	No. of voices	Remark
091	000	Polysynth	2	*	103	000	Echo Drops	1	*	118	000	Melo. Tom 1	1	* **
	001	80's PolySyn	2			001	Echo Bell	2	*		001	Real Tom	2	**
092	000	Space Voice	1	*		002	Echo Pan	2	*		008	Melo. Tom 2	1	* **
	001	Heaven II	2			003	Echo Pan 2	2			009	Rock Tom	2	**
093	000	Bowed Glass	2	*		004	Big Panner	2		119	000	Synth Drum	1	* **
094	000	Metal Pad	2	*		005	Reso Panner	2			008	808 Tom	2	**
	001	Tine Pad	2			006	Water Piano	2			009	Elec Perc	1	* **
	002	Panner Pad	2		104	000	Star Theme	2	*	120	000	Reverse Cym.	1	* **
095	000	Halo Pad	2	*		001	Star Theme 2	2			001	Reverse Cym2	1	**
096	000	Sweep Pad	1	*	Ethnic, etc.						008	Rev.Snare 1	1	**
	001	Polar Pad	1		105	000	Sitar	1	*		009	Rev.Snare 2	1	**
	008	Converge	1			001	Sitar 2	2	*		016	Rev.Kick 1	1	**
	009	Shwimmer	2			002	Detune Sitar	2			017	Rev.ConBD	1	**
	010	Celestial Pd	2			008	Tambra	1			024	Rev.Tom 1	1	**
Synth SFX						016	Tamboura	2			025	Rev.Tom 2	1	**
097	000	Ice Rain	2	*	106	000	Banjo	1		SFX				
	001	Harmo Rain	2			001	Muted Banjo	1		121	000	Gt.FretNoise	1	*
	002	African wood	2			008	Rabab	2			001	Gt.Cut Noise	1	* **
	008	Clavi Pad	2			016	Gopichant	2			002	String Slap	1	* **
098	000	Soundtrack	2	*		024	Oud	2			003	Gt.CutNoise2	1	**
	001	Ancestral	2		107	000	Shamisen	1	*		004	Dist.CutNoiz	1	**
	002	Prologue	2			001	Tsugaru	2			005	Bass Slide	1	**
	008	Rave	2		108	000	Koto	1	*		006	Pick Scrape	1	**
099	000	Crystal	2	*		008	Taisho Koto	1		122	000	Breath Noise	1	*
	001	Syn Mallet	1	*		016	Kanoon	2			001	Fl.Key Click	1	* **
	002	Soft Crystal	2		109	000	Kalimba	1		123	000	Seashore	1	* **
	003	Round Glock	2		110	000	Bagpipe	1			001	Rain	1	* **
	004	Loud Glock	2		111	000	Fiddle	1	*		002	Thunder	1	* **
	005	GlockenChime	2		112	000	Shanai	1	*		003	Wind	1	* **
	006	Clear Bells	2			001	Shanai 2	1			004	Stream	2	* **
	007	ChristmasBel	2			008	Pungi	1			005	Bubble	2	* **
	008	Vibra Bells	2			016	Hichiriki	2		124	000	Bird	2	* **
	009	Digi Bells	2		Percussive						001	Dog	1	* **
	016	Choral Bells	2		113	000	Tinkle Bell	1	*		002	Horse-Gallop	1	* **
	017	Air Bells	2			008	Bonang	1			003	Bird 2	1	* **
	018	Bell Harp	2			009	Gender	1			004	Kitty	1	**
	019	Gamelimba	2			010	Gamelan Gong	1			005	Growl	1	**
100	000	Atmosphere	2	*		011	St.Gamelan	2		125	000	Telephone 1	1	* **
	001	Warm Atmos	2			016	RAMA Cymbal	1			001	Telephone 2	1	* **
	002	Nylon Harp	2		114	000	Agogo	1			002	DoorCreaking	1	* **
	003	Harpvox	2			008	Atarigane	1			003	Door	1	* **
	004	HollowReleas	2		115	000	Steel Drums	1	*		004	Scratch	1	* **
	005	Nylon+Rhodes	2		116	000	Woodblock	1	* **		005	Wind Chimes	2	* **
	006	Ambient Pad	2			008	Castanets	1	* **		007	Scratch 2	1	**
101	000	Brightness	2	*	117	000	Taiko	1	* **					
102	000	Goblin	2	*		008	Concert BD	1	* **					
	001	Goblinson	2											
	002	50's Sci-Fi	2											

PC : program number (Instrument number)
 CC00 : value of controller number 0 (Bank number, Variation number)
 Instrument : sound name
 No. of voices : number of voices used by the Instrument
 Remark * : same sound as SC-55 map
 Remark ** : a percussive sound which cannot be played melodically. Use near C4 (note number 60).

SC-55 MAP (1)

PC	CC00	Instrument	No. of voices	Remark	SC-55 MAP					PC	CC00	Instrument	No. of voices	Remark
126	000	Helicopter	1	* **	PC	CC00	Instrument	No. of voices	Remark	021	000	Reed Organ	1	
	001	Car-Engine	1	* **	Piano					022	000	Accordion F	2	
	002	Car-Stop	1	* **	001	000	Piano 1	1		008	000	Accordion I	2	
	003	Car-Pass	1	* **	008	000	Piano 1w	1		023	000	Harmonica	1	
	004	Car-Crash	2	* **	016	000	Piano 1d	1		024	000	Bandoneon	2	
	005	Siren	1	* **	002	000	Piano 2	1		Guitar				
	006	Train	1	* **	008	000	Piano 2w	1		025	000	Nylon Gt.	1	
	007	Jetplane	2	* **	003	000	Piano 3	1		008	000	Ukulele	1	
	008	Starship	2	* **	008	000	Piano 3w	1		016	000	Nylon Gt.o	2	
	009	Burst Noise	2	* **	004	000	Honky-tonk	2		032	000	Nylon Gt.2	1	
127	000	Applause	2	* **	008	000	HonkyTonk w	2		026	000	Steel Gt.	1	
	001	Laughing	1	* **	005	000	E.Piano 1	1		008	000	12-str.Gt	2	
	002	Screaming	1	* **	008	000	Detuned EP1	2		016	000	Mandolin	1	
	003	Punch	1	* **	016	000	E.Piano 1v	2		027	000	Jazz Gt.	1	
	004	Heart Beat	1	*	024	000	60s E.Piano	1		008	000	Hawaiian Gt	1	
	005	Footsteps	1	* **	006	000	E.Piano 2	1		028	000	Clean Gt.	1	
	006	Applause 2	2	* **	008	000	Detuned EP2	2		008	000	Chorus Gt.	2	
128	000	Gun Shot	1	* **	016	000	E.Piano 2v	2		029	000	Muted Gt.	1	
	001	Machine Gun	1	* **	007	000	Harpsichord	1		008	000	Funk Gt.	1	
	002	Lasergun	1	* **	008	000	Coupled Hps	2		016	000	Funk Gt.2	1	
	003	Explosion	2	* **	016	000	Harpsi.w	1		030	000	OverdriveGt	1	
					024	000	Harpsi.o	2		031	000	Dist.Gt.	1	
					008	000	Clav.	1		008	000	Feedback Gt	2	
					Chromatic percussion					032	000	Gt.Harmonix	1	
					009	000	Celesta	1		008	000	Gt.Feedback	1	
					010	000	Glockenspl	1		Bass				
					011	000	Music Box	1		033	000	Acoustic Bs	1	
					012	000	Vibraphone	1		034	000	Fingered Bs	1	
					008	000	Vib.w	1		035	000	Picked Bass	1	
					013	000	Marimba	1		036	000	Fretless Bs	1	
					008	000	Marimba w	1		037	000	Slap Bass 1	1	
					014	000	Xylophone	1		038	000	Slap Bass 2	1	
					015	000	Tubularbell	1		039	000	Syn.Bass 1	1	
					008	000	Church Bell	1		001	000	Syn.Bass101	1	
					009	000	Carillon	1		008	000	Syn.Bass 3	1	
					016	000	Santur	1		040	000	Syn.Bass 2	2	
					Organ					008	000	Syn.Bass 4	2	
					017	000	Organ 1	1		016	000	Rubber Bass	2	
					008	000	Detuned Or1	2		Strings / orchestra				
					016	000	60's Organ1	1		041	000	Violin	1	
					032	000	Organ 4	2		008	000	Slow Violin	1	
					018	000	Organ 2	1		042	000	Viola	1	
					008	000	Detuned Or2	2		043	000	Cello	1	
					032	000	Organ 5	2		044	000	Contrabass	1	
					019	000	Organ 3	2		045	000	Tremolo Str	1	
					020	000	Church Org1	1		046	000	Pizzicato	1	
					008	000	Church Org2	2		047	000	Harp	1	
					016	000	Church Org3	2		048	000	Timpani	1	

SC-55 MAP (2)

PC	CC00	Instrument	No. of voices	Remark	PC	CC00	Instrument	No. of voices	Remark	PC	CC00	Instrument	No. of voices	Remark
Ensemble					Synth lead					Percussive				
049	000	Strings	1		081	000	Square Wave	2		113	000	Tinkle Bell	1	
	008	Orchestra	2			001	Square	1		114	000	Agogo	1	
050	000	SlowStrings	1			008	Sine Wave	1		115	000	Steel Drums	1	
051	000	SynStrings1	1		082	000	Saw Wave	2		116	000	Woodblock	1	**
	008	SynStrings3	2			001	Saw	1			008	Castanets	1	**
052	000	SynStrings2	2			008	Doctor Solo	2		117	000	Taiko	1	**
053	000	Choir Aah	1		083	000	SynCalliope	2			008	Concert BD	1	**
	032	Choir Aahs2	1		084	000	ChifferLead	2		118	000	Melo. Tom 1	1	**
054	000	Voice Oohs	1		085	000	Charang	2			008	Melo. Tom 2	1	**
055	000	SynVox	1		086	000	Solo Vox	2		119	000	Synth Drum	1	**
056	000	Orchest.Hit	2		087	000	5th Saw	2			008	808 Tom	1	**
Brass						088	Bass & Lead	2			009	Elec Perc	1	**
057	000	Trumpet	1		Synth pad, etc.					120	000	Reverse Cym	1	**
058	000	Trombone	1		089	000	Fantasia	2		SFX				
	001	Trombone 2	2		090	000	Warm Pad	1		121	000	Gt.FretNoiz	1	
059	000	Tuba	1		091	000	Polysynth	2			001	Gt.CutNoise	1	**
060	000	MuteTrumpet	1		092	000	Space Voice	1			002	String Slap	1	**
061	000	French Horn	2		093	000	Bowed Glass	2		122	000	BreathNoise	1	
	001	Fr.Horn 2	2		094	000	Metal Pad	2			001	Fl.KeyClick	1	**
062	000	Brass 1	1		095	000	Halo Pad	2		123	000	Seashore	1	**
	008	Brass 2	2		096	000	Sweep Pad	1			001	Rain	1	**
063	000	Syn.Brass 1	2		Synth SFX						002	Thunder	1	**
	008	Syn.Brass 3	2		097	000	Ice Rain	2			003	Wind	1	**
	016	Analog Brs1	2		098	000	Soundtrack	2			004	Stream	2	**
064	000	Syn.Brass 2	2		099	000	Crystal	2			005	Bubble	2	**
	008	Syn.Brass 4	1			001	Syn Mallet	1		124	000	Bird	2	**
	016	Analog Brs2	2		100	000	Atmosphere	2			001	Dog	1	**
Reed					101	000	Brightness	2			002	HorseGallop	1	**
065	000	Soprano Sax	1		102	000	Goblin	2			003	Bird 2	1	**
066	000	Alto Sax	1		103	000	Echo Drops	1		125	000	Telephone 1	1	**
067	000	Tenor Sax	1			001	Echo Bell	2			001	Telephone 2	1	**
068	000	BaritoneSax	1			002	Echo Pan	2			002	Creaking	1	**
069	000	Oboe	1		104	000	Star Theme	2			003	Door	1	**
070	000	EnglishHorn	1		Ethnic, etc.						004	Scratch	1	**
071	000	Bassoon	1		105	000	Sitar	1			005	Wind Chimes	2	**
072	000	Clarinet	1			001	Sitar 2	2		126	000	Helicopter	1	**
Pipe					106	000	Banjo	1			001	Car-Engine	1	**
073	000	Piccolo	1		107	000	Shamisen	1			002	Car-Stop	1	**
074	000	Flute	1		108	000	Koto	1			003	Car-Pass	1	**
075	000	Recorder	1			008	Taisho Koto	2			004	Car-Crash	2	**
076	000	Pan Flute	1		109	000	Kalimba	1			005	Siren	1	**
077	000	Bottle Blow	2		110	000	Bagpipe	1			006	Train	1	**
078	000	Shakuhachi	2		111	000	Fiddle	1			007	Jetplane	2	**
079	000	Whistle	1		112	000	Shanai	1			008	Starship	2	**
080	000	Ocarina	1								009	Burst Noise	2	**
										127	000	Applause	2	**
											001	Laughing	1	**
											002	Screaming	1	**
											003	Punch	1	**
											004	Heart Beat	1	**
											005	Footsteps	1	**
										128	000	Gun Shot	1	**
											001	Machine Gun	1	**
											002	Lasergun	1	**
											003	Explosion	2	**

PC : program number (Instrument number)
 CC00 : value of controller number 0 (Bank number, Variation number)
 Instrument : sound name
 No. of voices : number of voices used by the Instrument
 Remark * : same sound as SC-55 map
 Remark ** : a percussive sound which cannot be played melodically. Use near C4 (note number 60).

SC-55 MAP (3)

CM-64				CM-64				CM-64			
PC	CC00	Instrument	No. of voices	PC	CC00	Instrument	No. of voices	PC	CC00	Instrument	No. of voices
001	126	Piano 2	1	001	127	Acou Piano1	1	065	127	Acou Bass 1	1
002	126	Piano 2	1	002	127	Acou Piano2	1	066	127	Acou Bass 2	1
003	126	Piano 2	1	003	127	Acou Piano3	1	067	127	Elec Bass 1	1
004	126	Honky-tonk	2	004	127	Elec Piano1	1	068	127	Elec Bass 2	1
005	126	Piano 1	1	005	127	Elec Piano2	1	069	127	Slap Bass 1	1
006	126	Piano 2	1	006	127	Elec Piano3	1	070	127	Slap Bass 2	1
007	126	Piano 2	1	007	127	Elec Piano4	1	071	127	Fretless 1	1
008	126	E.Piano 1	1	008	127	Honkytonk	2	072	127	Fretless 2	1
009	126	Detuned EP1	2	009	127	Elec Org 1	1	073	127	Flute 1	1
010	126	E.Piano 2	1	010	127	Elec Org 2	2	074	127	Flute 2	1
011	126	Steel Gt.	1	011	127	Elec Org 3	1	075	127	Piccolo 1	1
012	126	Steel Gt.	1	012	127	Elec Org 4	1	076	127	Piccolo 2	2
013	126	12-str.Gt	2	013	127	Pipe Org 1	2	077	127	Recorder	2
014	126	Funk Gt.	1	014	127	Pipe Org 2	2	078	127	Pan Pipes	1
015	126	Muted Gt.	1	015	127	Pipe Org 3	2	079	127	Sax 1	1
016	126	Slap Bass 1	1	016	127	Accordion	2	080	127	Sax 2	1
017	126	Slap Bass 1	1	017	127	Harpsi 1	1	081	127	Sax 3	1
018	126	Slap Bass 1	1	018	127	Harpsi 2	2	082	127	Sax 4	1
019	126	Slap Bass 1	1	019	127	Harpsi 3	1	083	127	Clarinet 1	1
020	126	Slap Bass 2	1	020	127	Clavi 1	1	084	127	Clarinet 2	1
021	126	Slap Bass 2	1	021	127	Clavi 2	1	085	127	Oboe	1
022	126	Slap Bass 2	1	022	127	Clavi 3	1	086	127	Engl Horn	1
023	126	Slap Bass 2	1	023	127	Celesta 1	1	087	127	Bassoon	1
024	126	Fingered Bs	1	024	127	Celesta 2	1	088	127	Harmonica	1
025	126	Fingered Bs	1	025	127	Syn Brass 1	2	089	127	Trumpet 1	1
026	126	Picked Bass	1	026	127	Syn Brass 2	2	090	127	Trumpet 2	1
027	126	Picked Bass	1	027	127	Syn Brass 3	2	091	127	Trombone 1	2
028	126	Fretless Bs	1	028	127	Syn Brass 4	2	092	127	Trombone 2	2
029	126	Acoustic Bs	1	029	127	Syn Bass 1	1	093	127	Fr Horn 1	2
030	126	Choir Aahs	1	030	127	Syn Bass 2	2	094	127	Fr Horn 2	2
031	126	Choir Aahs	1	031	127	Syn Bass 3	2	095	127	Tuba	1
032	126	Choir Aahs	1	032	127	Syn Bass 4	1	096	127	Brs Sect 1	1
033	126	Choir Aahs	1	033	127	Fantasy	2	097	127	Brs Sect 2	2
034	126	SlowStrings	1	034	127	Harmo Pan	2	098	127	Vibe 1	1
035	126	Strings	1	035	127	Chorale	1	099	127	Vibe 2	1
036	126	SynStrings3	2	036	127	Glasses	2	100	127	Syn Mallet	1
037	126	SynStrings3	2	037	127	Soundtrack	2	101	127	Windbell	2
038	126	Organ 1	1	038	127	Atmosphere	2	102	127	Glock	1
039	126	Organ 1	1	039	127	Warm Bell	2	103	127	Tube Bell	1
040	126	Organ 1	1	040	127	Funny Vox	1	104	127	Xylophone	1
041	126	Organ 2	1	041	127	Echo Bell	2	105	127	Marimba	1
042	126	Organ 1	1	042	127	Ice Rain	2	106	127	Koto	1
043	126	Organ 1	1	043	127	Oboe 2001	2	107	127	Sho	2
044	126	Organ 2	1	044	127	Echo Pan	2	108	127	Shakuhachi	2
045	126	Organ 2	1	045	127	Doctor Solo	2	109	127	Whistle 1	2
046	126	Organ 2	1	046	127	School Daze	1	110	127	Whistle 2	1
047	126	Trumpet	1	047	127	Bellsinger	1	111	127	Bottleblow	2
048	126	Trumpet	1	048	127	Square Wave	2	112	127	Breathpipe	1
049	126	Trombone	1	049	127	Str Sect 1	1	113	127	Timpani	1
050	126	Trombone	1	050	127	Str Sect 2	1	114	127	Melodic Tom	1
051	126	Trombone	1	051	127	Str Sect 3	1	115	127	Deep Snare	1 **
052	126	Trombone	1	052	127	Pizzicato	1	116	127	Elec Perc 1	1 **
053	126	Trombone	1	053	127	Violin 1	1	117	127	Elec Perc 2	1 **
054	126	Trombone	1	054	127	Violin 2	1	118	127	Taiko	1 **
055	126	Alto Sax	1	055	127	Cello 1	1	119	127	Taiko Rim	1
056	126	Tenor Sax	1	056	127	Cello 2	1	120	127	Cymbal	1
057	126	BaritoneSax	1	057	127	Contrabass	1	121	127	Castanets	1 **
058	126	Alto Sax	1	058	127	Harp 1	1	122	127	Triangle	1 **
059	126	Brass 1	1	059	127	Harp 2	1	123	127	Orche Hit	1
060	126	Brass 1	1	060	127	Guitar 1	1	124	127	Telephone	1 **
061	126	Brass 2	2	061	127	Guitar 2	1	125	127	Bird Tweet	1 **
062	126	Brass 2	2	062	127	Elec Gtr 1	1	126	127	OneNote Jam	1 **
063	126	Brass 1	1	063	127	Elec Gtr 2	1	127	127	Water Bell	2
064	126	Orchest.Hit	2	064	127	Sitar	2	128	127	Jungle Tune	2

Drum set list

SC-88 Drum set (1)

	PC 1 STANDARD Set1	PC 2 STANDARD Set2	PC 9 ROOM Set	PC 17 POWER Set	PC 25 ELECTRONIC Set
25	Snare Roll	←	←	←	←
26	Finger Snap	←	←	←	←
27	High Q	←	←	←	←
28	Slap	←	←	←	←
29	Scratch Push [EXC7]	←	←	←	Scratch Push2 [EXC7]
30	Scratch Pull [EXC7]	←	←	←	Scratch Pull2 [EXC7]
31	Sticks	←	←	←	←
32	Square Click	←	←	←	←
33	Metronome Click	←	←	←	←
34	Metronome Bell	←	←	←	←
35	Standard 1 Kick 2	Standard 2 Kick 2	Room Kick 2	Power Kick 2	Electric Kick 2
C2 36	Standard 1 Kick 1	Standard 2 Kick 1	Room Kick 1	Power Kick 1	Electric Kick 1
37	Side Stick	←	←	←	←
38	Standard 1 Snare 1	Standard 2 Snare 1	Room Snare 1	Power Snare 1	Electric Snare 1
39	Hand Clap	←	←	←	←
40	Standard 1 Snare 2	Standard 2 Snare 2	Room Snare 2	PowerSnare 2	Electric Snare 2
41	Low Tom2 *	←	Room Low Tom2 *	Power Low Tom2 *	Electric Low Tom2 *
42	Closed Hi-hat1 [EXC1]	Closed Hi-hat2 [EXC1]	Closed Hi-hat3 [EXC1]	Closed Hi-hat3 [EXC1]	Closed Hi-hat2 [EXC1]
43	Low Tom1 *	←	Room Low Tom1 *	Power Low Tom1 *	Electric Low Tom1 *
44	Pedal Hi-hat [EXC1]	←	←	←	←
45	Mid Tom2 *	←	Room Mid Tom2 *	Power Mid Tom2 *	Electric Mid Tom2 *
46	Open Hi-hat1 [EXC1]	Open Hi-hat2 [EXC1]	Open Hi-hat3 [EXC1]	Open Hi-hat3 [EXC1]	Open Hi-hat2 [EXC1]
47	Mid Tom1 *	←	Room Mid Tom1 *	Power Mid Tom1 *	Electric Mid Tom1 *
C3 48	High Tom2 *	←	Room Hi Tom2 *	Power Hi Tom2 *	Electric Hi Tom2 *
49	Crash Cymbal1	←	←	←	←
50	High Tom1 *	←	Room Hi Tom1 *	Power Hi Tom1 *	Electric Hi Tom1 *
51	Ride Cymbal1	←	←	←	←
52	Chinese Cymbal	←	←	←	Reverse Cymbal
53	Ride Bell	←	←	←	←
54	Tambourine	←	←	←	←
55	Splash Cymbal	←	←	←	←
56	Cowbell	←	←	←	←
57	Crash Cymbal2	←	←	←	←
58	Vibra-slap	←	←	←	←
59	Ride Cymbal2	←	←	←	←
C4 60	High Bongo	←	←	←	←
61	Low Bongo	←	←	←	←
62	Mute High Conga	←	←	←	←
63	Open High Conga	←	←	←	←
64	Low Conga	←	←	←	←
65	High Timbale	←	←	←	←
66	Low Timbale	←	←	←	←
67	High Agogo	←	←	←	←
68	Low Agogo	←	←	←	←
69	Cabasa	←	←	←	←
70	Maracas	←	←	←	←
71	Short Hi Whistle [EXC2]	←	←	←	←
C5 72	Long Low Whistle [EXC2]	←	←	←	←
73	Short Guiro [EXC3]	←	←	←	←
74	Long Guiro [EXC3]	←	←	←	←
75	Claves	←	←	←	←
76	High Wood Block	←	←	←	←
77	Low Wood Block	←	←	←	←
78	Mute Cuica [EXC4]	←	←	←	←
79	Open Cuica [EXC4]	←	←	←	←
80	Mute Triangle [EXC5]	←	←	←	←
81	Open Triangle [EXC5]	←	←	←	←
82	Shaker	←	←	←	←
83	Jingle Bell	←	←	←	←
C6 84	Bell Tree	Bar Chimes	←	←	←
85	Castanets	←	←	←	←
86	Mute Surdo [EXC6]	←	←	←	←
87	Open Surdo [EXC6]	←	←	←	←
88	----	----	----	----	----
89	----	----	----	----	----
90	----	----	----	----	----
91	----	----	----	----	----
92	----	----	----	----	----
93	----	----	----	----	----
94	----	----	----	----	----
95	----	----	----	----	----
C7 96	----	----	----	----	----
97	----	----	----	----	----
98	----	----	----	----	----
99	----	----	----	----	----

Note Number ↑

PC : Program Number (Drum Set Number)
 ---- : No sound
 * : Tones which are created using two voices

← : Same as the percussion sound of "STANDARD" (PC1).
 [EXC]: Percussion sound of the same number will not be heard at the same time.

SC-88 Drum set (2)

	PC 26 TR-808/909 Set	PC 27 DANCE Set	PC 33 JAZZ Set	PC 41 BRUSH Set	PC 49 ORCHESTRA Set
25	←	←	←	←	←
26	←	←	←	←	←
27	←	←	←	←	←
28	←	←	←	←	Closed Hi-hat2 [EXC1]
29	Scratch Push2 [EXC7]	Scratch Push2 [EXC7]	←	←	Pedal Hi-hat [EXC1]
30	Scratch Pull2 [EXC7]	Scratch Pull2 [EXC7]	←	←	Open Hi-hat2 [EXC1]
31	←	←	←	←	Ride Cymbal1
32	←	←	←	←	←
33	←	←	←	←	←
34	←	←	←	←	←
35	909 Bass Drum	Dance Kick	Jazz Kick 2	Jazz Kick 2	Jazz Kick 1
36	808 Bass Drum	Electric Kick 2	Jazz Kick 1	Jazz Kick 1	Concert BD1
37	808 Rim Shot	←	←	←	←
38	808 Snare 1	Dance Snare 1	Jazz Snare 1	Brush Tap1	Concert SD
39	←	←	Hand Clap2	Brush Slap1	Castanets
40	909 Snare 1	Dance Snare 2	Jazz Snare 2	Brush Swirl1	Concert SD
41	808 Low Tom2 *	Electric Low Tom2 *	←	Brush Low Tom2 *	Timpani F
42	808 CHH [EXC1]	CR-78 CHH [EXC1]	Closed Hi-hat2 [EXC1]	Brush Closed Hi-hat [EXC1]	Timpani F#
43	808 Low Tom1 *	Electric Low Tom1 *	←	Brush Low Tom1 *	Timpani G
44	808 CHH [EXC1]	808 CHH [EXC1]	←	←	Timpani G#
45	808 Mid Tom2 *	Electric Mid Tom2 *	←	Brush Mid Tom2 *	Timpani A
46	808 OHH [EXC1]	CR-78 OHH [EXC1]	Open Hi-hat2 [EXC1]	Brush Open Hi-hat [EXC1]	Timpani A#
47	808 Mid Tom1 *	Electric Mid Tom1 *	←	Brush Mid Tom1 *	Timpani B
48	808 Hi Tom2 *	Electric High Tom2 *	←	Brush Hi Tom2 *	Timpani c
49	808 Cymbal	←	←	Brush Crash Cymbal	Timpani c#
50	808 Hi Tom1	Electric High Tom1 *	←	Brush Hi Tom1 *	Timpani d
51	←	←	←	Brush Ride Cymbal	Timpani d#
52	←	Reverse Cymbal	←	←	Timpani e
53	←	←	←	Brush Ride Bell	Timpani f
54	←	←	←	←	←
55	←	←	←	←	←
56	808 Cowbell	←	←	←	←
57	←	←	←	←	Concert Cymbal2
58	←	←	←	←	←
59	←	←	←	←	Concert Cymbal1
60	←	←	←	←	←
61	←	←	←	←	←
62	808 High Conga	←	←	←	←
63	808 Mid Conga	←	←	←	←
64	808 Low Conga	←	←	←	←
65	←	←	←	←	←
66	←	←	←	←	←
67	←	←	←	←	←
68	←	←	←	←	←
69	←	←	←	←	←
70	808 Maracas	←	←	←	←
71	←	←	←	←	←
72	←	←	←	←	←
73	←	←	←	←	←
74	←	←	←	←	←
75	808 Claves	←	←	←	←
76	←	←	←	←	←
77	←	←	←	←	←
78	←	High Hoo [EXC4]	←	←	←
79	←	Low Hoo [EXC4]	←	←	←
80	←	Electric Mute Triangle [EXC5]	←	←	←
81	←	Electric Open Triangle [EXC5]	←	←	←
82	←	←	←	←	←
83	←	←	←	←	←
84	←	←	←	←	←
85	←	←	←	←	←
86	←	←	←	←	←
87	←	←	←	←	←
88	----	----	----	----	Applause *
89	----	----	----	----	----
90	----	----	----	----	----
91	----	----	----	----	----
92	----	----	----	----	----
93	----	----	----	----	----
94	----	----	----	----	----
95	----	----	----	----	----
96	----	----	----	----	----
97	----	----	----	----	----
98	----	----	----	----	----
99	----	----	----	----	----

Note Number

PC : Program Number (Drum Set Number)
 ---- : No sound
 * : Tones which are created using two voices

← : Same as the percussion sound of "STANDARD" (PC1).
 [EXC]: Percussion sound of the same number will not be heard at the same time.

SC-88 Drum set (2)

	PC 50	PC 51	PC 57	PC 58
	ETHNIC Set	KICK&SNARE Set	SFX Set	RHYTHM FX Set
25	Finger Snap	----	----	----
26	Tambourine	----	----	----
27	Castanets	----	----	----
28	Crash Cymbal1	----	----	----
	Snare Roll	----	----	----
29	Concert Snare Drum	----	----	----
31	Concert Cymbal	----	Scratch Push2 [EXC1]	----
32	Concert BD1	----	Scratch Pull2 [EXC1]	----
33	Jingle Bell	----	Cutting Noise 2 Up	----
34	Bell Tree	----	Cutting Noise 2 Down	----
35	Bar Chimes	----	Distortion Guitar Cutting Noise Up	----
C2 36	Wadaiko *	----	Distortion Guitar Cutting Noise Down	Reverse Kick 1
37	Wadaiko Rim *	----	Bass Slide	Reverse Concert BD 1
38	Shime Taiko	----	Pick Scrape	Reverse Power Kick 1
39	Atarigane	----	High Q	Reverse Electric Kick 1
40	Hyoushigi	Standard 1 Kick 1	Step	Reverse Snare 1
41	Ohkawa	Standard 1 Kick 2	Scratch Push [EXC7]	Reverse Snare 2
42	High Kotsuzumi	Standard 2 Kick 1	Scratch Pull [EXC7]	Reverse Standard set1 Snare 1
43	Low Kotsuzumi	Standard 2 Kick 2	Sticks	Reverse Tight Snare
44	Bar Gu	Kick 1	Square Click	Reverse Dance Snare
45	Big Gong	Kick 2	Metronome Click	Reverse 808 Snare
46	Small Gong	Soft Kick	Metronome Bell	Reverse Tom1
47	Bend Gong	Jazz Kick 1	Guitar Fret Noise	Reverse Tom2
C3 48	Thai Gong	Jazz Kick 2	Guitar Cutting Noise Up	Reverse Sticks
49	Rama Cymbal	Concert BD	GuitarCutting Noise Down	Reverse Slap
50	Gamelan Gong	Room Kick 1	String Slap of Double Bass	Reverse Cymbal1
51	Udo Short [EXC1]	Room Kick 2	Fl.Key Click	Reverse Cymbal2
52	Udo Long [EXC1]	Power Kick 1	Laughing	Reverse Open Hi-hat
53	Udo Slap	Power Kick 2	Scream	Reverse Ride Cymbal
54	Bendir	Electric Kick 2	Punch	Reverse CR-78 OHH
55	Req Dum	Electric Kick 1 *	Heart Beat	Reverse Closed Hi-hat
56	Req Tik	Electric Kick	Footsteps1	Reverse Gong
57	Tabla Te	808 Bass Drum	Footsteps2	Reverse Bell Tree
58	Tabla Na	909 Bass Drum	Applause *	Reverse Guiro
59	Tabla Tun	Dance Kick	Door Creaking	Reverse Bendir
C4 60	Tabla Ge	Standard 1 Snare 1	Door	Reverse Gun Shot
61	Tabla Ge Hi	Standard 1 Snare 2	Scratch	Reverse Scratch
62	Talking Drum *	Standard 2 Snare 1	Wind Chimes *	Reverse Laser
63	Bend Talking Drum *	Standard 2 Snare 2	Car-Engine	Key Click
64	Caxixi	Tight Snare	Car-Stop	Tekno Thip
65	Djembe	Concert Snare	Car-Pass	Pop Drop
66	Djembe Rim	Jazz Snare 1	Car-Crash *	Woody Slap
67	Timbales Low	Jazz Snare 2	Siren	Distortion Kick *
68	Timbales Paila	Room Snare 1	Train	Syn.Drop
69	Timbales High	Room Snare 2	Jetplane *	Reverse High Q
70	Cowbell	Power Snare 1	Helicopter	Pipe
71	Hi Bongo	Power Snare 2	Starship *	Ice Block
C5 72	Low Bongo	Gated Snare	Gun Shot	Digital Tambourine *
73	Mute Hi Conga	Dance Snare 1	Machine Gun	Alias
74	Open Hi Conga	Dance Snare 2	Lasergun	Modulated Bell
75	Mute Low Conga	Disco Snare	Explosion *	Spark
76	Conga Slap	Electric Snare2	Dog	Metalic Percussion
77	Open Low Conga	House Snare *	Horse-Gallop	Velocity Noise FX
78	Conga Slide *	Electric Snare 1	Birds *	Stereo Noise Clap *
79	Mute Pandiero	Electric Snare 3 *	Rain	Swish
80	Open Pandiero	808 Snare 1	Thunder	Slappy *
81	Open Surdo [EXC2]	808 Snare 2 *	Wind	Voice Ou
82	Mute Surdo [EXC2]	909 Snare 1	Seashore	Voice Au
83	Tamborim	909 Snare 2 *	Stream *	Hoo
C6 84	High Agogo	Brush Tap1	Bubble *	Tape Stop1 *
85	Low Agogo	Brush Tap2	Kitty	Tape Stop2 *
86	Shaker	Brush Slap1	Bird2	Missile *
87	High Whistle [EXC3]	Brush Slap2	Growl	Space Bird
88	Low Whistle [EXC3]	Brush Slap3	Applause2 *	Flying Monster
89	Mute Cuica [EXC4]	Brush Swirl1	Telephone1	----
90	Open Cuica [EXC4]	Brush Swirl2	Telephone2	----
91	Mute Triangle [EXC5]	Brush Long Swirl	----	----
92	Open Triangle [EXC5]	----	----	----
93	Short Guiro [EXC6]	----	----	----
94	Long Guiro [EXC6]	----	----	----
95	Cabasa Up	----	----	----
C7 96	Cabasa Down	----	----	----
97	Claves	----	----	----
98	High Wood Block	----	----	----
99	Low Wood Block	----	----	----

Note Number

PC : Program Number (Drum Set Number)
 ---- : No sound
 * : Tones which are created using two voices

---- : Same as the percussion sound of "STANDARD" (PC1).
 [EXC] : Percussion sound of the same number will not be heard at the same time.

SC-88 Drum set (3)

	PC 1 / PC 33 STANDARD Set / JAZZ Set	PC 9 ROOM Set	PC 17 POWER Set	PC 25 ELECTRONIC Set	PC 26 TR-808 Set	PC 41 BRUSH Set	PC 49 ORCHESTRA Set
25	---	---	---	---	---	---	---
26	---	---	---	---	---	---	---
27	High Q	←	←	←	←	←	Closed Hi-hat [EXC1]
28	Slap	←	←	←	←	←	Pedal Hi-hat [EXC1]
29	Scratch Push	←	←	←	←	←	Open Hi-hat [EXC1]
30	Scratch Pull	←	←	←	←	←	Ride Cymbal1
31	Sticks	←	←	←	←	←	←
32	Square Click	←	←	←	←	←	←
33	Metronome Click	←	←	←	←	←	←
34	Metronome Bell	←	←	←	←	←	←
35	Kick Drum2 / Jazz BD2	←	←	←	←	Jazz BD2	Concert BD2
36	Kick Drum1 / Jazz BD1	←	MONDO Kick	Elec BD	808 Bass Drum	Jazz BD1	Concert BD1
37	Side Stick	←	←	←	808 Rim Shot	←	←
38	Snare Drum1	←	Gated SD	Elec SD	808 Snare Drum	Brush Tap	Concert SD
39	Hand Clap	←	←	←	←	Brush Slap	Castanets
40	Snare Drum2	←	←	Gated SD	←	Brush Swirl	Concert SD
41	Low Tom2	Room Low Tom2	Room Low Tom2	Elec Low Tom2	808 Low Tom2	←	Timpani F
42	Closed Hi-hat [EXC1]	←	←	←	808 CHH [EXC1]	←	Timpani F#
43	Low Tom1	Room Low Tom1	Room Low Tom1	Elec Low Tom1	808 Low Tom1	←	Timpani G
44	Pedal Hi-hat [EXC1]	←	←	←	808 CHH [EXC1]	←	Timpani G#
45	Mid Tom2	Room Mid Tom2	Room Mid Tom2	Elec Mid Tom2	808 Mid Tom2	←	Timpani A
46	Open Hi-hat [EXC1]	←	←	←	808 OHH [EXC1]	←	Timpani A#
47	Mid Tom1	Room Mid Tom1	Room Mid Tom1	Elec Mid Tom1	808 Mid Tom1	←	Timpani B
48	High Tom2	Room Hi Tom2	Room Hi Tom2	Elec Hi Tom2	808 Hi Tom2	←	Timpani c
49	Crash Cymbal1	←	←	←	808 Cymbal	←	Timpani c#
50	High Tom1	Room Hi Tom1	Room Hi Tom1	Elec Hi Tom1	808 Hi Tom1	←	Timpani d
51	Ride Cymbal1	←	←	←	←	←	Timpani d#
52	Chinese Cymbal	←	←	Reverse Cymbal	←	←	Timpani e
53	Ride Bell	←	←	←	←	←	Timpani f
54	Tambourine	←	←	←	←	←	←
55	Splash Cymbal	←	←	←	←	←	←
56	Cowbell	←	←	←	808 Cowbell	←	←
57	Crash Cymbal2	←	←	←	←	←	Concert Cymbal2
58	Vibra-slap	←	←	←	←	←	←
59	Ride Cymbal2	←	←	←	←	←	Concert Cymbal1
60	High Bongo	←	←	←	←	←	←
61	Low Bongo	←	←	←	←	←	←
62	Mute High Conga	←	←	←	808 High Conga	←	←
63	Open High Conga	←	←	←	808 Mid Conga	←	←
64	Low Conga	←	←	←	808 Low Conga	←	←
65	High Timbale	←	←	←	←	←	←
66	Low Timbale	←	←	←	←	←	←
67	High Agogo	←	←	←	←	←	←
68	Low Agogo	←	←	←	←	←	←
69	Cabasa	←	←	←	←	←	←
70	Maracas	←	←	←	808 Maracas	←	←
71	Short Hi Whistle [EXC2]	←	←	←	←	←	←
72	Long Low Whistle [EXC2]	←	←	←	←	←	←
73	Short Guiro	←	←	←	←	←	←
74	Long Guiro	←	←	←	←	←	←
75	Claves	←	←	←	808 Claves	←	←
76	High Wood Block	←	←	←	←	←	←
77	Low Wood Block	←	←	←	←	←	←
78	Mute Cuica [EXC4]	←	←	←	←	←	←
79	Open Cuica [EXC4]	←	←	←	←	←	←
80	Mute Triangle [EXC5]	←	←	←	←	←	←
81	Open Triangle [EXC5]	←	←	←	←	←	←
82	Shaker	←	←	←	←	←	←
83	Jingle Bell	←	←	←	←	←	←
84	Bell Tree	←	←	←	←	←	←
85	Castanets	←	←	←	←	←	←
86	Mute Surdo [EXC6]	←	←	←	←	←	←
87	Open Surdo [EXC6]	←	←	←	←	←	←
88	---	---	---	---	---	---	Applause *
89	---	---	---	---	---	---	---
90	---	---	---	---	---	---	---
91	---	---	---	---	---	---	---
92	---	---	---	---	---	---	---
93	---	---	---	---	---	---	---
94	---	---	---	---	---	---	---
95	---	---	---	---	---	---	---
96	---	---	---	---	---	---	---
97	---	---	---	---	---	---	---
98	---	---	---	---	---	---	---
99	---	---	---	---	---	---	---

↑
Note Number

PC : Program Number (Drum Set Number)
 --- : No sound
 * : Tones which are created using two voices

← : Same as the percussion sound of "STANDARD" (PC1).
 [EXC1]: Percussion sound of the same number will not be heard at the same time.

SC-55 Drum set (2)

	PC 57	PC 128
	SFX Set	CM-64/32L Set
C2 35	---	CM Kick Drum
	---	CM Kick Drum
36	---	CM Rim Shot
37	---	CM Snare Drum
38	---	CM Snare Drum
39	High Q	CM Hand Clap
40	Slap	CM Electronic Snare Drum
41	Scratch Push [EXC7]	CM Acoustic Low Tom
42	Scratch Pull [EXC7]	CM Closed High Hat [EXC1]
43	Sticks	CM Acoustic Low Tom
44	Square Click	CM Open Hi-Hat2
45	Metronome Click	CM Acoustic Middle Tom
46	Metronome Bell	CM Open Hi-Hat1 [EXC1]
47	Guitar Fret Noise	CM M.TomAcoustic Middle Tom
C3 48	Guitar cuttingnoise/up	CM Acoustic High Tom
49	Guitar cutting noise/down	CM Crash Cymbal
50	String slap of double bass	CM Acoustic High Tom
51	Fl.Key Click	CM Ride Cymbal
52	Laughing	---
	Scream	---
53	54 Punch	CM Tambourine
55	Heart Beat	---
56	Footsteps1	CM Cowbell
57	Footsteps2	---
58	Applause *	---
59	Door Creaking	---
C4 60	Door	CM High Bongo
61	Scratch	CM Low Bongo
62	Wind Chimes *	CM Mute High Conga
63	Car-Engine	CM High Conga
64	Car-Stop	CM Low Conga
	Car-Pass	CM High Timbale
65	66 Car-Crash *	CM Low Timbale
67	Siren	CM High Agogo
68	Train	CM Low Agogo
69	Jetplane *	CM Cabasa
70	Helicopter	CM Maracas
71	Starship *	CM Short Whistle
C5 72	Gun Shot	CM Long Whistle
73	Machine Gun	CM Vibrato Slap
74	Lasergun	---
75	Explosion *	CM Claves
76	Dog	Laughing
	Horse-Gallop	Scream
77	78 Birds *	Punch
79	Rain *	Heart Beat
80	Thunder	Footsteps1
81	Wind	Footsteps2
82	Seashore	Applause *
83	Stream *	Creaking
C6 84	Bubble *	Door
85	---	Scratch
86	---	Wind Chimes *
87	---	Car-Engine
88	---	Car-Stop
	---	Car-Pass
89	---	Car-Crash *
90	---	Siren
91	---	Train
92	---	Jetplane *
93	---	Helicopter
94	---	Starship *
95	---	Gun Shot
C7 96	---	Machine Gun
97	---	Lasergun
98	---	Explosion *
99	---	Dog
100	---	Horse-Gallop
101	---	Birds *
102	---	Rain *
103	---	Thunder
104	---	Wind
105	---	SeaShore
106	---	Stream *
107	---	Bubble *
C8 108	---	Bubble *

↑
Note Number

PC : Program Number (Drum Set Number)
 --- : No sound
 * : Tones which are created using two voices

--- : Same as the percussion sound of "STANDARD" (PC1).
 [EXC]: Percussion sound of the same number will not be heard at the same time.

Switching between the SC-88 map and SC-55 map
 Press the front panel button [SC-55] to make the indicator light, and the SC-55 map will be selected. (参 p.2-3)
 You can also use MIDI Bank Select messages to switch between the SC-88 map and SC-55 map. (参 p.5-9)

The SC-88 has additional functions and parameters which were not found on previous GS format sound sources. These functions and parameters are marked as [88]. If MIDI messages marked as [88] are transmitted to a different GS format sound source, it is possible that these messages may not be received.

Section 1. Receive data

Channel voice messages

Note off

Status	2nd byte	3rd byte
8nH	kkH	vvH
9nH	kkH	00H

n=MIDI channel number : 0H - FH (ch.1 - ch.16)
 kk=note number : 00H - 7FH (0 - 127)
 vv=velocity : 00H - 7FH (0 - 127)

* For Drum Parts, these messages are received by each Instrument when Rx.NOTE OFF = ON.

* The velocity values of Note Off messages are ignored.

Note on

Status	2nd byte	3rd byte
9nH	kkH	vvH

n=MIDI channel number : 0H - FH (ch.1 - ch.16)
 kk=note number : 00H - 7FH (0 - 127)
 vv=velocity : 01H - 7FH (1 - 127)

* Not received when Rx.NOTE MESSAGE = OFF. (Initial value is ON)

* For Drum Parts, not received when Rx.NOTE ON = OFF for each Instrument.

Polyphonic Key Pressure

Status	2nd byte	3rd byte
AnH	kkH	vvH

n=MIDI channel number : 0H - FH (ch.1 - ch.16)
 kk=note number : 00H - 7FH (0 - 127)
 vv=value : 00H - 7FH (0 - 127)

* Not received when Rx.POLY PRESSURE (PA) = OFF. (Initial value is ON)

* The resulting effect is determined by System Exclusive messages. With the initial settings, there will be no effect.

Control Change

* When Rx.CONTROL CHANGE = OFF, all control change messages except for Channel Mode messages will be ignored.

* The value specified by a Control Change message will not be reset even by a Program Change, etc.

Bank Select (Controller number 0,32)

Status	2nd byte	3rd byte
BnH	00H	mmH
BnH	20H	llH

[88]

n=MIDI channel number : 0H - FH (ch.1 - ch.16)
 mm=Bank number MSB : 00H - 7FH (GS Variation number 0 - 127) Initial value = 00H
 ll=Bank number LSB : 00H - 02H (MAP) Initial value = 00H

* Not received when Rx.BANK SELECT = OFF

* When "GM System On" is received, Rx.BANK SELECT will be set OFF, and Bank Select will not be received.

* When "GS Reset" is received, Rx.BANK SELECT will be set ON.

* When Rx.BANK SELECT LSB = OFF, Bank number LSB will be handled as 00H regardless of the received value.

* Bank Select processing will be suspended until a Program Change message is received.

* The GS format "Variation number" is the value of the Bank Select MSB (Controller number 0) expressed in decimal.

* The SC-88 recognizes the Bank Select LSB (Controller number 32) as a flag for switching between the SC-88MAP and the SC-55MAP. With a Bank Select LSB of 00H, the map selected by the front panel SC-55MAP button will be selected. With a LSB of 01H, the SC-55MAP will be selected. With a LSB of 02H, the SC-88MAP will be selected.

* Some other GS devices do not recognize the Bank Select LSB (Controller number 32).

Modulation (Controller number 1)

Status	2nd byte	3rd byte
BnH	01H	vvH

n=MIDI channel number : 0H - FH (ch.1 - ch.16)
 vv=Modulation depth : 00H - 7FH (0 - 127)

* Not received when Rx.MODULATION = OFF. (Initial value is ON)

* The resulting effect is determined by System Exclusive messages. With the initial settings, this is Pitch Modulation Depth.

Portamento Time (Controller number 5)

Status	2nd byte	3rd byte
BnH	05H	vvH

n=MIDI channel number : 0H - FH (ch.1 - ch.16)
 vv=Portamento Time : 00H - 7FH (0 - 127) Initial value = 00H (0)

* This adjusts the rate of pitch change when Portamento is on or when using the Portamento Control. A value of 0 results in the fastest change.

Data Entry (Controller number 6,38)

Status	2nd byte	3rd byte
BnH	06H	mmH
BnH	26H	llH

n=MIDI channel number : 0H - FH (ch.1 - ch.16)
 mm,ll= the value of the parameter specified by RPN/NRPN

Volume (Controller number 7)

Status	2nd byte	3rd byte
BnH	07H	vvH

n=MIDI channel number : 0H - FH (ch.1 - ch.16)
 vv=Volume : 00H - 7FH (0 - 127) Initial value = 64H (100)

* Volume messages are used to adjust the volume balance of each Part.

* This message is not received when Rx.VOLUME = OFF. (Initial value is ON)

Pan (Controller number 10)

Status	2nd byte	3rd byte
BnH	0AH	vvH

n=MIDI channel number : 0H - FH (ch.1 - ch.16)
 vv=pan : 00H - 40H - 7FH (Left - Center - Right) Initial value = 40H (Center)

* The stereo position can be adjusted over 127 steps.

* For Rhythm Parts, this is a relative adjustment of each Instrument's pan setting.

* This message is not received when Rx.PANPOT = OFF. (Initial value is ON)

Expression (Controller number 11)

Status	2nd byte	3rd byte
BnH	0BH	vvH

n=MIDI channel number : 0H - FH (ch.1 - ch.16)
 vv=Expression : 00H - 7FH (0 - 127) Initial value = 7FH (127)

* This message adjusts the volume of the part. It can be used independently from Volume messages. Expression messages are used for musical expression within a performance; e.g., expression pedal movements, crescendo and decrescendo.

* This message is not received when Rx.EXPRESSION = OFF. (Initial value is ON)

Hold 1 (Controller number 64)

Status	2nd byte	3rd byte
BnH	40H	vvH

n=MIDI channel number : 0H - FH (ch.1 - ch.16)
 vv=Control value : 00H - 7FH (0 - 127) 0-63=OFF 64-127=ON

* This message is not received when Rx.HOLD1 = OFF. (Initial value is ON)

Portamento (Controller number 65)

Status	2nd byte	3rd byte
BnH	41H	vvH

n=MIDI channel number : 0H - FH (ch.1 - ch.16)
 vv=Control value : 00H - 7FH (0 - 127) 0-63=OFF 64-127=ON

* This message is not received when Rx.PORTAMENTO = OFF. (Initial value is ON)

○ **Sostenuto** (Controller number 66)

Status 2nd byte 3rd byte
BnH 42H vvH

n=MIDI channel number : 0H - FH (ch.1 - ch.16)
vv=Control value : 00H - 7FH (0 - 127) 0-63=OFF 64-127=ON

* This message is not received when Rx.SOSTENUTO = OFF. (Initial value is ON)

○ **Soft** (Controller number 67)

Status 2nd byte 3rd byte
BnH 43H vvH

n=MIDI channel number : 0H - FH (ch.1 - ch.16)
vv=Control value : 00H - 7FH (0 - 127) 0-63=OFF 64-127=ON

* This message is not received when Rx.SOFT = OFF. (Initial value is ON)

○ **Portamento control** (Controller number 84)

Status 2nd byte 3rd byte
BnH 54H kkH

n=MIDI channel number : 0H - FH (ch.1 - ch.16)
kk=source note number : 00H - 7FH (0 - 127)

* A Note-on received immediately after a Portamento Control message will change continuously in pitch, starting from the pitch of the Source Note Number.0

* If a voice is already sounding for a note number identical to the Source Note Number, this voice will continue sounding (i.e., legato) and will, when the next Note-on is received, smoothly change to the pitch of that Note-on.

* The rate of the pitch change caused by Portamento Control is determined by the Portamento Time value.

Example 1)

On MIDI	Description	Result
90 3C 40	Note on C4	C4 on
80 54 3C	Portamento Control from C4	no change (C4 voice still sounding)
90 40 40	Note on E4	Glide from C4 to E4
80 3C 40	Note off C4	no change
80 40 40	Note off E4	E4 off

Example 2)

On MIDI	Description	Result
B0 54 3C	Portamento Control from C4	no change
90 40 40	Note on E4	E4 on with glide from C4
80 40 40	Note off E4	E4 off

○ **Effect 1 (Reverb Send Level)** (Controller number 91)

Status 2nd byte 3rd byte
BnH 5BH vvH

n=MIDI channel number : 0H - FH (ch.1 - ch.16)
vv=Control value : 00H - 7FH (0 - 127) Initial value = 28H (40)

* This message adjusts the Reverb Send Level of each Part.

○ **Effect 3 (Chorus Send Level)** (Controller number 93)

Status 2nd byte 3rd byte
BnH 5DH vvH

n=MIDI channel number : 0H - FH (ch.1 - ch.16)
vv=Control value : 00H - 7FH (0 - 127) Initial value = 00H (0)

* This message adjusts the Chorus Send Level of each Part.

○ **Effect 4 (Delay Send Level)** (Controller number 94) [88]

Status 2nd byte 3rd byte
BnH 5EH vvH

n=MIDI channel number : 0H - FH (ch.1 - ch.16)
vv=Control value : 00H - 7FH (0 - 127) Initial value = 00H (0)

* This message adjusts the Delay Send Level of each Part.
* Some other GS devices may not recognize this message.
* Delay cannot be used in MODE-2 (Double Module mode).

○ **NRPN MSB/LSB** (Controller number 98,99)

Status 2nd byte 3rd byte
BnH 63H mmH
BnH 62H llH

n=MIDI channel number : 0H - FH (ch.1 - ch.16)
mm=upper byte of the parameter number specified by NRPN
ll=lower byte of the parameter number specified by NRPN

* When "GM System On" is received, Rx.NRPN will be set OFF, and NRPN will not be received. When "GS Reset" or Rx.NRPN = ON is received, NRPN can be received.

* The value set by NRPN will not be reset even if Program Change or Reset All Controllers is received.

NRPN

The NRPN (Non Registered Parameter Number) message allows an extended range of control changes to be used, letting you use control functions which are not part of the MIDI Specification. To use these messages, you must first use NRPN MSB and NRPN LSB messages to specify the parameter to be controlled, and then use Data Entry messages to specify the value of the specified parameter. Once an NRPN parameter has been specified, all Data Entry messages received on that channel will modify the value of that parameter. To prevent accidents, it is recommended that you set RPN Null (RPN Number = 7FH/7Fh) when you have finished setting the value of the desired parameter.

On the SC-88, NRPN can be used to modify sound parameters, etc.

Handwritten: * On the SC-88, NRPN can be used to modify sound parameters, etc.

NRPN MSB	NRPN LSB	Function and range
01H 08H	mmH	Vibrato Rate (relative change) mm: 00H - 40H - 7FH (-64 - 0 - +63)
01H 09H	mmH	Vibrato Depth (relative change) mm: 00H - 40H - 7FH (-64 - 0 - +63)
01H 0AH	mmH	Vibrato Delay (relative change) mm: 00H - 40H - 7FH (-64 - 0 - +63)
01H 20H	mmH	TVF Cutoff Frequency (relative change) mm: 00H - 40H - 7FH (-64 - 0 - +63)
01H 21H	mmH	TVF Resonance (relative change) mm: 00H - 40H - 7FH (-64 - 0 - +63)
01H 63H	mmH	TVF&TVA Envelope Attack Time (relative change) mm: 00H - 40H - 7FH (-64 - 0 - +63)
01H 64H	mmH	TVF&TVA Envelope Decay Time (relative change) mm: 00H - 40H - 7FH (-64 - 0 - +63)
01H 66H	mmH	TVF&TVA Envelope Release Time (relative change) mm: 00H - 40H - 7FH (-64 - 0 - +63)
18H rrH	mmH	Drum Instrument Pitch Coarse (relative change) rr: Drum Instrument note number mm: 00H - 40H - 7FH (-64 - 0 - +63 semitone)
1AH rrH	mmH	Drum Instrument TVA Level (absolute change) rr: Drum Instrument note number mm: 00H - 7FH (0 - max)
1CH rrH	mmH	Drum Instrument Panpot (absolute change) rr: Drum Instrument note number mm: 00H, 01H - 40H - 7FH (random, left-center-right)
1DH rrH	mmH	Drum Instrument Reverb Send Level (absolute change) rr: Drum Instrument note number mm: 00H - 7FH (0 - max)
1EH rrH	mmH	Drum Instrument Chorus Send Level (absolute change) rr: Drum Instrument note number mm: 00H - 7FH (0 - max)
1FH rrH	mmH	Drum Instrument Delay Send Level (absolute change) [88] rr: Drum Instrument note number mm: 00H - 7FH (0 - max)

* Data entry LSB (llH) is ignored.
* Parameters marked "relative change" will change relative to the preset value (40H). Even among different GS devices, "relative change" parameters may sometimes differ in the way the sound changes or in the range of change.
* Parameters marked "absolute change" will be set to the absolute value of the parameter, regardless of the preset value.
* It is not possible to simultaneously use both Chorus Send Level and Delay Send Level on a single Drum Instrument.

○ RPN MSB/LSB (Controller number 100,101)

Status	2nd byte	3rd byte
BnH	65H	mmH
BnH	64H	llH

n=MIDI channel number : 0H - FH (ch.1 - ch.16)
 mm=upper byte of parameter number specified by RPN
 ll=lower byte of parameter number specified by RPN

* This message is not received when Rx.RPN = OFF.
 * The value specified by RPN will not be reset even by messages such as Program Change or Reset All Controller.

RPN

The RPN (Registered Parameter Number) message allows an extended range of control changes to be used, letting you use additional control functions which are part of the MIDI Specification. To use these messages, you must first use RPN MSB and RPN LSB messages to specify the parameter to be controlled, and then use Data Entry messages to specify the value of the specified parameter. Once an RPN parameter has been specified, all Data Entry messages received on that channel will modify the value of that parameter. To prevent accidents, it is recommended that you set RPN Null (RPN Number = 7FH/7Fh) when you have finished setting the value of the desired parameter.

On the SC-88, RPN can be used to modify the following parameters.

RPN	Data entry	Explanation
MSB LSB	MSB LSB	
00H 00H	mmH ---	Pitch Bend Sensitivity mm: 00H - 18H (0 - 24 semitones) Initial value = 02H (2 semitones) ll: ignored (processed as 00H) specify up to 2 octaves in semitone steps
00H 01H	mmH llH	Master Fine Tuning mm,ll: 00 00H - 40 00H - 7F 7FH (-100.0+99.99 cents) Refer to 5. Supplementary material, "About tuning".
00H 02H	mmH ---	Master Coarse Tuning mm: 28H - 40H - 58H (-24 - 0 - +24 semitones) ll: ignored (processed as 00H)
7FH 7FH	--- ---	RPN null set condition where RPN and NRPN are unspecified Settings already made will not change. mm,ll: ignored

● Program Change

Status	2nd byte
CnH	ppH

n=MIDI channel number : 0H - FH (ch.1 - ch.16)
 pp=Program number : 00H - 7FH (prog.1 - prog.128)

* This message is not received when Rx.PROGRAM CHANGE = OFF. (Initial value is ON)
 * After a Program Change message is received, the sound will change beginning with the next Note-on. Voices already sounding when the Program Change message was received will not be affected.
 * For Drum Parts, Program Change messages will not be received on bank numbers 129 - 16384 (the value of Control Number 0 is other than 0(00H)).

● Channel Pressure

Status	2nd byte
DnH	vvH

n=MIDI channel number : 0H - FH (ch.1 - ch.16)
 vv=Channel Pressure : 00H - 7FH (0 - 127)

* This message is not received when Rx.CH PRESSURE (CA) = OFF. (Initial value is ON)
 * The resulting effect is determined by System Exclusive messages. With the initial settings there will be no effect.

● Pitch Bend Change

Status	2nd byte	3rd byte
EnH	llH	mmH

n=MIDI channel number : 0H - FH (ch.1 - ch.16)
 mm,ll=Pitch Bend value : 00 00H - 40 00H - 7F 7FH (-8192 - 0 - +8191)

* This message is not received when Rx.PITCH BEND = OFF. (Initial value is ON)
 * The resulting effect is determined by System Exclusive messages. With the initial settings the effect is Pitch Bend.

■ Channel Mode Messages

● All Sounds Off (Controller number 120)

Status	2nd byte	3rd byte
BnH	78H	00H

n=MIDI channel number : 0H - FH (ch.1 - ch.16)

* When this message is received, all currently-sounding notes on the corresponding channel will be turned off immediately.

● Reset All Controllers (Controller number 121)

Status	2nd byte	3rd byte
BnH	79H	00H

n=MIDI channel number : 0H - FH (ch.1 - ch.16)

* When this message is received, the following controllers will be set to their reset values.

Controller	Reset value
Pitch Bend Change	± 0 (center)
Polyphonic Key Pressure	0 (off)
Channel Pressure	0 (off)
Modulation	0 (off)
Expression	127 (max)
Hold 1	0 (off)
Portamento	0 (off)
Sostenuto	0 (off)
Soft	0 (off)
RPN	unset; previously set data will not change
NRPN	unset; previously set data will not change

● All Notes Off (Controller number 123)

Status	2nd byte	3rd byte
BnH	7BH	00H

n=MIDI channel number : 0H - FH (ch.1 - ch.16)

* When All Notes Off is received, all notes on the corresponding channel will be turned off. However if Hold 1 or Sostenuto is on, the sound will be continued until these are turned off.

● OMNI OFF (Controller number 124)

Status	2nd byte	3rd byte
BnH	7CH	00H

n=MIDI channel number : 0H - FH (ch.1 - ch.16)

* The same processing will be carried out as when All Notes Off is received.

● OMNI ON (Controller number 125)

Status	2nd byte	3rd byte
BnH	7DH	00H

n=MIDI channel number : 0H - FH (ch.1 - ch.16)

* The same processing will be carried out as when All Notes Off is received.

● MONO (Controller number 126)

Status	2nd byte	3rd byte
BnH	7EH	mmH

n=MIDI channel number : 0H - FH (ch.1 - ch.16)
 mm=mono number : 00H - 10H (0 - 16)

* The same processing will be carried out as when All Sounds Off and All Notes Off is received, and the corresponding channel will be set to Mode 4 (M=1) regardless of the value of "mono number".

● POLY (Controller number 127)

Status	2nd byte	3rd byte
BnH	7FH	00H

n=MIDI channel number : 0H - FH (ch.1 - ch.16)

* The same processing will be carried out as when All Sounds Off and All Notes Off is received, and the corresponding channel will be set to Mode 3.

■ System Realtime Messages

○ Active Sensing

Status
FEH

* When Active Sensing is received, the unit will begin monitoring the intervals of all further messages. While monitoring, if the interval between messages exceeds 420 ms, the same processing will be carried out as when All Sounds Off, All Notes Off and Reset All Controllers are received, and message interval monitoring will be halted.

■ System Exclusive Messages

Status	Data byte	Status
F0H	iiH, ddH,eeH	F7H

Byte	Explanation
F0H	Exclusive status
41H	ID number (Roland)
dev	Device ID (dev: 00H - 1FH (1 - 32) Initial value is 10H(17))
42H	Model ID (GS)
12H	Command ID (DT1)
40H	Address MSB
00H	Address
7FH	Address LSB
00H	Data (GS reset)
41H	Checksum
F7H	EOX (End Of Exclusive)

FOH : System Exclusive Message status
 ii = ID number : an ID number (manufacturer ID) to indicate the manufacturer whose Exclusive message this is. Roland's manufacturer ID is 41H.
 ID numbers 7EH and 7FH are extensions of the MIDI standard; Universal Non-realtime Messages (7EH) and Universal Realtime Messages (7FH).
 dd,....,ee = data : 00H - 7FH (0 - 127)
 F7H : EOX (End Of Exclusive)

The System Exclusive Messages received by the SC-88 are; messages related to mode settings, Universal Realtime System Exclusive messages, Data Requests (RQ1), and Data Set (DT1).

● System exclusive messages related to mode settings

These messages are used to initialize a device to GS or General MIDI mode, or change the operating mode. When creating performance data, a "Turn General MIDI System On" message should be inserted at the beginning of a General MIDI score, a "GS Reset" message at the beginning of a GS music data, and a "System Mode Set" message at the beginning of data especially for the SC-88. Each song should contain only one mode message as appropriate for the type of data. (Do not insert two or more mode setting messages in a single song.)

"System Mode Set" and "GS Reset" use Roland system exclusive format "Data Set 1 (DT1)". "Turn General MIDI System On" use Universal Non-realtime Message format.

○ Turn General MIDI System On

"General MIDI System On" is a command message that resets the internal settings of the unit to the General MIDI initial state (General MIDI System - Level 1). A General MIDI device that receives this message will automatically be set to the proper condition for correctly playing a General MIDI score.

Status	Data byte	Status
F0H	7EH, 7FH, 09H, 01H	F7H

Byte	Explanation
F0H	Exclusive status
7EH	ID number (Universal Non-realtime Message)
7FH	Device ID (Broadcast)
09H	Sub ID#1 (General MIDI Message)
01H	Sub ID#2 (General MIDI On)
F7H	EOX (End Of Exclusive)

* When this message is received, Rx.BANK SELECT will be OFF and Rx.NRPN will be OFF.

* This message will not be received when Rx.GM On = OFF (P.6-15).

* There must be an interval of at least 50 ms between this message and the next message.

○ GS Reset

GS Reset is a command message that resets the internal settings of a device to the GS initial state. This message appears at the beginning of GS music data, and a GS device that receives this message will automatically be set to the proper state to correctly playback GS music data. If the SC-88 is in MODE-1 (single module mode) all 32 Parts will be initialized. If in MODE-2 (double module mode), only the corresponding 16 Parts will be initialized. In MODE-2 if the receiving MIDI connector for each Part has been changed, this may affect playback from the other MIDI connector. In this case, first perform initialization (page 4-18) before using this command.

Status	Data byte	Status
F0H	41H, dev, 42H, 12H, 40H, 00H, 7FH, 00H, 41H	F7H

Byte	Explanation
F0H	Exclusive status
41H	ID number (Roland)
dev	Device ID (dev: 00H - 1FH (1 - 32) Initial value is 10H(17))
42H	Model ID (GS)
12H	Command ID (DT1)
40H	Address MSB
00H	Address
7FH	Address LSB
00H	Data (GS reset)
41H	Checksum
F7H	EOX (End Of Exclusive)

* When this message is received, Rx.NRPN will be ON.

* This message will not be received if Rx.GS Reset = OFF (P.6-15).

* There must be an interval of at least 50 ms between this message and the next.

○ System Mode Set

[88]

System Mode Set is a message that sets the SC-88 operating mode to MODE-1 (single module mode) or MODE-2 (double module mode). When this message is received, the operating mode will be set, and at the same time all internal parameters (except for the map settings of each Part) will be reset to the initial state.

Status	Data byte	Status
F0H	41H, dev, 42H, 12H, 00H, 00H, 7FH, ddH, sumH	F7H

Byte	Explanation
F0H	Exclusive status
41H	ID number (Roland)
dev	Device ID (dev: 00H - 1FH (1 - 32) Initial value is 10H(17))
42H	Model ID (GS)
12H	Command ID (DT1)
00H	Address MSB
00H	Address
7FH	Address LSB
ddH	Data 00H (MODE-1), 01H (MODE-2)
sumH	Checksum 01H (MODE-1), 00H (MODE-2)
F7H	EOX (End Of Exclusive)

* When this message is received, Rx.NRPN will be set ON.

* This message will not be received when Rx.GS Reset = OFF (P.6-15) or Rx.Sys Mode = OFF (P.6-12).

* There must be an interval of at least 50 ms between this message and the next.

● Universal Realtime System Exclusive Messages

○ Master volume

Status	Data byte	Status
F0H	7FH, 7FH, 04H, 01H, llH, mmH	F7H

Byte	Explanation
F0H	Exclusive status
7FH	ID number (universal realtime message)
7FH	Device ID (Broadcast)
04H	Sub ID#1 (Device Control messages)
01H	Sub ID#2 (Master Volume)
llH	Master volume lower byte
mmH	Master volume upper byte
F7H	EOX (End Of Exclusive)

* The lower byte (llH) of Master Volume will be handled as 00H.

● **Data transmission**

The SC-88 can use Exclusive messages to transmit internal settings to other devices. There are two types of Exclusive data transmission; Individual Parameter Transmission (section 3) in which single parameters are transmitted one by one, and Bulk Dump Transmission (section 4) in which a large amount of data is transmitted at once.

The exclusive message used when transmitting GS format data has a model ID of 42H and a device ID of 10H. (The SC-88 allows you to change the Device ID setting.)

○ **Data request 1 RQ1 (11H)**

This message requests the other device to send data. The Address and Size determine the type and amount of data to be sent. There are two types of request; Individual Parameter Request which requests data for an individual parameter, and Bulk Dump Request which requests a large amount of data at once. In either case, the "Data Request 1 (RQ1)" message format is used, and the Address and Size included in the message determine the type and amount of data that is desired.

For Individual Parameter Request, refer to "3. Individual Parameter Transmission" (p.7-26).

For Bulk Dump Request, refer to "4. Bulk Dump" (p.7-33).

When a Data Request message is received, if the device is ready to transmit data and if the address and size are appropriate, the requested data will be transmitted as a "Data Set 1 (DT1)" message. If not, nothing will be transmitted.

Status	Data byte	Status
F0H	41H, dev, 42H, 11H, aaH, bbH, ccH, ssH, ttH, uuH, sum	F7H
Byte	Explanation	
F0H	Exclusive status	
41H	ID number (Roland)	
dev	Device ID (dev: 00H - 1FH Initial value is 10H)	
42H	Model ID (GS)	
11H	CommandID(RQ1)	
aaH	Address MSB: upper byte of the starting address of the requested data	
bbH	Address : middle byte of the starting address of the requested data	
ccH	Address LSB: lower byte of the starting address of the requested data	
ssH	Size MSB	
ttH	Size	
uuH	Size LSB	
sum	Checksum	
F7H	EOX (End Of Exclusive)	

* The amount of data that can be transmitted at once time will depend on the type of data, and data must be requested using a specific starting address and size. Refer to the Address and Size listed in Section 3 (p.7-26).

* Regarding the checksum please refer to Section 4(p.7-35).

○ **Data set 1 DT1 (12H)**

This is the message that actually performs data transmission, and is used when you wish to transmit the data.

Status	Data byte	Status
F0H	41H, dev, 42H, 12H, aaH, bbH, ccH, ddH, ... eeH, sum	F7H
Byte	Explanation	
F0H	Exclusive status	
41H	ID number (Roland)	
dev	Device ID (dev: 00H - 1FH Initial value is 10H)	
42H	Model ID (GS)	
12H	CommandID(DT1)	
aaH	Address MSB : upper byte of the starting address of the transmitted data	
bbH	Address : middle byte of the starting address of the transmitted data	
ccH	Address LSB : lower byte of the starting address of the transmitted data	
ddH	Data : the actual data to be transmitted. Multiple bytes of data are transmitted starting from the address.	
:	:	
eeH	Data	
sum	Checksum	
F7H	EOX (End Of Exclusive)	

* The amount of data that can be transmitted at one time depends on the type of data, and data can be received only from the specified starting address and size. Refer to the Address and Size given in Section 3 (p.7-26).

* Data larger than 128 bytes must be divided into packets of 128 bytes or less. If "Data Set 1" is transmitted successively, there must be an interval of at least 40 ms between packets.

* Regarding the checksum please refer to section 4 (p.7-33).

Section 2. Transmit data

■ System realtime messages

● **Active sensing**

Status
FEH

* This will be transmitted constantly at intervals of approximately 250ms.

■ System exclusive messages

Data Set 1 (DT1) is the only System Exclusive messages transmitted by GS format sound sources. When an appropriate "Data Request 1 (RQ1)" message is received, the requested internal data will be transmitted.

○ **Data set 1 DT1 (12H)**

Status	Data byte	Status
F0H	41H, dev, 42H, 12H, aaH, bbH, ccH, ddH, ... eeH, sum	F7H
Byte	Explanation	
F0H	Exclusive status	
41H	ID number (Roland)	
dev	Device ID (dev: 00H - 1FH Initial value is 10H)	
42H	Model ID (GS)	
12H	Command ID (DT1)	
aaH	Address MSB: upper byte of the starting address of the data to be sent	
bbH	Address : middle byte of the starting address of the data to be sent	
ccH	Address LSB: lower byte of the starting address of the data to be sent.	
ddH	Data : the actual data to be sent. Multiple bytes of data are transmitted in order starting from the address.	
:	:	
eeH	Data	
sum	Checksum	
F7H	EOX (End Of Exclusive)	

* The amount of data that can be transmitted at one time depends on the type of data, and data will be transmitted from the specified starting address and size. Refer to the Address and Size given in Section 3 (p.7-26).

* Data larger than 128 bytes will be divided into packets of 128 bytes or less, and each packet will be sent at an interval of about 40ms.

* Regarding the checksum please refer to section 4 (p.7-33)

There are two ways in which GS data is transmitted: Individual Parameter Transmission (Section 3) in which individual parameters are transmitted one by one, and Bulk Dump Transmission (Section 4) in which a large amount of data is transmitted at once.

Section 3. Individual Parameter Transmission (Model ID=45H or 42H)

Individual Parameter Transmission transmits data (or requests data) for one parameter as one exclusive message (one packet of "FO....F7").

In Individual Parameter Transmission, you must use the Address and Size listed in the following "Parameter Address Map". Addresses marked at "#" cannot be used as starting addresses.

■ Address Block Map

The address map for Individual Parameter Transmission is as follows.

<Model ID = 45H>

Address(H)Block
 10 00 00 -----
Display data

<Model ID = 42H>

● Port-A
 Address(H)Block
 00 40 00 -----
SYSTEM
20 00 00 -----
USER TONE BANK

21 00 00 -----
USER DRUM SET

40 00 00 ----- 50 00 00 -----
PATCH COMMON #A

40 10 00 ----- 50 10 00 -----
PATCH PART A
(BLOCK 00-0F)

41 00 00 ----- 51 00 00 -----
DRUM SETUP A

* Blocks delineated by dotted lines (: : : :) cannot be accessed in Mode-1 (Single Module mode).

* Blocks listed as "#A" are parameter blocks which are common to the entire device in Mode-1, and valid only for Parts A01 - A16 in Mode-2 (Double Module mode).

● Port-B

Address(H) Block
 00 40 00 -----
SYSTEM
20 00 00 -----
USER TONE BANK

21 00 00 -----
USER DRUM SET

50 00 00 ----- 40 00 00 -----
PATCH COMMON A

50 10 00 ----- 40 10 00 -----
PATCH PART A
(BLOCK 00-0F)

51 00 00 ----- 41 00 00 -----
DRUM SETUP A

* Blocks delineated by dotted lines (: : : :) cannot be accessed in Mode-1 (Single Module mode).

* Blocks listed as "#B" are parameter blocks which are common to the entire device in Mode-1, and valid only for Parts B01 - B16 in Mode-2 (Double Module mode).

■ Parameter address map

The MODEL ID = 42H parameters at address 5* * * * are not given in this map. The parameters for address 5* * * * are the same format as those at address 4* * * *.

< MODEL ID = 45H >

Address(H)	Size(H)	Data(H)	Parameter	Description	Default Value(H)
10 00 00	00 00 20	20-7F	Displayed Letter	32-127(ASCII)	--
10 00 01#					
10 00 02#					
:					
10 00 1F#					

* When this message is received, a character string specified by the data will be temporarily displayed in the INSTRUMENT display area. A character string of 1 to 32 characters can be received. If more than 16 characters are received, the display will automatically be scrolled.

Address(H)	Size(H)	Data(H)	Parameter	Description	Default Value(H)
10 0p 00	00 00 40	00-1F	Displayed Dot Data d00	00-31	--
10 0p 01#			Dot Data d01		
10 0p 02#			Dot Data d02		
10 0p :			Dot Data :		
10 0p 3F#			Dot Data d63		
(p:Page# p=1:Page1, p=2:Page3, p=3:Page5, p=4:Page7, p=5:Page9)					
10 0p 40	00 00 40	00-1F	Displayed Dot Data d00	00-31	--
10 0p 41#			Dot Data d01		
10 0p 42#			Dot Data d02		
10 0p :			Dot Data :		
10 0p 7F#			Dot Data d63		
(p:Page# p=1:Page2, p=2:Page4, p=3:Page6, p=4:Page8, p=5:Page10)					

* When this message is displayed, screen data (16 x 16 dot) corresponding to the bit pattern of the Displayed Dot Data will be stored in the SC-88 internal memory. The correspondence between data and dots is given below. The screen data which is stored can be displayed by transmitting a message for address 10 20 00.

* Only in the case of Page 1, the screen data will be temporarily displayed immediately after this message is received.

bit	4	3	2	1	0	4	3	2	1	0	4	3	2	1	0	4
[* * d00 * *]	[* * d16 * *]	[* * d32 * *]	[* * d48 * *]	[* * d64 * *]	[* * d80 * *]	[* * d96 * *]	[* * d112 * *]	[* * d128 * *]	[* * d144 * *]	[* * d160 * *]	[* * d176 * *]	[* * d192 * *]	[* * d208 * *]	[* * d224 * *]	[* * d240 * *]	[* * d256 * *]
[* * d01 * *]	[* * d17 * *]	[* * d33 * *]	[* * d49 * *]	[* * d65 * *]	[* * d81 * *]	[* * d97 * *]	[* * d113 * *]	[* * d129 * *]	[* * d145 * *]	[* * d161 * *]	[* * d177 * *]	[* * d193 * *]	[* * d209 * *]	[* * d225 * *]	[* * d241 * *]	[* * d257 * *]
[* * d02 * *]	[* * d18 * *]	[* * d34 * *]	[* * d50 * *]	[* * d66 * *]	[* * d82 * *]	[* * d98 * *]	[* * d114 * *]	[* * d130 * *]	[* * d146 * *]	[* * d162 * *]	[* * d178 * *]	[* * d194 * *]	[* * d210 * *]	[* * d226 * *]	[* * d242 * *]	[* * d258 * *]
[* * d03 * *]	[* * d19 * *]	[* * d35 * *]	[* * d51 * *]	[* * d67 * *]	[* * d83 * *]	[* * d99 * *]	[* * d115 * *]	[* * d131 * *]	[* * d147 * *]	[* * d163 * *]	[* * d179 * *]	[* * d195 * *]	[* * d211 * *]	[* * d227 * *]	[* * d243 * *]	[* * d259 * *]
[* * d04 * *]	[* * d20 * *]	[* * d36 * *]	[* * d52 * *]	[* * d68 * *]	[* * d84 * *]	[* * d100 * *]	[* * d116 * *]	[* * d132 * *]	[* * d148 * *]	[* * d164 * *]	[* * d180 * *]	[* * d196 * *]	[* * d212 * *]	[* * d228 * *]	[* * d244 * *]	[* * d260 * *]
[* * d05 * *]	[* * d21 * *]	[* * d37 * *]	[* * d53 * *]	[* * d69 * *]	[* * d85 * *]	[* * d101 * *]	[* * d117 * *]	[* * d133 * *]	[* * d149 * *]	[* * d165 * *]	[* * d181 * *]	[* * d197 * *]	[* * d213 * *]	[* * d229 * *]	[* * d245 * *]	[* * d261 * *]
[* * d06 * *]	[* * d22 * *]	[* * d38 * *]	[* * d54 * *]	[* * d70 * *]	[* * d86 * *]	[* * d102 * *]	[* * d118 * *]	[* * d134 * *]	[* * d150 * *]	[* * d166 * *]	[* * d182 * *]	[* * d198 * *]	[* * d214 * *]	[* * d230 * *]	[* * d246 * *]	[* * d262 * *]
[* * d07 * *]	[* * d23 * *]	[* * d39 * *]	[* * d55 * *]	[* * d71 * *]	[* * d87 * *]	[* * d103 * *]	[* * d119 * *]	[* * d135 * *]	[* * d151 * *]	[* * d167 * *]	[* * d183 * *]	[* * d199 * *]	[* * d215 * *]	[* * d231 * *]	[* * d247 * *]	[* * d263 * *]
[* * d08 * *]	[* * d24 * *]	[* * d40 * *]	[* * d56 * *]	[* * d72 * *]	[* * d88 * *]	[* * d104 * *]	[* * d120 * *]	[* * d136 * *]	[* * d152 * *]	[* * d168 * *]	[* * d184 * *]	[* * d200 * *]	[* * d216 * *]	[* * d232 * *]	[* * d248 * *]	[* * d264 * *]
[* * d09 * *]	[* * d25 * *]	[* * d41 * *]	[* * d57 * *]	[* * d73 * *]	[* * d89 * *]	[* * d105 * *]	[* * d121 * *]	[* * d137 * *]	[* * d153 * *]	[* * d169 * *]	[* * d185 * *]	[* * d201 * *]	[* * d217 * *]	[* * d233 * *]	[* * d249 * *]	[* * d265 * *]
[* * d10 * *]	[* * d26 * *]	[* * d42 * *]	[* * d58 * *]	[* * d74 * *]	[* * d90 * *]	[* * d106 * *]	[* * d122 * *]	[* * d138 * *]	[* * d154 * *]	[* * d170 * *]	[* * d186 * *]	[* * d202 * *]	[* * d218 * *]	[* * d234 * *]	[* * d250 * *]	[* * d266 * *]
[* * d11 * *]	[* * d27 * *]	[* * d43 * *]	[* * d59 * *]	[* * d75 * *]	[* * d91 * *]	[* * d107 * *]	[* * d123 * *]	[* * d139 * *]	[* * d155 * *]	[* * d171 * *]	[* * d187 * *]	[* * d203 * *]	[* * d219 * *]	[* * d235 * *]	[* * d251 * *]	[* * d267 * *]
[* * d12 * *]	[* * d28 * *]	[* * d44 * *]	[* * d60 * *]	[* * d76 * *]	[* * d92 * *]	[* * d108 * *]	[* * d124 * *]	[* * d140 * *]	[* * d156 * *]	[* * d172 * *]	[* * d188 * *]	[* * d204 * *]	[* * d220 * *]	[* * d236 * *]	[* * d252 * *]	[* * d268 * *]
[* * d13 * *]	[* * d29 * *]	[* * d45 * *]	[* * d61 * *]	[* * d77 * *]	[* * d93 * *]	[* * d109 * *]	[* * d125 * *]	[* * d141 * *]	[* * d157 * *]	[* * d173 * *]	[* * d189 * *]	[* * d205 * *]	[* * d221 * *]	[* * d237 * *]	[* * d253 * *]	[* * d269 * *]
[* * d14 * *]	[* * d30 * *]	[* * d46 * *]	[* * d62 * *]	[* * d78 * *]	[* * d94 * *]	[* * d110 * *]	[* * d126 * *]	[* * d142 * *]	[* * d158 * *]	[* * d174 * *]	[* * d190 * *]	[* * d206 * *]	[* * d222 * *]	[* * d238 * *]	[* * d254 * *]	[* * d270 * *]
[* * d15 * *]	[* * d31 * *]	[* * d47 * *]	[* * d63 * *]	[* * d79 * *]	[* * d95 * *]	[* * d111 * *]	[* * d127 * *]	[* * d143 * *]	[* * d159 * *]	[* * d175 * *]	[* * d191 * *]	[* * d207 * *]	[* * d223 * *]	[* * d239 * *]	[* * d255 * *]	[* * d271 * *]
1	2	3	4	5	6	7	8	9	10	11	12	13	14	15	16	

* For example, [- * d00 * -] indicates the five dots in the upper left of the display.

* The bit pattern of bits 4 - 0 (lower 5 bits) of the data byte turns the dots on/off. However in the case of d48 - d63, only bit 4 turns the dot on/off.

```
d00: 0-----
d01: 0-----
      |
d47: 0-----
d48: 0-----
      |
d67: 0-----
```

--: dot is unlit for 0, lit for 1
 --: dot display is not affected whether this is 0 or 1

Address(H)	Size(H)	Data(H)	Parameter	Description	Default Value(H)
10 20 00	00 00 01	00-0A	Display Page	00:Bar Display 01:Page1 : 0A:Page10	--
10 20 01	00 00 01	00-10	Display Time	00-0F	06

* When this message is received, the display (page) specified by Display Page (address 10 20 00) will be displayed for the duration of the time specified by Display Time (address 10 20 01).

○ System parameters [88]

Parameters affecting the entire unit, such as how the two MIDI IN connectors will function, are called System Parameters. System parameters will not be reset even if "GS Reset" or "GM System On" are received.

<MODEL ID = 42H>						
Address(H)	Size(H)	Data(H)	Parameter	Description	Default(H)	Description
00 00 7F	00 00 01	00 - 01	SYSTEM MODE SET [88]	00: MODE-1 (Single module mode) 01: MODE-2 (Double module mode)	00	00 (MODE1)
* Refer to "System exclusive messages related to Mode settings" (p.7-24).						
00 01 00	00 00 01	00 - 01	CHANNEL MSG RX PORT [88]	BLOCK00	00	PORT A
:	:	:	:	:	:	:
00 01 0F	00 00 01	00 - 01	BLOCK0F	PORT A - B	00	PORT A
00 01 10	00 00 01	00 - 01	BLOCK10	PORT A - B	01	PORT B
:	:	:	:	:	:	:
00 01 1F	00 00 01	00 - 01	BLOCK1F	PORT A - B	01	PORT B

* You can modify the receiving MIDI port at which channel messages will be received for each BLOCK. We suggest that normally you use PORT1 for BLOCK01-0F, and PORT2 for BLOCK10-1F. (In this case there is no need to change the setting.)
* Refer to page 7-29 for details of each BLOCK.

● Patch parameters

○ Patch common parameters

In MODE-1 (Single module mode) the SC-88 functions as a single sound source module with 32 Parts. In MODE-2 (Double module mode) it functions as two sound source modules with 16 Parts each. The parameters common to all Parts in each module are called Patch Common parameters.

Address(H)	Size(H)	Data(H)	Parameter	Description	Default Value (H)	Description
40 00 00	00 00 04	0018 - 07E8	MASTER TUNE	-100.0 - +100.0 [cent]	00 04 00 00	0 [cent]
40 00 01#				Use nibblized data.		
40 00 02#						
40 00 03#						
* Refer to section 5. Supplementary material, "About tuning" (p.7-36).						
40 00 04	00 00 01	00 - 7F	MASTER VOLUME (= F0 7F 7F 04 01 00 vv F7)	0 - 127	7F	127
40 00 05	00 00 01	28 - 58	MASTER KEY-SHIFT	-24 - +24 [semitones]	40	0[semitones]
40 00 06	00 00 01	01 - 7F	MASTER PAN	-63 (LEFT) - +63 (RIGHT)	40	0 (CENTER)
40 00 7F	00 00 01	00	(Rx. only) MODE SET		00 = GS Reset	
* Refer to "System exclusive messages related to Mode settings" (p.7-24).						
40 01 00	00 00 10	20 - 7F	PATCH NAME	16 ASCII Characters		
40 01 :#						
40 01 0F#						
40 01 30	00 00 01	0 - 07	REVERB MACRO	00: Room 1	04	Hall 2
			01: Room 2			
			02: Room 3			
			03: Hall 1			
			04: Hall 2			
			05: Plate			
			06: Delay			
			07: Panning Delay			
40 01 31	00 00 01	00 - 07	REVERB CHARACTER	0 - 7	04	04
40 01 32	00 00 01	00 - 07	REVERB PRE-LPF	0 - 7	00	00
40 01 33	00 00 01	00 - 7F	REVERB LEVEL	0 - 127	40	64
40 01 34	00 00 01	00 - 7F	REVERB TIME	0 - 127	40	64
40 01 35	00 00 01	00 - 7F	REVERB DELAY FEEDBACK	0 - 127	00	00
40 01 37	00 00 01	00 - 7F	REVERB PREDELAY TIME [88]	0 - 127[ms]	00	00

* REVERB MACRO is a macro parameter that allows global setting of reverb parameters. When you select the reverb type with REVERB MACRO, each reverb parameter will be set to the most suitable value.

* REVERB CHARACTER is a parameter that changes the reverb algorithm. The value of REVERB CHARACTER corresponds to the REVERB MACRO of the same number.

* In MODE-2 (Double module mode), REVERB PREDELAY TIME cannot be used.

Address(H)	Size(H)	Data(H)	Parameter	Description	Default Value (H)	Description
40 1x 16	00 00 01	28 - 58	PITCH KEY SHIFT	-24 - +24 [semitones]	40	0 [semitones]
40 1x 17	00 00 02	08 - F8	PITCH OFFSET FINE	-12.0 - +12.0 [Hz]	08 00	0 [Hz]
40 1x 18#				Use nibblized data.		
40 1x 19	00 00 01	00 - 7F	PART LEVEL	0 - 127 (=CC# 7)	64	100
40 1x 1A	00 00 01	00 - 7F	VELOCITY SENSE DEPTH	0 - 127	40	64
40 1x 1B	00 00 01	00 - 7F	VELOCITY SENSE OFFSET	0 - 127	40	64
40 1x 1C	00 00 01	00 - 7F	PART PANPOT	-64(RANDOM), -63(LEFT) - +63(RIGHT) (=CC# 10, except RANDOM)	40	0 (CENTER)
40 1x 1D	00 00 01	00 - 7F	KEY RANGE LOW	(C-1) - (G9)	00	C-1
40 1x 1E	00 00 01	00 - 7F	KEY RANGE HIGH	(C-1) - (G9)	7F	G 9
40 1x 1F	00 00 01	00 - 5F	CC1 CONTROLLER NUMBER	0 - 95	10	16
40 1x 20	00 00 01	00 - 5F	CC2 CONTROLLER NUMBER	0 - 95	11	17
40 1x 21	00 00 01	00 - 7F	CHORUS SEND LEVEL	0 - 127 (=CC# 93)	00	0
40 1x 22	00 00 01	00 - 7F	REVERB SEND LEVEL	0 - 127 (=CC# 91)	28	40
40 1x 23	00 00 01	00 - 01	Rx.BANK SELECT	OFF / ON	01(00*)	ON(OFF*)
* When "General MIDI System On" is received, Rx.BANK SELECT will be set OFF. When "GS Reset" or "System Mode Set" is received, it will be set ON.						
40 1x 24	00 00 01	00 - 01	RX BANK SELECT LSB	[88] OFF / ON	01	ON
* When RX BANK SELECT LSB = OFF, Bank Select LSB (8n 20 11) will be treated as 00H regardless of its value.						
40 1x 2A	00 00 02	00 00 - 40 00 - 7F 7F	PITCH FINE TUNE	[88] -100 - 0 - +100 cent (= RPN#1)	0	
40 1x 2B#						
40 1x 2C	00 00 01	00 - 7F	DELAY SEND LEVEL	[88] 0-127 (=CC# 94)	00	0
* This cannot be used in MODE-2 (Double module mode).						
40 1x 30	00 00 01	00 - 7F	TONE MODIFY1	[88] -64 - +63 Vibrato Rate (=NRP# 8)	40	0
40 1x 31	00 00 01	00 - 7F	TONE MODIFY2	[88] -64 - +63 Vibrato Depth (=NRP# 9)	40	0
40 1x 32	00 00 01	00 - 7F	TONE MODIFY3	[88] -64 - +63 TVF Cutoff Freq. (=NRP# 32)	40	0
40 1x 33	00 00 01	00 - 7F	TONE MODIFY4	[88] -64 - +63 TVF Resonance (=NRP# 33)	40	0
40 1x 34	00 00 01	00 - 7F	TONE MODIFY5	[88] -64 - +63 TVF&TVA Env.attack (=NRP# 99)	40	0
40 1x 35	00 00 01	00 - 7F	TONE MODIFY6	[88] -64 - +63 TVF&TVA Env.decay (=NRP# 100)	40	0
40 1x 36	00 00 01	00 - 7F	TONE MODIFY7	[88] -64 - +63 TVF&TVA Env.release (=NRP# 102)	40	0
40 1x 37	00 00 01	00 - 7F	TONE MODIFY8	[88] -64 - +63 Vibrato Delay (=NRP# 10)	40	0
40 1x 40	00 00 0C	00 - 7F	SCALE TUNING C	-64 - +63 [cent]	40	0 [cent]
40 1x 41#		00 - 7F	SCALE TUNING C#	-64 - +63 [cent]	40	0 [cent]
40 1x 42#		00 - 7F	SCALE TUNING D	-64 - +63 [cent]	40	0 [cent]
40 1x 43#		00 - 7F	SCALE TUNING D#	-64 - +63 [cent]	40	0 [cent]
40 1x 44#		00 - 7F	SCALE TUNING E	-64 - +63 [cent]	40	0 [cent]
40 1x 45#		00 - 7F	SCALE TUNING F	-64 - +63 [cent]	40	0 [cent]
40 1x 46#		00 - 7F	SCALE TUNING F#	-64 - +63 [cent]	40	0 [cent]
40 1x 47#		00 - 7F	SCALE TUNING G	-64 - +63 [cent]	40	0 [cent]
40 1x 48#		00 - 7F	SCALE TUNING G#	-64 - +63 [cent]	40	0 [cent]
40 1x 49#		00 - 7F	SCALE TUNING A	-64 - +63 [cent]	40	0 [cent]
40 1x 4A#		00 - 7F	SCALE TUNING A#	-64 - +63 [cent]	40	0 [cent]
40 1x 4B#		00 - 7F	SCALE TUNING B	-64 - +63 [cent]	40	0 [cent]
* SCALE TUNING is a function that allows fine adjustment to the pitch of each note in the octave. The pitch of each identically-named note in all octaves will change simultaneously. A setting of ± 0 cent (40H) is equal temperament (** p.7-36).						
40 2x 00	00 00 01	28 - 58	MOD PITCH CONTROL	-24 - +24 [semitones]	40	0 [semitones]
40 2x 01	00 00 01	00 - 7F	MOD TVF CUTOFF CONTROL	-9600 - +9600 [cent]	40	0 [cent]
40 2x 02	00 00 01	00 - 7F	MOD AMPLITUDE CONTROL	-100.0 - +100.0 [%]	40	0 [%]
40 2x 03	00 00 01	00 - 7F	MOD LFO1 RATE CONTROL	-10.0 - +10.0 [Hz]	40	0 [Hz]
40 2x 04	00 00 01	00 - 7F	MOD LFO1 PITCH DEPTH	0 - 600 [cent]	0A	47 [cent]
40 2x 05	00 00 01	00 - 7F	MOD LFO1 TVF DEPTH	0 - 2400 [cent]	00	0 [cent]
40 2x 06	00 00 01	00 - 7F	MOD LFO1 TVA DEPTH	0 - 100.0 [%]	00	0 [%]
40 2x 07	00 00 01	00 - 7F	MOD LFO2 RATE CONTROL	-10.0 - +10.0 [Hz]	40	0 [Hz]
40 2x 08	00 00 01	00 - 7F	MOD LFO2 PITCH DEPTH	0 - 600 [cent]	00	0 [cent]
40 2x 09	00 00 01	00 - 7F	MOD LFO2 TVF DEPTH	0 - 2400 [cent]	00	0 [cent]
40 2x 0A	00 00 01	00 - 7F	MOD LFO2 TVA DEPTH	0 - 100.0 [%]	00	0 [%]

Address(H)	Size(H)	Data(H)	Parameter	Description	Default Value (H)	Description
40 2x 10	00 00 01	40 - 58	BEND PITCH CONTROL	0 - 24 [semitones]	42	2 [semitones]
40 2x 11	00 00 01	00 - 7F	BEND TVF CUTOFF CONTROL	-9600 - +9600 [cent]	40	0 [cent]
40 2x 12	00 00 01	00 - 7F	BEND AMPLITUDE CONTROL	-100.0 - +100.0 [%]	40	0 [%]
40 2x 13	00 00 01	00 - 7F	BEND LFO1 RATE CONTROL	-10.0 - +10.0 [Hz]	40	0 [Hz]
40 2x 14	00 00 01	00 - 7F	BEND LFO1 PITCH DEPTH	0 - 600 [cent]	00	0 [cent]
40 2x 15	00 00 01	00 - 7F	BEND LFO1 TVF DEPTH	0 - 2400 [cent]	00	0 [cent]
40 2x 16	00 00 01	00 - 7F	BEND LFO1 TVA DEPTH	0 - 100.0 [%]	00	0 [%]
40 2x 17	00 00 01	00 - 7F	BEND LFO2 RATE CONTROL	-10.0 - +10.0 [Hz]	40	0 [Hz]
40 2x 18	00 00 01	00 - 7F	BEND LFO2 PITCH DEPTH	0 - 600 [cent]	00	0 [cent]
40 2x 19	00 00 01	00 - 7F	BEND LFO2 TVF DEPTH	0 - 2400 [cent]	00	0 [cent]
40 2x 1A	00 00 01	00 - 7F	BEND LFO2 TVA DEPTH	0 - 100.0 [%]	00	0 [%]
40 2x 20	00 00 01	28 - 58	CAI PITCH CONTROL	-24 - +24 [semitones]	40	0 [semitones]
40 2x 21	00 00 01	00 - 7F	CAI TVF CUTOFF CONTROL	-9600 - +9600 [cent]	40	0 [cent]
40 2x 22	00 00 01	00 - 7F	CAI AMPLITUDE CONTROL	-100.0 - +100.0 [%]	40	0 [%]
40 2x 23	00 00 01	00 - 7F	CAI LFO1 RATE CONTROL	-10.0 - +10.0 [Hz]	40	0 [Hz]
40 2x 24	00 00 01	00 - 7F	CAI LFO1 PITCH DEPTH	0 - 600 [cent]	00	0 [cent]
40 2x 25	00 00 01	00 - 7F	CAI LFO1 TVF DEPTH	0 - 2400 [cent]	00	0 [cent]
40 2x 26	00 00 01	00 - 7F	CAI LFO1 TVA DEPTH	0 - 100.0 [%]	00	0 [%]
40 2x 27	00 00 01	00 - 7F	CAI LFO2 RATE CONTROL	-10.0 - +10.0 [Hz]	40	0 [Hz]
40 2x 28	00 00 01	00 - 7F	CAI LFO2 PITCH DEPTH	0 - 600 [cent]	00	0 [cent]
40 2x 29	00 00 01	00 - 7F	CAI LFO2 TVF DEPTH	0 - 2400 [cent]	00	0 [cent]
40 2x 2A	00 00 01	00 - 7F	CAI LFO2 TVA DEPTH	0 - 100.0 [%]	00	0 [%]
40 2x 30	00 00 01	28 - 58	PAI PITCH CONTROL	-24 - +24 [semitones]	40	0 [semitones]
40 2x 31	00 00 01	00 - 7F	PAI TVF CUTOFF CONTROL	-9600 - +9600 [cent]	40	0 [cent]
40 2x 32	00 00 01	00 - 7F	PAI AMPLITUDE CONTROL	-100.0 - +100.0 [%]	40	0 [%]
40 2x 33	00 00 01	00 - 7F	PAI LFO1 RATE CONTROL	-10.0 - +10.0 [Hz]	40	0 [Hz]
40 2x 34	00 00 01	00 - 7F	PAI LFO1 PITCH DEPTH	0 - 600 [cent]	00	0 [cent]
40 2x 35	00 00 01	00 - 7F	PAI LFO1 TVF DEPTH	0 - 2400 [cent]	00	0 [cent]
40 2x 36	00 00 01	00 - 7F	PAI LFO1 TVA DEPTH	0 - 100.0 [%]	00	0 [%]
40 2x 37	00 00 01	00 - 7F	PAI LFO2 RATE CONTROL	-10.0 - +10.0 [Hz]	40	0 [Hz]
40 2x 38	00 00 01	00 - 7F	PAI LFO2 PITCH DEPTH	0 - 600 [cent]	00	0 [cent]
40 2x 39	00 00 01	00 - 7F	PAI LFO2 TVF DEPTH	0 - 2400 [cent]	00	0 [cent]
40 2x 3A	00 00 01	00 - 7F	PAI LFO2 TVA DEPTH	0 - 100.0 [%]	00	0 [%]
40 2x 40	00 00 01	28 - 58	CC1 PITCH CONTROL	-24 - +24 [semitones]	40	0 [semitones]
40 2x 41	00 00 01	00 - 7F	CC1 TVF CUTOFF CONTROL	-9600 - +9600 [cent]	40	0 [cent]
40 2x 42	00 00 01	00 - 7F	CC1 AMPLITUDE CONTROL	-100.0 - +100.0 [%]	40	0 [%]
40 2x 43	00 00 01	00 - 7F	CC1 LFO1 RATE CONTROL	-10.0 - +10.0 [Hz]	40	0 [Hz]
40 2x 44	00 00 01	00 - 7F	CC1 LFO1 PITCH DEPTH	0 - 600 [cent]	00	0 [cent]
40 2x 45	00 00 01	00 - 7F	CC1 LFO1 TVF DEPTH	0 - 2400 [cent]	00	0 [cent]
40 2x 46	00 00 01	00 - 7F	CC1 LFO1 TVA DEPTH	0 - 100.0 [%]	00	0 [%]
40 2x 47	00 00 01	00 - 7F	CC1 LFO2 RATE CONTROL	-10.0 - +10.0 [Hz]	40	0 [Hz]
40 2x 48	00 00 01	00 - 7F	CC1 LFO2 PITCH DEPTH	0 - 600 [cent]	00	0 [cent]
40 2x 49	00 00 01	00 - 7F	CC1 LFO2 TVF DEPTH	0 - 2400 [cent]	00	0 [cent]
40 2x 4A	00 00 01	00 - 7F	CC1 LFO2 TVA DEPTH	0 - 100.0 [%]	00	0 [%]
40 2x 50	00 00 01	28 - 58	CC2 PITCH CONTROL	-24 - +24 [semitones]	40	0 [semitones]
40 2x 51	00 00 01	00 - 7F	CC2 TVF CUTOFF CONTROL	-9600 - +9600 [cent]	40	0 [cent]
40 2x 52	00 00 01	00 - 7F	CC2 AMPLITUDE CONTROL	-100.0 - +100.0 [%]	40	0 [%]
40 2x 53	00 00 01	00 - 7F	CC2 LFO1 RATE CONTROL	-10.0 - +10.0 [Hz]	40	0 [Hz]
40 2x 54	00 00 01	00 - 7F	CC2 LFO1 PITCH DEPTH	0 - 600 [cent]	00	0 [cent]
40 2x 55	00 00 01	00 - 7F	CC2 LFO1 TVF DEPTH	0 - 2400 [cent]	00	0 [cent]
40 2x 56	00 00 01	00 - 7F	CC2 LFO1 TVA DEPTH	0 - 100.0 [%]	00	0 [%]
40 2x 57	00 00 01	00 - 7F	CC2 LFO2 RATE CONTROL	-10.0 - +10.0 [Hz]	40	0 [Hz]
40 2x 58	00 00 01	00 - 7F	CC2 LFO2 PITCH DEPTH	0 - 600 [cent]	00	0 [cent]
40 2x 59	00 00 01	00 - 7F	CC2 LFO2 TVF DEPTH	0 - 2400 [cent]	00	0 [cent]
40 2x 5A	00 00 01	00 - 7F	CC2 LFO2 TVA DEPTH	0 - 100.0 [%]	00	0 [%]
40 4x 00	00 00 01	00 - 02	TONE MAP NUMBER [88] (= CC#32): Bank number LSB	MAP 0 - 2 00: SELECTED 01: SC-55 MAP 02: SC-88 MAP	00	
*When "GS Reset" is received, this will be 00: SELECTED.						
40 4x 01	00 00 01	01 - 02	TONE MAP-0 NUMBER [88]	01: SC-55 MAP 02: SC-88 MAP	(02)	
* When TONE MAP NUMBER is 00, this specifies the MAP. This setting will not be reset when the power is turned on or when "GS Reset", "GM System On" or "System Mode Set" is received.						
40 4x 20	00 00 01	00 - 01	EQ ON/OFF [88]	OFF / ON	01	ON
* This turns the EQ (equalizer) on/off. In MODE-2 (Double module mode) it cannot be used.						

● Drum setup parameters

* m: Map number (0 = MAP1, 1 = MAP2)
 * rr: drum part note number (00H - 7FH)

Address(H)	Size(H)	Data(H)	Parameter	Description	Default Value (H)	Description
41 m0 00 I#	00 00 0C	20 - 7F	DRUM MAP NAME	ASCII Character		
41 m0 0B#						
41 m1 rr	00 00 01	00 - 7F	PLAY NOTE NUMBER	Pitch coarse		
41 m2 rr	00 00 01	00 - 7F	LEVEL	TVA level (=CC# 26)		
41 m3 rr	00 00 01	00 - 7F	ASSIGN GROUP NUMBER	Non, 1 - 127		
41 m4 rr	00 00 01	00 - 7F	PANPOT	-64(RANDOM), -63(LEFT) - +63(RIGHT) (=CC# 28, except RANDOM)		
41 m5 rr	00 00 01	00 - 7F	REVERB SEND LEVEL	0.0 - 1.0 Multiplicand of the part reverb level (=CC# 29)		
41 m6 rr	00 00 01	00 - 7F	CHORUS SEND LEVEL	0.0 - 1.0 Multiplicand of the part chorus level (=CC# 30)		
41 m7 rr	00 00 01	00 - 01	Rx. NOTE OFF	OFF / ON		
41 m8 rr	00 00 01	00 - 01	Rx. NOTE ON	OFF / ON		
41 m9 rr	00 00 01	00 - 7F	DELAY SEND LEVEL	[88] 0.0 - 1.0 Multiplicand of the part reverb level (=CC# 31)		

* When the Drum Set is changed, DRUM SETUP PARAMETER values will all be initialized.
 * It is not possible to simultaneously use both Chorus Send Level and Delay Send Level for a single Drum Instrument.

● User Instrument

* b: bank number (0H = GS Variation number 64, 1H = GS Variation number 65)
 * pp: program number (00 - 7F: 1 - 128)

Address(H)	Size(H)	Data(H)	Parameter	Description	Default Value (H)	Description
20 b0 pp	00 00 01	01 - 02	SOURCE TONE# (MAP)	[88] --		
20 b1 pp	00 00 01	00 - 7F	(CC#00: Bank number MSB)	[88] --		
20 b2 pp	00 00 01	00 - 7F	(PG#: Program number)	[88] --		
20 b3 pp	00 00 01	00 - 7F	USER INST MODIFY1-2	[88] -64 - +63	40	0
20 b4 pp	00 00 01	00 - 7F	Vibrato Rate			
20 b4 pp	00 00 01	00 - 7F	USER INST MODIFY2-2	[88] -64 - +63	40	0
			Vibrato Depth			
20 b5 pp	00 00 01	00 - 7F	USER INST MODIFY3-2	[88] -64 - +63	40	0
			TVF Cutoff Freq			
20 b6 pp	00 00 01	00 - 7F	USER INST MODIFY4-2	[88] -64 - +63	40	0
			TVF Resonance			
20 b7 pp	00 00 01	00 - 7F	USER INST MODIFY5-2	[88] -64 - +63	40	0
			TVF&TVA Env.attack			
20 b8 pp	00 00 01	00 - 7F	USER INST MODIFY6-2	[88] -64 - +63	40	0
			TVF&TVA Env.decay			
20 b9 pp	00 00 01	00 - 7F	USER INST MODIFY7-2	[88] -64 - +63	40	0
			TVF&TVA Env.release			
20 bA pp	00 00 01	00 - 7F	USER INST MODIFY8-2	[88] -64 - +63	40	0
			Vibrato Delay			

● User Drum Set

* d: drum set number (0H = User drum set number 65, 1H = GS Variation number 66)
 * rr: drum part note number (00 - 7F)

Address(H)	Size(H)	Data(H)	Parameter	Description	Default Value (H)	Description
21 d0 00 :	00 00 0C	20 - 7F (ASCII 12 characters)	USER DRUM SET NAME	[88] 32 - 127	--	--
21 d0 0B#						
21 d1 rr	00 00 01	00 - 7F	PLAY NOTE	[88] 0 - 127	--	--
21 d2 rr	00 00 01	00 - 7F	LEVEL	[88] 0 - 127	--	--
21 d3 rr	00 00 01	00 - 7F	ASSIGN GROUP	[88] 0 - 127	--	--
21 d4 rr	00 00 01	00 - 7F	PAN	[88] 0 - 127	--	--
21 d5 rr	00 00 01	00 - 7F	REVERB SEND LEVEL	[88] 0 - 127	--	--
21 d6 rr	00 00 01	00 - 7F	CHORUS SEND LEVEL	[88] 0 - 127	--	--
21 d7 rr	00 00 01	00 - 01	RX NOTE OFF	[88] OFF / ON	--	--
21 d8 rr	00 00 01	00 - 01	RX NOTE ON	[88] OFF / ON	--	--
21 d9 rr	00 00 01	00 - 7F	DELAY SEND LEVEL	[88] 0 - 127	--	--
21 dA rr	00 00 01	01 - 02	SOURCE DRUM SET# (MAP)	[88] 1 - 2	--	--
21 dB rr	00 - 7F		(PG#)	[88] 0 - 127	--	--
21 dC rr	00 00 01	00 - 7F	SOURCE NOTE NUMBER	[88] 0 - 127	--	--

Section 4. Bulk Dump

Bulk Dump allows you to transmit a large amount of data at once, and is convenient for storing settings for the entire unit on a computer or sequencer.

To make the SC-88 perform a Bulk Dump transmission, send it a "Bulk Dump Request" message. Bulk Dump Request uses the Data Request 1 (RQ1) format, but unlike when transmitting individual parameters, the "Size" specified by the request message refers not to the size of the data but rather specifies the contents of the data. For the data contents corresponding to each Size, refer to "Parameter Dump."

When the SC-88 receives a Bulk Dump Request, it will transmit a Bulk Dump in the format given below.

The SC-88 is also able to transmit a list of its internal sounds. This function can be used to display a list of sounds on a computer.

■ Parameter dump

○ Parameter dump request (receive only) [88]

This is a command that requests a set of parameter data, and uses "Data Request 1 (RQ1)" format. The Size specifies the requested data contents.

Address: 0C 00 00

Size:	00 00 00 : ALL	request a dump of all parameters
	00 00 01 : ALL 1	use this when not using USER TONE BANK or USER DRUM SET
	00 00 02 : ALL 2	use this when USER TONE BANK, USER DRUM SET and DRUM SETUP settings have not been modified
	00 00 10 : 16-part GS 1	use this when using only 16 Parts
	00 00 11 : 16-part GS 2	use this when using only 16 Parts, and DRUM SETUP settings have not been modified
	00 01 00 : USER TONE BANK (ALL)	request a dump of all USER TONE BANK data
	00 01 40 : USER TONE BANK #64	request a dump of USER TONE BANK #64 data (128 sounds)
	00 01 41 : USER TONE BANK #65	request a dump of USER TONE BANK #65 data (128 sounds)
	00 02 00 : USER DRUM SET (ALL)	request a dump of all USER DRUM SET data
	00 02 40 : USER DRUM SET #64	request a dump of USER DRUM SET #64 data
	00 02 41 : USER DRUM SET #65	request a dump of USER DRUM SET #65 data

Example) Dump request for all parameters: F0 41 DEV 42 11 0C 00 00 00 00 74 F7

Normally, using ALL (00 00 00) provides the greatest predictability, but the amount of data is very large, and transmission requires approximately 20 seconds. In order to reduce transmission time and data volume, we suggest that you request a dump only of the necessary data. Panel button operations allow you to transmit dumps of ALL, ALL 1, 16-part GS 1, USER TONE BANK(ALL), and USER DRUM SET(ALL).

○ Parameter dump [88]

When a Parameter Dump Request is received, or when panel operations initiate a dump transmission, the following data will be transmitted in "Data Set 1" format.

Address	Description	Number of packets	16-part USER TONE BANK USER DRUM SET														
			ALL	ALL1	ALL2	GS1	GS2	ALL	#64	#65	ALL	#64	#65				
08 00 00 - 08 00 7F	SETUP	1	○	○	○	○	○										
28 00 00 - 28 0A 7F	USER TONE BANK #64	11	○							○	○						
28 10 00 - 28 1A 7F	USER TONE BANK #65	11	○							○		○					
29 00 00 - 29 0B 0F	USER DRUM SET #65	12	○										○	○			
29 10 00 - 29 1B 0F	USER DRUM SET #66	12	○										○				○
48 1D 10 - 48 26 0F	PATCH EXTENSION A	9	○	○	○		○	○									
48 00 00 - 48 1D 0F	SYSTEM/PATCH A	10	○	○	○		○	○									
49 00 00 - 49 1F 7F	DRUM SETUP A	32	○	○			○										
58 1D 10 - 58 26 0F	PATCH EXTENSION B	9	○	○	○												
58 00 00 - 58 1D 0F	SYSTEM/PATCH B	10	○	○	○												
59 00 00 - 59 1F 7F	DRUM SETUP B	32	○	○													

This table lists the data contents that will be transmitted when panel buttons are used to request a dump, or when a Parameter Dump Request is received at MIDI IN A. When a Parameter Dump Request is received at MIDI IN B, A and B will be reversed for PATCH EXTENSION, SYSTEM/PATCH and DRUM SETUP.

- * When data dumped by the SC-88 is reloaded into the SC-88, be aware that the data may not be set correctly if the transmission order of the packets is changed, if the time interval between packets is changed, or if other messages are inserted between packets.
- * The Parameter Dump data of the SC-88 includes data for GS format compatible devices, and this data is compatible in both directions. However, depending on the settings of parameters which are newly extended on the SC-88, the musical result may differ.
- * If the SC-88 does not operate correctly with Bulk Dump data from another GS format compatible device, first initialize the SC-88 (p.4-18) before retransmitting the data.
- * When another GS format compatible device receives Parameter Dump data that was transmitted by the SC-88, it may display a message such as "Address Error", but this is because the parameter addresses newly extended on the SC-88 were not recognized by the other device. Parameters which could be recognized by that device have been correctly set.

■umping a list of internal sounds

● Instrument list dump [88]

○ Instrument list dump request (request only)

This command requests a bulk dump of a list of the preset sounds (Instruments) in internal memory, and uses "Data Request 1 (RQ1)" format. The Size specifies the contents of the requested data.

Address: 0C 00 01
 Size: 00 00 00 : ALL
 00 00 01 : SC-55 MAP
 00 00 02 : SC-88 MAP
 00 mm bb mm = MAP# 01 - 02 (01 = SC-55 MAP, 02 = SC-88 MAP)
 bb = BANK# 00 - 7F

○ Instrument list dump (transmit only) [88]

When Instrument List Dump Request is received, or when a dump operation is performed from the front panel, the sound names of the specified map will be transmitted continuously in the format given below, where 16 bytes are used for each sound name. The Address of the transmitted data is 0C 00 01 for all packets.

User bank sound names are not transmitted in a SC-88 MAP Instrument List dump.

```
DUMP FORMAT:
  0 1 2 3 4 5 6 7 8 9 A B C D E F
-----
1CC0|MAP|PC|100| TONE NAME(ASCII 12 characters) |
-----
CC0 : Variation number
MAP : MAP number 01 = SC-55 MAP, 02 = SC-88 MAP
PC : Program number
```

● Drum set list dump

○ Drum set list dump request (receive only) [88]

This command requests a bulk dump transmission of a list of Preset Drum Sets in internal memory, and uses "Data Request 1 (RQ1)" format. The Size specifies the desired data contents.

Address: 0C 00 02
 Size: 00 00 00 : ALL
 00 00 01 : SC-55 MAP
 00 00 02 : SC-88 MAP

○ Drum set list dump (transmit only) [88]

When a Drum Set Dump request is received, or when panel operations initiate a dump, the Drum Set names of the specified MAP will be transmitted successively in the format given below, where 16 bytes are used for each sound. The Address of the transmitted data will be 0C 00 02 for each packet.

```
DUMP FORMAT:
  0 1 2 3 4 5 6 7 8 9 A B C D E F
-----
100|MAP|PC|100| DRUM TONE NAME(ASCII 12 characters) |
-----
MAP : MAP number 01 = SC-55 MAP, 02 = SC-88 MAP
PC : Program number
```

● Drum instrument list dump

○ Drum instrument list dump request (receive only) [88]

This command requests a bulk dump transmission of the Instrument list of an internal Preset Drum Sets, and uses "Data Request 1 (RQ1)" format. The Size specifies the desired data contents.

Address: 0C 00 03
 Size: 00 mm pp mm = MAP# 01 - 02 (01 = SC-55 MAP, 02 = SC-88 MAP)
 pp = Drum set# 00 - 7F (same as PC#)

○ Drum instrument list dump (transmit only) [88]

When a Drum Instrument Dump Request is received, or when a dump is initiated by panel operation, the Drum Instrument names of the specified Drum Set will be transmitted in the following format where 16 bytes are used for each Drum Instrument name. The address of the transmitted data will be 0C 00 03 for each packet.

```
DUMP FORMAT:
  0 1 2 3 4 5 6 7 8 9 A B C D E F
-----
100|MAP|PC|KEY| DRUM TONE NAME(ASCII 12 characters) |
-----
MAP : MAP number 01 = SC-55 MAP, 02 = SC-88 MAP
PC : Program number
KEY : Note number
```

Section 5. Supplementary material

● Decimal and Hexadecimal table

In MIDI documentation, data values and addresses/sizes of exclusive messages etc. are expressed as hexadecimal values for each 7 bits. The following table shows how these correspond to decimal numbers.

Dec.	Hex.	Dec.	Hex.	Dec.	Hex.	Dec.	Hex.
0	00H	32	20H	64	40H	96	60H
1	01H	33	21H	65	41H	97	61H
2	02H	34	22H	66	42H	98	62H
3	03H	35	23H	67	43H	99	63H
4	04H	36	24H	68	44H	100	64H
5	05H	37	25H	69	45H	101	65H
6	06H	38	26H	70	46H	102	66H
7	07H	39	27H	71	47H	103	67H
8	08H	40	28H	72	48H	104	68H
9	09H	41	29H	73	49H	105	69H
10	0AH	42	2AH	74	4AH	106	6AH
11	0BH	43	2BH	75	4BH	107	6BH
12	0CH	44	2CH	76	4CH	108	6CH
13	0DH	45	2DH	77	4DH	109	6DH
14	0EH	46	2EH	78	4EH	110	6EH
15	0FH	47	2FH	79	4FH	111	6FH
16	10H	48	30H	80	50H	112	70H
17	11H	49	31H	81	51H	113	71H
18	12H	50	32H	82	52H	114	72H
19	13H	51	33H	83	53H	115	73H
20	14H	52	34H	84	54H	116	74H
21	15H	53	35H	85	55H	117	75H
22	16H	54	36H	86	56H	118	76H
23	17H	55	37H	87	57H	119	77H
24	18H	56	38H	88	58H	120	78H
25	19H	57	39H	89	59H	121	79H
26	1AH	58	3AH	90	5AH	122	7AH
27	1BH	59	3BH	91	5BH	123	7BH
28	1CH	60	3CH	92	5CH	124	7CH
29	1DH	61	3DH	93	5DH	125	7DH
30	1EH	62	3EH	94	5EH	126	7EH
31	1FH	63	3FH	95	5FH	127	7FH

* Decimal values such as MIDI channel, bank select, and program change are listed as one greater than the values given in the above table.

* A 7-bit byte can express data in the range of 128 steps. For data where greater precision is required, we must use two or more bytes. For example, two hexadecimal numbers aa bbH expressing two 7-bit bytes would indicate a value of aa x 128 + bb.

* In the case of values which have a ± sign, 00H = -64, 40H = ±0, and 7FH = +63, so that the decimal expression would be 64 less than the value given in the above chart. In the case of two types, 00 00H = -8192, 40 00H = ±0, and 7F 7FH = +8191. For example if aa bbH were expressed as decimal, this would be aa bbH - 40 00H = aa x 128 + bb - 64 x 128.

* Data marked "nibbled" is expressed in hexadecimal in 4-bit units. A value expressed as a 2-byte nibble 0a 0bH has the value of a x 16 + b.

<Example 1> What is the decimal expression of 5AH ?
 From the preceding table, 5AH = 90

<Example 2> What is the decimal expression of the value 12 34H given as hexadecimal for each 7 bits?
 From the preceding table, since 12H = 18 and 34H = 52
 18 x 128 + 52 = 2356

<Example 3> What is the decimal expression of the nibbled value 0A 03 09 0D ?
 From the preceding table, since 0AH = 10, 03H = 3, 09H = 9, 0DH = 13
 ((10 x 16 + 3) x 16 + 9) x 16 + 13 = 41885

<Example 4> What is the nibbled expression of the decimal value 1258?

```
16) 1258
   78 ... 10
   4 ... 14
   0 ... 4
```

Since from the preceding table, 0=00H, 4=04H, 14=0EH, 10=0AH, the answer is 00 04 0E 0AH

● **Examples of actual MIDI messages**

<Example 1> 92 3E 5F

9n is the Note-on status, and n is the MIDI channel number. Since 2H = 2, 3EH = 62, and 5FH = 95, this is a Note-on message with MIDI CH = 3, note number 62 (note name is D4), and velocity 95.

<Example 2> CE 49

CnH is the Program Change status, and n is the MIDI channel number. Since EH = 14 and 49H = 73, this is a Program Change message with MIDI CH = 15, program number 74 (Flute in GS).

<Example 3> EA 00 28

EnH is the Pitch Bend Change status, and n is the MIDI channel number. The 2nd byte (00H=0) is the LSB and the 3rd byte (28H=40) is the MSB, but Pitch Bend Value is a signed number in which 40 00H (= 64 x 128 + 0 = 8192) is 0, so this Pitch Bend Value is
 $28\ 00H - 40\ 00H = 40 \times 128 + 0 - (64 \times 128 + 0) = 5120 - 8192 = -3072$

If the Pitch Bend Sensitivity is set to 2 semitones, -8192 (00 00H) will cause the pitch to change -200 cents, so in this case $-200 \times (-3072) + (-8192) = -75$ cents of Pitch Bend is being applied to MIDI channel 11.

<Example 4> B3 64 00 65 00 06 0C 26 00 64 7F 65 7F

BnH is the Control Change status, and n is the MIDI channel number. For Control Changes, the 2nd byte is the control number, and the 3rd byte is the value. In a case in which two or more messages consecutive messages have the same status, MIDI has a provision called "running status" which allows the status byte of the second and following messages to be omitted. Thus, the above messages have the following meaning.

B3	64 00	MIDI ch.4, lower byte of RPN parameter number	: 00H
(B3)	65 00	(MIDI ch.4) upper byte of RPN parameter number	: 00H
(B3)	06 0C	(MIDI ch.4) upper byte of value	: 0CH
(B3)	26 00	(MIDI ch.4) lower byte of value	: 00H
(B3)	64 7F	(MIDI ch.4) lower byte of RPN parameter number	: 7FH
(B3)	65 7F	(MIDI ch.4) upper byte of RPN parameter number	: 7FH

In other words, the above messages specify a value of 0C 00H for RPN parameter number 00 00H on MIDI channel 4, and then set the RPN parameter number to 7F 7FH.

RPN parameter number 00 00H is Pitch Bend Sensitivity, and the MSB of the value indicates semitone units, so a value of 0CH = 12 sets the maximum pitch bend range to ± 2 semitones (1 octave). (On GS sound sources the LSB of Pitch Bend Sensitivity is ignored, but the LSB should be transmitted anyway (with a value of 0) so that operation will be correct on any device.

Once the parameter number has been specified for RPN or NRPN, all Data Entry messages transmitted on that same channel will be valid, so after the desired value has been transmitted, it is a good idea to set the parameter number to 7F 7FH to prevent accidents. This is the reason for the (B3) 64 7F (B3) 65 7F at the end.

It is not desirable for performance data (such as Standard MIDI File data) to contain many events with running status as given in <Example 4>. This is because if playback is halted during the song and then reworded or fast-forwarded, the sequencer may not be able to transmit the correct status, and the sound source will then misinterpret the data. Take care to give each event its own status.

It is also necessary that the RPN or NRPN parameter number setting and the value setting be done in the proper order. On some sequencers, events occurring in the same (or consecutive) clock may be transmitted in an order different than the order in which they were received. For this reason it is a good idea to slightly skew the time of each event (about 1 tick for TPQN=96, and about 5 ticks for TPQN=480).

* TPQN : Ticks Per Quarter Note

● **Example of an Exclusive message and calculating a Checksum**

Roland Exclusive messages (RQ1, DT1) are transmitted with a checksum at the end (before F7) to make sure that the message was correctly received. The value of the checksum is determined by the address and data (or size) of the transmitted exclusive message.

◇ **How to calculate the checksum (hexadecimal numbers are indicated by 'H')**

The checksum is a value derived by adding the address, size and checksum itself and inverting the lower 7 bits.

Here's an example of how the checksum is calculated. We will assume that in the exclusive message we are transmitting, the address is aa bb ccH and the data or size is dd ee fH.

$$aa + bb + cc + dd + ee + ff = \text{sum}$$

$$\text{sum} + 128 = \text{quotient} \dots \text{remainder}$$

$$128 - \text{remainder} = \text{checksum}$$

<Example 1> Setting REVERB MACRO to ROOM 3

According to the "Parameter Address Map", the REVERB MACRO Address is 40 01 30H, and ROOM 3 is a value of 02H. Thus,

F0	41	10	42	12	40 01 30	02	22	F7
(1)	(2)	(3)	(4)	(5)	address	data	checksum	(6)

(1) Exclusive Status (2) ID (Roland) (3) Device ID (17)
 (4) Model ID (GS) (5) Command ID (RT1) (6) End of Exclusive

Next we calculate the checksum.

$$40H + 01H + 30H + 02H = 64 + 1 + 48 + 2 = 115(\text{sum})$$

$$115(\text{sum}) + 128 = 0(\text{quotient}) \dots 115(\text{remainder})$$

$$\text{checksum} = 128 - 115(\text{remainder}) = 13 = 0DH$$

This means that F0 41 10 42 12 40 01 30 02 0D F7 is the message we transmit.

<Example 2> Requesting transmission of the LEVEL for DRUM MAP 1 NOTE NUMBER 75 (D#5; Claves)

NOTE NUMBER 75(D#5) is 4BH in hexadecimal.
 According to the "Parameter Address Map", LEVEL of NOTE NUMBER 75 (D#5; Claves) in DRUM MAP 1 has an Address of 41 02 4BH and a Size of 00 00 01H. Thus,

F0	41	10	42	11	41 02 4B	00 00 01	22	F7
(1)	(2)	(3)	(4)	(5)	address	size	checksum	(6)

(1) Exclusive Status (2) ID (Roland) (3) Device ID (17)
 (4) Model ID (GS) (5) Command ID (RQ1) (6) End of Exclusive

Next we calculate the checksum.

$$41H + 02H + 4BH + 00H + 00H + 01H = 65 + 2 + 75 + 0 + 0 + 1 = 143(\text{sum})$$

$$143(\text{sum}) + 128 = 1(\text{quotient}) \dots 15(\text{remainder})$$

$$\text{checksum} = 128 - 15(\text{remainder}) = 113 = 71H$$

This means that F0 41 10 42 11 41 02 4B 00 00 01 71 F7 is the message we transmit.

● About tuning

In MIDI, individual Parts are tuned by sending RPN #1 (Master Fine Tuning) to the appropriate MIDI channel.

In MIDI, an entire device is tuned by either sending RPN #1 to all MIDI channels being used, or by sending a System Exclusive MASTER TUNE (address 40 00 00H).

RPN #1 allows tuning to be specified in steps of approximately 0.012 cents (to be precise, 100/8192 cent), and System Exclusive MASTER TUNE allows tuning in steps of 0.1 cent. One cent is 1/100th of a semitone.

The values of RPN #1 (Master Fine Tuning) and System Exclusive MASTER TUNE are added together to determine the actual pitch sounded by each Part.

Frequently used tuning values are given in the following table for your reference. Values are in hexadecimal (decimal in parentheses).

Hz at A4	cent	RPN #1	Sys. Ex. 40 00 00
445.0	+19.56	4C 43 (+1603)	00 04 0C 04 (+196)
444.0	+15.67	4A 03 (+1283)	00 04 09 0D (+157)
443.0	+11.76	47 44 (+ 964)	00 04 07 06 (+118)
442.0	+ 7.85	45 03 (+ 643)	00 04 04 0F (+ 79)
441.0	+ 3.93	42 42 (+ 322)	00 04 02 07 (+ 39)
440.0	0	40 00 (0)	00 04 00 00 (0)
339.0	- 3.94	3D 3D (- 323)	00 03 0D 09 (- 39)
338.0	- 7.89	3A 7A (- 646)	00 03 0B 01 (- 79)

<Example 1> Set the tuning of MIDI channel 3 to A4 = 442.0Hz
Send RPN#1 to MIDI channel 3. From the above table, the value is 45 03H.

B2	64 00	MIDI ch.3, lower byte of RPN parameter number	:00H
(B2)	65 01	(MIDI ch.3) upper byte of RPN parameter number	:01H
(B2)	06 45	(MIDI ch.3) upper byte of value	:45H
(B2)	26 03	(MIDI ch.3) lower byte of value	:03H
(B2)	64 7F	(MIDI ch.3) upper byte of RPN parameter number	:7FH
(B2)	65 7F	(MIDI ch.3) lower byte of RPN parameter number	:7FH

<Example 2> Set the tuning of the entire device to +23.4 cent
From the "Parameter Address Map", the MASTER TUNE Address is 40 00 00H.
The value is expressed nibbled in steps of 0.1 cent with 00 04 00 00H (= 1024) as 10, so +23.4 cent would be 234 + 1024 = 1258, and when this is nibbled it would be 00 04 0E 0AH.

Er	41	10	12	12	40 00 00	00 04 0E 0A	22	E7
(1)	(2)	(3)	(4)	(5)	address	data	checksum	(6)
(1)Exclusive Status	(2)ID (Roland)	(3)Device ID (17)	(4)Model ID (GS)	(5)Command ID (DT1)	(6)End of Exclusive			

Next we calculate the checksum.
40H + 00H + 00H + 00H + 04H + 0EH + 0AH = 64 + 0 + 0 + 0 + 4 + 14 + 10 = 92(sum)
92(sum) + 128 = 0(quotient) ... 92(remainder)
checksum = 128 - 92(remainder) = 36 = 24H

This means that F0 41 10 42 12 40 00 00 00 04 0E 0A 24 F7 is the message we transmit.

● The Scale Tune Feature (address : 40 1x 40)

The scale Tune feature allows you to finely adjust the individual pitch of the notes from C through B. Though the settings are made while working with one octave, the fine adjustments will affect all octaves. By making the appropriate Scale Tune settings, you can obtain a complete variety of tuning methods other than equal temperament. As examples, three possible types of scale setting are explained below.

○ Equal Temperament

This method of tuning divides the octave into 12 equal parts. It is currently the most widely used form of tuning, especially in occidental music. On the SC-88, the default settings for the Scale Tune feature produce equal temperament.

○ Just Temperament (Keytone C)

The three main chords resound much more beautifully than with equal temperament, but this benefit can only be obtained in one key. If transposed, the chords tend to become ambiguous. The example given involves settings for a key in which C is the keytone.

○ Arabian Scale

By altering the setting for Scale Tune, you can obtain a variety of other tunings suited for ethnic music. For example, the settings introduced below will set the unit to use the Arabian Scale.

Example Settings

Note name	Equal Temperament	Just Temperament (Keytone C)	Arabian Scale
C	0	0	-6
C#	0	-8	+45
D	0	+4	-2
D#	0	+16	-12
E	0	-14	-51
F	0	-2	-8
F#	0	-10	+43
G	0	+2	-4
G#	0	+14	+47
A	0	-16	0
A#	0	+14	-10
B	0	-12	-49

The values in the table are given in cents. Refer to the explanation of Scale Tuning on page 7-30 to convert these values to hexadecimal, and transmit them as exclusive data to the SC-88.

For example, to set the tune (C-B) of the Part1 Arabian Scale, send the data as follows:

F0 41 10 42 12 40 11 40 3A 6D 3E 34 0D 38 6B 3C 6F 40 36 0F 50 F7

MIDI Implementation Chart

Function...	Transmitted	Recognized	Remarks
Basic Channel Default Changed	X X	1-16 1-16	Memorized
Mode Default Message Altered	X X *****	Mode 3 Mode 3, 4(M=1)	*2
Note Number : True Voice	X *****	0-127 0-127	
Velocity Note ON Note OFF	X X	O X	
After Touch Key's Ch's	X X	O *1 O *1	
Pitch Bend	X	O *1	
Control Change 0, 32 1 5 6, 38 7 10 11 64 65 66 67 84 91 93 94 98, 99 100, 101	X X	O *1 O *1 O *1 O *1 O *1 O *1 O *1 O *1 O *1 O *1 O *1 O *1 O *1 O *1 O *1 O *1 O *1 O *1 O *1 X *1 O *1	Bank select Modulation Portamento time Data entr Volume Pan Expression Hold 1 Portamento Sostenuto Soft Portamento control Effect 1 (Reverb Send Level) Effect 3 (Chorus Send Level) Effect 4 (Delay Send Level) NRPN LSB,MSB RPN LSB,MSB
Program Change : True #	X *****	O *1 0-127	Program Number: 1-128
System Exclusive	O	O	
System : Song Pos Common : Song Sel : Tune	X X X	X X X	
System : Clock Real Time : Commands	X X	X X	
Aux Messages : All Sounds OFF : Reset All Controllers : Local ON/OFF : All Notes OFF : Active Sensing : Reset	X X X X O X	O (120,126,127) O X O (123-125) O X	
Notes	*1 O X is selectable. *2 Recognize as M=-1 even if M ≠ 1		

Mode 1 : OMNI ON, POLY
Mode 3 : OMNI OFF, POLY

Mode 2 : OMNI ON, MONO
Mode 4 : OMNI OFF, MONO

O : Yes
X : No

INDEX

[A]

Active Sensing	6-7
Aftertouch	6-6
All Note Off	6-7
All Sound Off	6-7
Apple Macintosh Series	5-2
Assign Group	2-30
Attack Time	2-20
Audio Input	1-9

[B]

Backup Switch	2-25
Bank Select	5-9, 6-4
Bar Indicator	1-3
Battery	0-3
Bend Range	2-14
Bulk Dump Data	4-10

[C]

Caf	
LFO Rate	2-16
LFO Pitch	2-16
LFO TVF	2-16
LFO TVA	2-16
Capital	2-4
Channel	2-7, 6-3
Channel Pressure	6-6
Chorus	
All Chorus	3-4
Part Chorus	1-7, 3-4
Chorus Delay	3-8
Chorus Depth	3-8
Chorus Feedback	3-8
Chorus Level	3-8
Chorus Pre-LPF	3-8
Chorus Rate	3-8
Chorus Send Level	6-5
Chorus Send Level To Reverb	3-8
Chorus Send Level To Delay	3-8
Chorus Type	3-6
CM-64	4-14
Control Change	6-5
Contrast (Display)	2-27
Computer Cable	5-2, 7-5
Computer Switch	5-3
Cutoff Frequency	2-19

[D]

Data Entry	6-6
Decay Time	2-20
Delay	
All Delay	3-4
Part Delay	1-7, 3-4
Delay Feedback	3-9
Delay Level	3-9
Delay Level Center	3-9
Delay Level Left	3-9
Delay Level Right	3-9
Delay Pre-LPF	3-9
Delay Send Level	6-5
Delay Send Level To Reverb	3-9
Delay Time Center	3-9
Delay Time Ratio Left	3-9
Delay Time Ratio Right	3-9

Delay Type	3-6
Device ID	6-9
Display	2-26
Display Contrast	2-27
Double Module Mode	4-16
Drum Edit	2-28
Drum Part	2-2
Drum Set	2-2
Dump Data	4-10

[E]

Effect	3-1
EQ	1-7, 3-2
Master EQ	2-23
Part EQ	2-13
EQ Lock	6-15
Error Message	7-4
Exclusive Message	6-8
Expression	6-5

[F]

Factory Preset	4-18
Fine Tune	2-13
Frame Draw	4-12

[G]

GM Initialize	4-18
GM System	6-17
GM System On	6-8
GS Format	6-17
GS Initialize	4-18
GS Reset	6-8

[H]

Headphones	1-9
Hi Frequency	3-3
Hi Gain	3-3
Hold 1	6-5

[I]

IBM PC/AT	5-2
IN B Select	6-10
Initialization	4-18
Input Modes	6-12
Instrument	1-4, 2-2

[K]

Key Pressure	6-6
Keyboard Range H	2-14
Keyboard Range L	2-14
Key Shift	
Master Key Shift	2-22
Part Key Shift	1-7, 2-12

[L]

LCD Contrast	2-27
Level	
Master Level	2-22
Part Level	1-7, 2-12
Low Frequency	3-3
Low Gain	3-3

[M]	
Maximum Polyphony	2-9
Mono/Poly Mode	2-13
Master Tune	1-8
MIDI	6-2
MIDI Implementation	7-21
MIDI Implementation chart	7-37
MIDI IN B	6-10
MIDI Channel	2-7, 6-3
MIDI Connector	6-2
Modulation	6-5
Modulation Depth	2-14
Monitor	2-2
Mono	2-13
Multi-Timbral Sound Module	2-2
Mute	
All Mute	2-22
Part Mute	2-12
Mute Lock	6-14
[N]	
Normal Part	2-13
Note Message	6-4
Note Name	6-4
Note Number	6-4
NRPN	6-6
[O]	
OUT/THRU Select	6-11
[P]	
Pan	6-5
Master Pan	2-22
Part Pan	1-6, 2-12
Part	2-7
Part Mode	2-13
Part Parameter	2-10, 2-17
Peak Hold	2-26
Pitch Bend Change	6-4
Pitch Coarse	2-29
Poly	2-13
Polyphonic Key Pressure	6-6
Portamento	6-6
Portamento Control	6-6
Portamento Time	6-6
Positioning	2-12, 2-22
Power	1-2
Preview Note Name	1-5, 2-25
Preview Velocity	1-5, 2-25
Program Change	5-9, 6-4
[R]	
Release Time	2-20
Reset All Controllers	6-7
Resonance	2-19
Reverb	
All Reverb	3-4
Part Reverb	1-7, 3-4
Reverb Character	3-7
Reverb Delay Feedback	3-7
Reverb Level	3-7
Reverb Pre-Delay Time	3-7
Reverb Pre-LPF	3-7
Reverb Send Level	6-5
Reverb Time	3-7
Reverb Type	3-6
RPN	6-6
Rx.Bank sel	6-16
Rx.GM On	6-15
Rx.GS Reset	6-15
Rx.NRPN	6-16
RX.SysMode	2-27, 6-12
[S]	
SC-55MAP	
All SC-55MAP	2-21
Part SC-55MAP	2-12
SFX	7-12, 7-14, 7-18, 7-20
Single Module Mode	4-16
Soft	6-5
Sostenuto	6-5
System Exclusive Message	6-8
System Mode Set receive switch	2-27, 6-12
[T]	
Troubleshooting	7-4
Tuning	1-8
THRU	5-7, 6-2
THRU Function	5-5
[U]	
User Instrument Edit	4-2
User Drum Edit	4-5
[V]	
Velocity Sens Depth	2-15
Velocity Sens Offset	2-15
Vibrato Delay	2-18
Vibrato Depth	2-18
Vibrato Rate	2-18
Voice	2-9
Volume	6-5
Variation	2-4

■ Specifications

Model : Sound Canvas SC-88
(General MIDI System  /GS format )

● Number of parts

32

● Maximum Polyphony

64 (voices)

● Internal Memory

Sound map : 2 (SC-55, SC-88)
Preset sounds : 654
Drum sound set : 24 (include 2 SFX Set)
User sounds : 256
User drum sound set : 2

● Effects

Reverb (8type)
Chorus (8type)
Delay (10type)
2 band equalizer

● Display

70.6 x 24.5mm (backlit LCD)

● Connectors

MIDI connectors
(IN A, IN B Front/Rear, OUT/THRU)
Audio Input jack x 2 (L,R)
Input Volume Knob
Audio Output jack x 2 (L,R)
Headphones jack
Computer terminal
Computer Switch

● Power Supply

AC117V, AC230V or 240V

● Power Consumption

14W (AC117V), 18W (230V/240V)

● Dimensions

218 (W) x 250 (D) x 72 (H) mm
8-5/8 (W) x 9-7/8 (D) x 2-7/8 (H) inches

● Weight

2.6 kg
5 lbs 12 oz

● Accessories

Owner's manual
MIDI cable (1m) x 1
Audio Cable
(RCA pin ↔ RCA pin<1/4 inch phone type>)

* *The included MIDI cable is for MIDI only. It cannot be used for other purposes.*

● Options

Computer cable
RSC-15AT (For IBM PC/AT series)
RSC-15ARL (For Apple Macintosh series)

* *The specifications for this product are subject to change without prior notice.*

■ How to use the included floppy disk for the SC-88

The SC-88 comes with a floppy disk containing demo song data. This floppy disk contains data in Standard MIDI File (SMF) format and also data in Super-MRC format (used in MC series sequencers such as the Roland MC-50mkII). If you wish to playback the demo songs on your computer, use the Standard MIDI File data. If you wish to playback the demo songs on a MC series sequencer (MC-50mkII, MC-50, MC-500mkII, etc.), use the Super-MRC data. For details on how to convert the data (SMF Import) and playback the demo songs, refer to the operating instructions for your software or MIDI device.

Some of the songs in this floppy disk use 32 Parts in order to take fullest advantage of the SC-88's capabilities. (These songs are marked * in the list below.) In order to playback these songs, you will need a sequencer or software that can read Standard MIDI File Format 1 and can handle 32 Parts in separate groups of 16 channels. Sequencers with only one MIDI OUT (such as the Roland SB-55) cannot playback these songs. For Super-MRC data, track 1 will be assigned for output from MIDI OUT 1, and track 2 for output from MIDI OUT 2.

● Demo songs

File name	Song title	Composer
Y4002_01.MID	Brass Nation	* Yasuhiko Komuro Copyright © 1994, Roland Corporation
Y4002_02.MID	Myth	* Masashi Hirashita, Kazuko Hirashita Copyright © 1994, Roland Corporation
Y4002_03.MID	Skatey Eight	Adrian Scott Copyright © 1994, Adrian Scott
Y4002_04.MID	TOXOPLASMA	Mitsuru Sakaue, Kazunori Seki Copyright © 1994, Roland Corporation
Y4002_05.MID	Opus 88	* Marvin Sanders Copyright © 1994, Marvster Music
Y4002_06.MID	Idaten	* Hiroshi Hisamitsu Copyright © 1994, Roland Corporation
Y4002_07.MID	Mid Night Chaser	* Kyouko Ootagawa Copyright © 1994, Roland Corporation

Warning : All rights reserved. Unauthorized use of this material is a violation of applicable laws.

● Notes for Apple Macintosh users

- (1) Convert the files of the included floppy disk (MS-DOS format) into Macintosh file format using the file conversion program "Apple File Exchange" that is included with the Macintosh.
- (2) Change the File Type of the converted files. Use ResEdit (Apple Computer Inc.) or an equivalent program to change the File Type to "Midi".

- * Apple is a registered trademark of Apple Computer, Inc.
- * Macintosh is a trademark of Apple Computer, Inc.
- * MS-DOS is a registered trademark of Microsoft, Inc.
- * Other trademarks or registered trademarks appearing in this publication are the property of their license holders.

■ Profile of composers

Yasuhiko Komuro

Yasuhiko Komuro is a freelance classical composer/arranger/pianist who lives in the Kansai area. In 1990 he joined Kyouko Ootagawa and Hisamitsu Hiroshi to form "Team-khy", and their compositions in their own solid style are highly acclaimed.

Masashi Hirashita / Kazuko Hirashita

Masashi and Kazuko both started studying classical piano when they were in their infancy. Both went on to study composition. At the same time, they had started their own music careers as keyboardists and composers. Their work covers a wide spectrum of styles and activities, including pop, fusion and jazz music as well as many writing and producing jobs.

Adrian Scott

Adrian Scott formerly handled the vocals and keyboards for the popular Australian group, "Air Supply." Since following the solo path, he won the Silver Prize at the "World Song Festival Tokyo '84." Currently, he is involved as a producer of commercial music and music for films. In addition, as a session player, he has performed along with a number of Australia's top musicians, including John Farnham and Kylie Minogue. He lives in Melbourne, Australia.

Mitsuru Sakaue

From his college days, Mitsuru Sakaue has been active as a keyboard player and arranger in studio and commercial music production. At present he is involved in production of commercials for TV and radio as a composer, arranger, keyboard player and computer music expert. His highly acclaimed musical abilities go beyond borders of musical genre. He is the chief director of the Idecs (Inc.) group of creative musical artists.

Kazunori Seki

Kazunori Seki is active as a session drummer. Beginning with his band debut on "Motoyoshi Iwasaki & WINDY" (on Kitty records), he participated in four singles and two LPs. When the group disbanded, he began freelancing as a composer. At present he is active as a composer and arranger of commercial music. Kazunori is a multi-talented musician who handles everything from arranging, vocals, computer operation, and engineering all by himself.

Marvin Sanders

Marvin Sanders is a Los Angeles-based composer whose music and sound design can be heard on projects for Toyota, FOX, Max Factor, Disney, Intel, Brian Wilson, and Michael Jackson. He has worked extensively with Roland, both as former US Keyboard Product Manager, and as an independent consultant involved in product development and international demonstrations. Contributions to other Roland instruments include ROM-plays in the RD-500, JD-990, and JV-880.

Hiroshi Hisamitsu

Since his schooldays, Hiroshi Hisamitsu has been active in orchestral composition and in arranging. He has also had an interest in computer music which led to compositions in that field as well. His compositional technique is supported by broad musical knowledge and experience, and he is especially known for his acoustic expressiveness. At present, he is a member of "Team-khy", and an instructor in computer music at Kyoto University of Education.

Kyouko Ootagawa

Ootagawa Kyouko is a composer with experience in music production for numerous events, TV broadcasts and concerts. Her wide range of talents includes computer music, and she adds a spot of feminine charm to the group "Team-khy." She is an instructor at Soai University.

Information

When you need repair service, call your local Roland Service Station or the authorized Roland distributor in your country as shown below.

U. S. A.

Roland Corporation US
7200 Dominion Circle
Los Angeles, CA. 90040-
3696, U. S. A.
TEL: (213) 685-5141

CANADA

Roland Canada Music Ltd.
(Head Office)
5480 Parkwood Way
Richmond B. C., V6V 2M4
CANADA
TEL: (604) 270-6626

Roland Canada Music Ltd.

(Montreal Office)
9425 Transcanadienne
Service Rd. N., St Laurent,
Quebec H4S 1V3, CANADA
TEL: (514) 335-2009

Roland Canada Music Ltd.

(Toronto Office)
346 Watline Avenue,
Mississauga, Ontario L4Z
1X2, CANADA
TEL: (416) 890-6488

AUSTRALIA

Roland Corporation Australia Pty. Ltd.
38 Campbell Avenue
Dee Why West. NSW 2099
AUSTRALIA
TEL: (02) 982-8266

NEW ZEALAND

Roland Corporation (NZ) Ltd.
97 Mt. Eden Road, Mt. Eden,
Auckland 3, NEW ZEALAND
TEL: (09) 3098-715

UNITED KINGDOM

Roland (U.K.) Ltd.
Rye Close Ancells Business
Park Fleet, Hampshire GU13
8UY, UNITED KINGDOM
TEL: 0252-816181

Roland (U.K.) Ltd., Swansea Office

Atlantic Close, Swansea
Enterprise Park, Swansea,
West Glamorgan SA79FJ,
UNITED KINGDOM
TEL: (0792) 700-139

IRELAND

The Dublin Service Centre Audio Maintenance Limited
11 Brunswick Place Dublin 2
Republic of Ireland
TEL: 010 353 1677322

ITALY

Roland Italy S. p. A.
Viale delle Industrie 8 20020
ARESE MILANO ITALY
TEL: 02-93581311

SPAIN

Roland Electronics de España, S. A.
Calle Bolivia 239 08020
Barcelona, SPAIN
TEL: 93-308-1000

GERMANY

Roland Elektronische Musikinstrumente Handelsgesellschaft mbH.
Oststrasse 96, 22844
Norderstedt, GERMANY
TEL: 040/52 60 090

FRANCE

Guillard Musiques Roland
ZAC de Rosarge Les Echets
01700
MIRIBEL FRANCE
TEL: (7) 226-50 60

Guillard Musiques Roland (Paris Office)

1923 rue Léon Geoffroy
94400 VITRY-SUR-SEINE
FRANCE
TEL: (1) 4680 86 62

BELGIUM/HOLLAND/LUXEMBOURG

Roland Benelux N. V.
Houtstraat 1 B-2260 Oevel-
Westerlo BELGIUM
TEL: (0032) 14-575811

DENMARK

Roland Scandinavia A/S
Langebrogade 6 Box 1937
DK-1023 Copenhagen K.
DENMARK
TEL: 31-95 31 11

SWEDEN

Roland Scandinavia A/S
Danvik Center 28 A, 2 tr.
S-131 30 Nacka SWEDEN
TEL: 08-702 00 20

NORWAY

Roland Scandinavia Avd. Kontor Norge
Lilleakerveien 2 Postboks 95
Lilleaker N-0216 Oslo 2
NORWAY
TEL: 22-73 00 74

FINLAND

Fazer Musik Inc.
Länsituulentie POR 169,
SF-02101 Espoo FINLAND
TEL: 0-43 50 11

SWITZERLAND

Roland CK (Switzerland) AG
Gerberstrasse 5, CH-4410
Liestal, SWITZERLAND
TEL: 061/921 16 15

AUSTRIA

E. Dematte & Co.
Neu-Rum Siemens-Strasse 4
A-6040 Innsbruck P.O.Box
83
AUSTRIA
TEL: (0512) 26 44 260

GREECE

V. Dimitriadis & Co. Ltd.
20, Alexandras Avn., GR
10682 Athens, GREECE
TEL: 01-8232415

PORTUGAL

Casa Caius Instrumentos Musicais Lda.
Rua de Santa Catarina 131
4000 Porto, PORTUGAL
TEL: 02-38 44 56

HUNGARY

Intermusica Ltd.
Warehouse Area 'DEPO'
Torokbalint, Budapest
HUNGARY
TEL: (1) 1868905

ISRAEL

D.J.A. International Ltd.
11 Bar Gyiora St., Tel Aviv
ISRAEL
TEL: 972-3-525-3834

CYPRUS

Radex Sound Equipment Ltd.
17 Diagorou St., P.O.Box
2046, Nicosia CYPRUS
TEL: 453426, 466423

U.A.E

Zak Electronics & Musical Instruments Co.
P.O. Box 8050
DUBAI, U.A.E
TEL: 9714-360715

KUWAIT

Easa Husain Al-Yousifi
P.O. Box 126 Safat 13002
KUWAIT
TEL: 965-5719499

LEBANON

A. Chahine & Fils
P.O. Box 16-5857
Beirut, LEBANON
TEL: 335799

TURKEY

Barkat Sanayi ve Ticaret
Sirasevler Cad. 86/6 Taksim
Istanbul, TURKEY
TEL: 212-2499324

EGYPT

Al Fanny Trading Office
9, Ebn Hagar Al Askalany
Street, Ard El Golf,
Heliopolis, Cairo, 11341
EGYPT
TEL: 2917803-665918

QATAR

Badie Studio & Stores
P.O.Box 62,
DOHA Qatar
TEL: 974 423554

BAHRAIN

Moon Stores
Bad Al Bahrain Road,
P.O.Box 20077
State of Bahrain
TEL: (0973) 211 005

BRAZIL

Roland Brasil Ltda.
R. Coronel Oaviano da
Silveira 203 05522-010
Sao Paulo BRAZIL
TEL: (011) 843-9377

MEXICO

Casa Veerkamp, s.a. de c.v.
Mesones No. 21 Col. Centro
MEXICO D.F. 06080
TEL: (5) 709-3716

La Casa Wagner de Guadalajara s.a. de c.v.

Av. Corona No. 202 S.I.
C.P.44100 Guadalajara,
Jalisco MEXICO
TEL: (36) 13-1414

VENEZUELA

Musicland Digital C.A.
Av. Francisco De Miranda,
Centro Parque de Cristal,
Nivel C2 Local 20 Caracas
VENEZUELA
TEL: (2)285-9218

PANAMA

Productos Superiores, S.A.
Apartado 655 - Panama 1
REP. DE PANAMA
TEL: 26-3322

ARGENTINA

Instrumentos Musicales S.A.
Florida 638
(1005) Buenos Aires
ARGENTINA
TEL: (1)394-4029

HONG KONG

Tom Lee Music Co., Ltd. Service Division
22-32 Pun Shan Street, Tsuen
Wan, New Territories,
HONG KONG
TEL: 415-0911

KOREA

Cosmos Corporation Service Station
261 2nd Floor Nak-Won
Arcade Jong-Ro ku, Seoul,
KOREA
TEL: (02) 742 8844

SINGAPORE

Swee Lee Company
BLOCK 231,
Bain Street #03-23
Bras Basah Complex,
Singapore 0718
TEL: 3367886

PHILIPPINES

G.A. Yupangco & Co. Inc.
339 Gil J. Puyat Avenue
Makati, Metro Manila 1200,
PHILIPPINES
TEL: 02 (817) 0013

THAILAND

Theera Music Co., Ltd.
330 Verng Nakorn Kasem,
Soi 2, Bangkok 10100,
THAILAND
TEL: 2248821

MALAYSIA

Bentley Music SDN BHD
No.142, Jalan Bukit Bintang
55100 Kuala Lumpur,
MALAYSIA
TEL: (03) 2443333

INDONESIA

PT CITRARAMA BELANTIKA
Kompleks Perkantoran Duta
Merlin Blok E No.6—7
Jl. Gajah Mada No.3—5,
Jakarta 10130,
INDONESIA
TEL: (021) 3850073

TAIWAN

Siruba Enterprise (Taiwan) Co., LTD.
Room. 5, 9fl. No. 112 Chung
Shan N.Road Sec.2 Taipei,
TAIWAN, R.O.C.
TEL: (02) 571-5860

SOUTH AFRICA

That Other Music Shop (PTY) Ltd.
11 Melle Street (Cnr Melle
and Juta Street)
Braamfontein 2001
Republic of South Africa
TEL: 27 11 403-4105

Paul Bothner (PTY) Ltd.

17 Werdmuller Centre
Claremont 7700
Republic of South Africa
TEL: 021-64-4030

As of April. 14. 1994

For Nordic Countries

Apparatus containing Lithium batteries

ADVARSEL!

Lithiumbatteri - Eksplosjonsfare ved feilagtig håndtering.
Udskiftning må kun ske med batteri af samme fabrikat og type.
Levér det brugte batteri tilbage til leverandøren.

VARNING!

Explosionsfara vid felaktigt batteribyte.
Använd samma batterityp eller en ekvivalent typ som rekommenderas av apparatillverkaren.
Kassera använt batteri enligt fabrikantens instruktion.

ADVARSEL!

Lithiumbatteri - Eksplosjonsfare.
Ved utskifting benyttes kun batteri som anbefalt av apparatfabrikanten.
Brukt batteri returneres apparatleverandøren.

VAROITUS!

Paristo voi räjähtää, jos se on virheellisesti asennettu.
Vaihda paristo ainoastaan laitevalmistajan suosittelemaan tyyppiin. Hävitä käytetty paristo valmistajan ohjeiden mukaisesti.

For Germany

Bescheinigung des Herstellers/Importeurs

Hiermit wird bescheinigt, daß der/die/das
MIDI SOUND GENERATOR SC-88

(Gerät, Typ, Bezeichnung)

in Übereinstimmung mit den Bestimmungen der BMPT-AmtsblVfg 243/1991 funk-entstört ist. Der vorschriftsmäßige Betrieb mancher Geräte (z. B. Meßsender) kann allerdings gewissen Einschränkungen unterliegen. Beachten Sie deshalb die Hinweise in der Bedienungsanleitung.

Dem Zentralamt für Zulassungen im Fernmeldewesen wurde das Inverkehrbringen dieses Gerätes angezeigt und die Berechtigung zur Überprüfung der Serie auf die Einhaltung der Bestimmungen eingeräumt.

Roland Corporation

4-16 Dojimahama 1-Chome Kita-ku Osaka 530 Japan

(Name und Anschrift des Herstellers/Importeurs)

For the USA

FEDERAL COMMUNICATIONS COMMISSION RADIO FREQUENCY INTERFERENCE STATEMENT

This equipment has been tested and found to comply with the limits for a Class B digital device, pursuant to Part 15 of the FCC Rules. These limits are designed to provide reasonable protection against harmful interference in a residential installation. This equipment generates, uses, and can radiate radio frequency energy and, if not installed and used in accordance with the instructions, may cause harmful interference to radio communications. However, there is no guarantee that interference will not occur in a particular installation. If this equipment does cause harmful interference to radio or television reception, which can be determined by turning the equipment off and on, the user is encouraged to try to correct the interference by one or more of the following measures:

- Reorient or relocate the receiving antenna.
- Increase the separation between the equipment and receiver.
- Connect the equipment into an outlet on a circuit different from that to which the receiver is connected.
- Consult the dealer or an experienced radio/TV technician for help.

Unauthorized changes or modification to this system can void the users authority to operate this equipment.
This equipment requires shielded interface cables in order to meet FCC class B Limit.

For Canada

CLASS B

NOTICE

This digital apparatus does not exceed the Class B limits for radio noise emissions set out in the Radio Interference Regulations of the Canadian Department of Communications.

CLASSE B

AVIS

Cet appareil numérique ne dépasse pas les limites de la classe B au niveau des émissions de bruits radioélectriques fixés dans le Règlement des signaux parasites par le ministère canadien des Communications.

Roland®

70233089

UPC

70233089



10981

